

UNCLASSIFIED
~~RESTRICTED~~

FM 23-15

C-2

U
408
A2

MHI
Copy 3

FM 23-15 AR DEPARTMENT

BASIC FIELD MANUAL

BROWNING AUTOMATIC RIFLE

CALIBER .30, M1918A2

30 June 1943

U.S. Army Military History Institute

~~RESTRICTED~~

Auth: NND 785097

By NNHP - NARS 11-3-78

REGRADED UNCLASSIFIED BY
AUTHORITY OF DOD DIR. 5200.1 R
BY B. M. S. ON 12/26/85

UNCLASSIFIED

FM 23-15

BASIC FIELD MANUAL

BROWNING AUTOMATIC RIFLE

CALIBER .30, M1918A2



**UNITED STATES
GOVERNMENT PRINTING OFFICE
WASHINGTON : 1943**

UNCLASSIFIED

90 15853
PROPERTY OF U. S.

WAR DEPARTMENT,
WASHINGTON 25, D. C., 30 June 1943.

FM 23-15, Browning Automatic Rifle, Caliber .30, M1918A2,
is published for the information and guidance of all concerned.

[A. G. 300.7 (5 May 43).]

BY ORDER OF THE SECRETARY OF WAR:

G. C. MARSHALL,
Chief of Staff.

OFFICIAL:

J. A. ULIO,
*Major General,
The Adjutant General.*

DISTRIBUTION:

B 7 (2); R 3, 7 (10); Bn 3, 7 (5); C 7 (5), 9 (2); IC 3
(5), 7 (15).

(For explanation of symbols see FM 21-6.)

U
408.3
A1
FM 23-15

TABLE OF CONTENTS

	Paragraphs	Page
CHAPTER 1. Mechanical training.		
SECTION I. General -----	1-3	1
II. Disassembly and assembly-----	4-12	3
III. Care and cleaning-----	13-16	16
IV. Functioning-----	17-28	25
V. Operation-----	29-37	37
VI. Stoppages and immediate action--	38-41	41
VII. Spare parts and accessories-----	42-43	44
VIII. Ammunition-----	44-51	48
CHAPTER 2. Marksmanship, known distance targets.		
SECTION I. General -----	52-54	53
II. Preparatory marksmanship training-----	55-80	54
III. Courses to be fired-----	81-83	86
IV. Range practice-----	84-93	94
V. Regulations governing record practice-----	94-124	100
VI. Targets and ranges-----	125-126	112
CHAPTER 3. Marksmanship, moving ground targets.		
SECTION I. General -----	127-128	117
II. Moving vehicles-----	129-131	118
III. Moving personnel-----	132-133	119
IV. Moving targets, ranges, and range precautions-----	134-135	121
CHAPTER 4. Marksmanship, aerial targets.		
SECTION I. Nature of aerial targets for automatic rifles -----	136-137	124
II. Technique of fire-----	138-142	124
III. Marksmanship training-----	143-147	129
IV. Miniature range practice-----	148-151	142
V. Towed target and radio-controlled plane target firing-----	152-156	146
VI. Ranges, targets, and equipment--	157-162	152
CHAPTER 5. Technique of fire.		
SECTION I. General -----	163-165	163
II. Range estimation-----	166-170	164
III. Target designation-----	171-174	169
IV. Automatic rifle fire and its effect--	175-181	181
V. Application of fire-----	182-189	186
VI. Landscape target firing-----	190-197	199
VII. Field target firing-----	198-201	211
VIII. Destruction of ordnance matériel--	202	228
CHAPTER 6. Advice to instructors.		
SECTION I. Mechanical training -----	203-211	231
II. Marksmanship, known distance targets-----	212-225	242
III. Marksmanship, aerial targets-----	226-230	258
IV. Technique of fire-----	231-240	262
CHAPTER 7. Safety precautions -----	241	272
INDEX -----		277

BASIC FIELD MANUAL

BROWNING AUTOMATIC RIFLE, CALIBER .30, M1918A2

This manual supersedes FM 23-15, 27 Aug. 1940; including C 1, 15 July 1941; C 2, 15 Nov. 1941; C 3, 10 July 1942; C 4, 5 Nov. 1942; and C 5, 18 Dec. 1942.

Attention is directed to FM 21-7 for details as to how appropriate training films and film strips are intended to be used and how they are made available for use during training with the Browning automatic rifle, caliber .30, M1918A2.

CHAPTER 1

MECHANICAL TRAINING

	Paragraphs
SECTION I. General.....	1-3
II. Disassembly and assembly.....	4-12
III. Care and cleaning.....	13-16
IV. Functioning.....	17-28
V. Operation.....	29-37
VI. Stoppages and immediate action.....	38-41
VII. Spare parts and accessories.....	42-43
VIII. Ammunition.....	44-51

SECTION I

GENERAL

■ 1. OBJECT.—This chapter is designed to give the soldier training that will insure his ability to maintain the rifle and keep it in operation.

■ 2. DESCRIPTION.—The Browning automatic rifle, caliber .30, M1918A2, is an air-cooled, gas-operated, magazine-fed shoulder weapon with bipod (fig. 1). It weighs approximately 20 pounds with sling. The ammunition is loaded in magazines of 20 rounds. The weight of the magazine when empty is 7 ounces; when filled, 1 pound 7 ounces.

■ 3. FIRE POWER.—The Browning automatic rifle, caliber .30, M1918A2, is not mechanically capable of semiautomatic fire, though it can be fired single shot by proper trigger manipu-

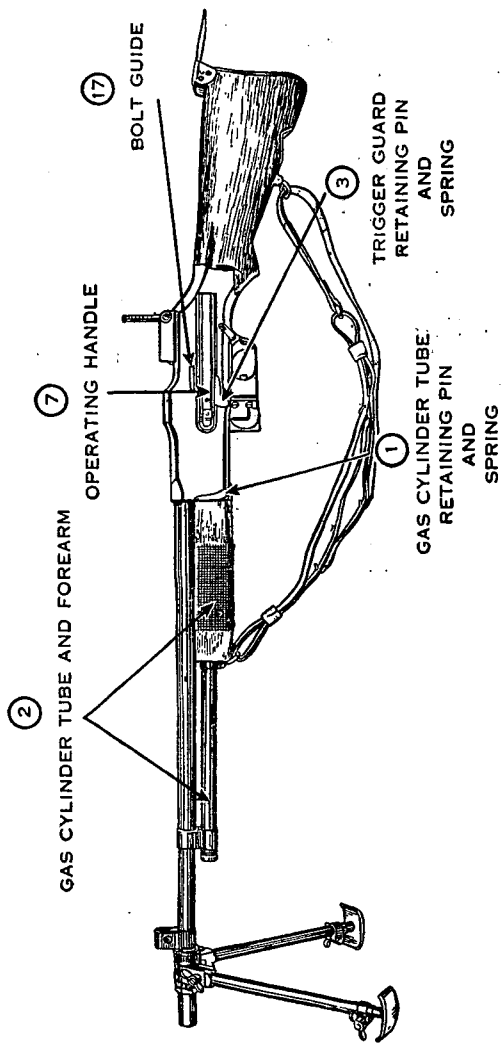

FIGURE 1.—Browning automatic rifle, caliber .30, M1918A2.

lation. There are two cyclic rates of full automatic fire, normal and slow, which may be selected by the firer. The normal cyclic rate is approximately 550 rounds per minute; the slow cyclic rate is approximately 350 rounds per minute. The most effective rate of fire for this weapon is from 120 to 150 rounds per minute. The sustained rate, however, is from 40 to 60 rounds per minute.

SECTION II

DISASSEMBLY AND ASSEMBLY

■ 4. TRAINING.—Training in disassembly and assembly will be taken up as soon as practicable after the soldier receives his rifle. In any case, it will be completed before any firing is done with the rifle by the individual. Instruction in the care and cleaning of the automatic rifle will also be covered.

■ 5. ORGANIZATION.—In the company or platoon, all enlisted men of the automatic rifle teams are combined in one or more groups, for instruction, under selected officer and non-commissioned officer instructors. Rifle squad leaders or assistant squad leaders supervise the work of their respective automatic rifle teams.

■ 6. CARE TO BE EXERCISED.—*a.* The rifle can normally be disassembled and assembled without applying undue force. When undue resistance is met, force will be applied cautiously.

b. The rifle will not be disassembled or assembled against time. Instruction, blindfolded, may be given to men who have passed their tests in mechanical training. In all work in disassembling the rifle, the men will be taught to lay out the parts on a smooth, clean surface from left to right, in the same sequence as they are disassembled from the rifle. The trigger mechanism will not be disassembled or assembled blindfolded.

■ 7. NOMENCLATURE.—The names of the parts to which reference is made in mechanical training are readily learned as this training progresses. Instructors will therefore take care to name the parts clearly and correctly in their work. A sufficient knowledge of the nomenclature of the rifle is

gained by the soldier during the instruction in mechanical training.

■ **8. DISASSEMBLING.**—*a. General.*—Authorized disassembly by the soldier is limited to that required for proper care and maintenance of the rifle. Further disassembly will be done under the supervision of an officer or ordnance personnel. The individual soldier is prohibited from disassembling the—

- (1) Forearm group.
- (2) Barrel group.
- (3) Butt stock and buffer group.
- (4) Rear sight group.
- (5) Receiver group.

b. Sequence.—The steps in the disassembly of the rifle authorized to be performed by the individual soldier without supervision are performed in the following sequence:

- (1) *Operating group.*—(a) Cock the rifle and remove—
 1. Gas cylinder tube retaining pin and spring.
 2. Gas cylinder tube and forearm.
- (b) Let the slide forward and remove—
 1. Trigger guard retaining pin and spring.
 2. Trigger guard.
 3. Recoil spring guide.
 4. Recoil spring.
 5. Operating handle.
 6. Hammer pin.
 7. Hammer.
 8. Slide.
 9. Bolt assembly.
 10. Firing pin.
 11. Bolt link pin.
 12. Bolt link.
 13. Extractor.
 14. Extractor spring.
- (2) *Trigger group.*—Remove—
 - (a) Ejector.
 - (b) Magazine catch spring.
 - (c) Magazine catch pin.
 - (d) Magazine catch.

- (e) Magazine release.
- (f) Sear spring.
- (g) Trigger pin.
- (h) Trigger.
- (i) Connector.
- (j) Sear pin.
- (k) Sear.
- (l) Sear release stop lever.
- (m) Sear carrier.
- (n) Counterrecoil spring.
- (o) Change lever.
- (p) Change lever spring.
- (3) *Bipod group*.—Remove—
 - (a) Flash hider.
 - (b) Two bipod leg clamp wing screws.
 - (c) Right and left bipod leg assemblies.
 - (d) Two bipod clamp leg guides.
 - (e) Two bipod body wing screws.
 - (f) Right and left bipod leg tubes.
 - (g) Bipod spring-lock washer.

c. *Method*.—The following detailed explanation of the method of disassembling the automatic rifle is furnished as an aid to instructors:

(1) *Operating group* (figs. 1 and 2).—Lay rifle on a table, barrel down, pointing to the left. Cock the rifle. Turn gas cylinder tube retaining pin spring (1) 180° in a clockwise direction and pull out gas cylinder tube retaining pin and spring (1). Remove gas cylinder tube and forearm (2). Let slide (10) forward *easily* by pressing trigger with thumb of the right hand and at the same time grasping the slide with the left hand so that the middle and index fingers are astride the gas piston. Turn trigger guard retaining pin spring (3) 90° in a clockwise direction and pull out the pin and spring (3). Lift out trigger group (4). Remove recoil spring guide (5) by pressing right index finger on checkered surface of its head and turning it until ends are clear of the retaining shoulders. Remove recoil spring (6). Line up hammer pin holes in receiver and operating handle by inserting point of recoil spring guide in hole in operating handle with right hand, press against hammer pin (8) until it clears the

operating handle by jutting through its hole in the receiver as the operating handle is pushed slowly to the rear with the left hand. Remove operating handle (7) by pulling straight to the rear. Remove hammer pin (8). Push hammer (9) forward out of its seat in the slide (10) and lift out of the receiver. Push the bolt link (13) to the rear and down. Being careful to avoid striking the gas piston or rings against the gas cylinder tube bracket, remove slide (10) by pulling it forward out of the receiver. Pry bolt guide (17) outward with the rim of a cartridge. Lift out bolt assembly (14) by pulling it slowly to the rear end of the receiver and raising it with the right thumb and forefinger. (As an alternate method of removing the bolt, move bolt assembly all the way to the rear end of receiver, bolt link up and forward. Then, grasp front end of bolt between left forefinger and thumb, rotate bolt assembly gently to clear bolt guide and bolt support on sides of receiver, and lift bolt assembly out of receiver.) Pull out firing pin (11) from its aperture in the bolt. Remove bolt link pin (12). Remove bolt link (13). Remove extractor (15) by pressing the point of a dummy cartridge against claw and exerting pressure outward and to the front. Remove extractor spring (16).

(2) *Trigger group* (fig. 3).—(a) Depress ejector lock with the point of a dummy cartridge. Hold thumb in front of magazine catch spring to prevent it from flying out, and then slide ejector (18) out of its seat. Remove magazine catch spring (19). Remove magazine catch pin (20), lift out magazine catch (21) and magazine release (22).

(b) Holding trigger guard so that its rear is away from the body, insert trigger guard retaining pin spring under the *three leaves* of the sear spring *above the connector stop*. Pry up so that center leaf trips above front end of sear. Rotating the trigger guard retaining pin forward while pressing firmly down and forward on sear spring with the left thumb, unseat the sear spring and pull it out to the front. Remove the trigger pin (24). The trigger pin must always be removed before the sear pin in order that tension of the counterrecoil spring will always be on the sear pin. Remove trigger (25) and connector (26) through top of the trigger guard. Push out sear pin (27) with the recoil

spring guide. Remove sear (28) and sear release stop lever (29). Noting the manner in which these parts are fitted together prior to separating them, separate the sear and sear release stop lever. Pry up on the sear carrier (30) by

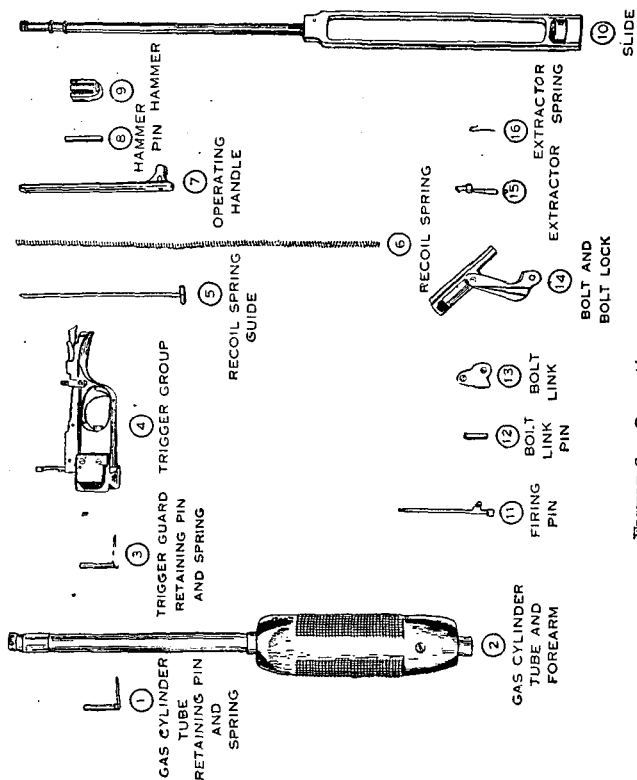

FIGURE 2.—Operating group.

inserting the point of the recoil spring guide in either of the sear pin holes in the sear carrier. Lift out the sear carrier and counterrecoil spring (31). Remove the change lever (32) by prying up on the forward end of the change lever spring with the rounded end of the sear spring held in the

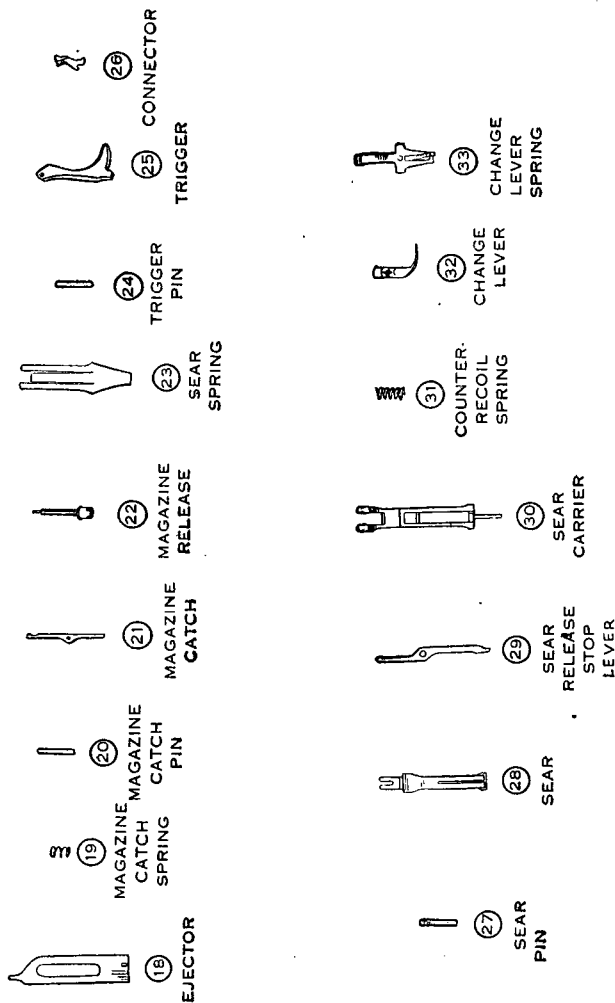

FIGURE 3.—Trigger group.

right hand, withdrawing the change lever to the left with the left hand. Being careful not to bend or break the sear release stop lever spring which is riveted to the change lever spring (33), remove the change lever spring by prying it to the rear with the rounded end of the sear spring so as to unseat the shoulders of the change lever spring from their slots in the trigger guard.

(3) *Bipod group* (fig. 4).—The disassembling of the bipod group generally is not performed as a part of mechanical training. However, it may become necessary to disassemble this group to replace damaged or broken parts, and the following procedure is prescribed: Unscrew the flash hider (34). Remove the bipod assembly. Unscrew the two bipod leg clamp wing screws (35). Remove right and left bipod legs (36). Remove the two bipod clamp leg guides (37). Unscrew the two bipod body wing screws (38). Remove right and left bipod leg tubes (39) from bipod body (40). Remove bipod spring-lock washer (41).

■ 9. ASSEMBLING.—The rifle and its component parts are assembled in the reverse order of their disassembly as given in paragraph 8c. The following detailed explanation of the method of assembling the rifle is furnished as an aid to instructors:

a. *Bipod group* (fig. 4).—Replace bipod spring-lock washer (41). Replace the right and left bipod leg tubes (39) on the bipod body (40). Screw the two bipod wing screws (38) into the bipod body. Replace the two bipod clamp leg guides (37) in their slots on the right and left bipod legs. Replace bipod legs (36) in the bipod leg tubes (39). Aline U-shaped opening of the bipod clamp leg guides with the holes in the bipod leg clamps, and replace the bipod leg clamp wing screws (35). Replace bipod assembly on the rifle. Screw flash hider (34) on to the rifle.

b. *Trigger group* (fig. 3).—(1) Replace the change lever spring (33) with sear release stop lever spring up and to the rear, by pressing down and forward on the rivet with the thumb of the right hand and engaging the ears of the change lever spring in their slots in the rear of the trigger guard. Then, *being careful not to bend or break the sear re-*

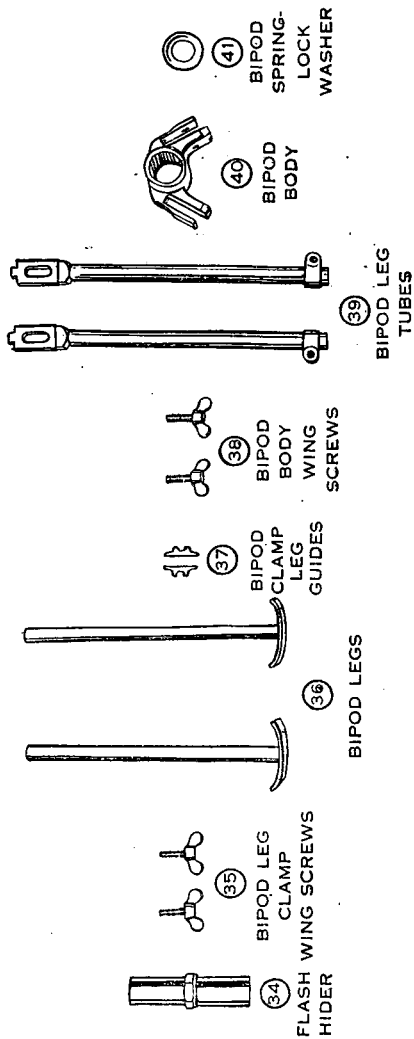

FIGURE 4.—Bipod group.

lease stop lever spring, continue the pressure with the right thumb, using rounded end of the sear spring as a ramp, and seat the rear end of the change lever spring in its slot. Replace change lever (32) by inserting it in its hole in the trigger guard with the left hand while with the right hand prying up on the forward end of the change lever spring with the rounded end of the sear spring. Replace counterrecoil spring (31) on counterrecoil spring guide (front end of sear carrier). Insert counterrecoil spring guide into its seat in the trigger guard. Brace forward end of trigger guard against an immovable object, and with the thumbs pressing on the rear of the sear carrier, push sear carrier (30) forward until its rear end is held by the ears of the change lever spring. Replace the sear release stop lever (29) in its proper seat in the sear (28) by holding the sear in the left hand with the thumb and forefinger at the holes, sear nose up and to the rear; then, taking the long end of the sear release stop lever in the right hand, short end up and to the front, inserting its short end upward through the slot in the forward part of the sear and alining the holes. Replace sear and sear release stop lever on sear carrier with sear nose up and to the rear. Replace sear pin (27) by alining the holes in the sear release stop lever, sear, sear carrier, and trigger guard with the recoil spring guide and inserting the sear pin as the recoil spring guide is slowly worked out (considerable pressure must be exerted by means of the recoil spring guide in order to overcome the resistance of the strong counterrecoil spring). The sear pin must be replaced before the trigger pin in order that tension of the counterrecoil spring will always be on the sear pin.

(2) Replace connector (26) in the trigger (25) by holding the trigger in the left hand with the thumb and forefinger at the hole and the toe of the trigger in the palm of the hand. Pick up the connector in the right hand, toe to the rear and down, and place it in its seat in the trigger. Place the trigger and connector in the trigger guard by holding the trigger guard in the palm of the right hand with the sear carrier up, forward end of trigger guard tipped downward at about a 45° angle, and placing the trigger and connector down through the sear carrier until the connector passes un-

der and to the rear of the connector stop. Replace trigger pin (24). Place the two outer leaves of the sear spring on top of the forward shoulders of the sear and the middle leaf under the forward end of the sear release stop lever, depress the rear end of the sear and slide the sear spring to the rear until its shoulders are in the rear of the slots in the trigger guard, press down and forward on the sear spring with the thumb of the right hand until the front end of the sear spring (23) rests in the depression stop.

(3) Replace magazine release (22). Replace magazine catch (21), spring depression facing out. Replace magazine catch pin (20). Replace magazine catch spring (19). Insert ejector (18) into recess and move it down until it is flush with the magazine catch spring. Compress magazine catch spring in its seat and move ejector down until it is flush with the ejector lock. Depress the ejector lock with the base of a dummy cartridge and push ejector home until the ejector lock is in its proper position.

(4) After trigger mechanism has been assembled, turn change lever to forward position, and pull trigger. If connector will not rise, it is not in place correctly. It should rise and snap out from under sear. If connector will rise but does not raise sear, the middle leaf of the sear spring is weak and the sear spring should be replaced.

c. Operating group (figs. 1 and 2).—Replace extractor spring (16) in the extractor with the short end in the hole and the long end along the groove in the side. Place extractor (15) in its seat in the bolt. Replace bolt link (13) in the bolt lock with the shoulder of the link against the flat surface of the bolt lock. Replace bolt link pin (12). Lift bolt lock and insert the firing pin (11) in its receptacle in the bolt. Lay rifle barrel down and pointing to the left so that rifle is resting on the front sight cover and rear sight base. With bolt (14) and its assembly held in a perpendicular position, insert it in the receiver between the bolt guide and the rear ends of the bolt supports. Press the assembled bolt down so it will lie flat in its place. With bolt link down, push bolt forward. Replace slide (10) with the sear notch up, and push it back all the way. With hammer (9) held with the thumb and forefinger of the left

hand, place it in its seat in the slide, rounded end to the rear. Push bolt lock fully into its locking recess and push slide forward. Using the recoil spring guide as a drift, align the hammer pin holes of the bolt link, hammer, and slide with the hammer pin holes in the sides of the receiver. Insert hammer pin (8) to the right, allowing about $\frac{1}{4}$ inch of the hammer pin to protrude from the receiver. Replace operating handle (7). Push protruding hammer pin all the way home. Replace recoil spring (6). Insert recoil spring guide (5) in the recoil spring, and, with the end of the index finger on the checkered end of the recoil spring guide, turn it until it is properly seated. Replace trigger group (4). Replace trigger guard retaining pin and spring (3). Cock the rifle. Slide gas cylinder tube and forearm (2) to the rear over the gas piston until its rear end is seated in the slot in the front end of the receiver. Replace the gas cylinder tube retaining pin and spring (1). Test rifle by pulling the trigger.

■ 10. TO REMOVE FIRING PIN WITHOUT DISASSEMBLING (fig. 5).—To remove firing pin without disassembling the rifle, lay rifle upside down on table, muzzle to the front. Remove the trigger group. Place rim of cartridge under *center* of bolt guide. With the right hand, slowly pull the operating handle all the way to the rear, taking care not to dislodge the rim of the cartridge from beneath the bolt guide. With the left hand, palm up, grasp the stock so that at least two fingers of the left hand are on the operating handle, holding it to the rear, while the thumb of the left hand is on the bolt link in the rear of the receiver (fig. 5 ①). Release the operating handle with the right hand, it still being held in the rearmost position by the fingers of the left hand. Pry the bolt guide outward with the right hand by placing the middle finger of the right hand under the base of the cartridge while the thumb exerts pressure on the nose (fig. 5 ②). Press down on the bolt link with the thumb of the left hand, causing the bolt to break at the bolt lock pin (fig. 5 ③). Allow bolt to go forward until it stops. Change firing pin. Pull operating handle to the rear again and push bolt into position.

■ 11. TO REMOVE AND REPLACE EXTRACTOR WITHOUT DISASSEMBLING.—*a. Removal* (fig. 6).—Pull operating handle toward the rear and insert an *empty* cartridge case, base to

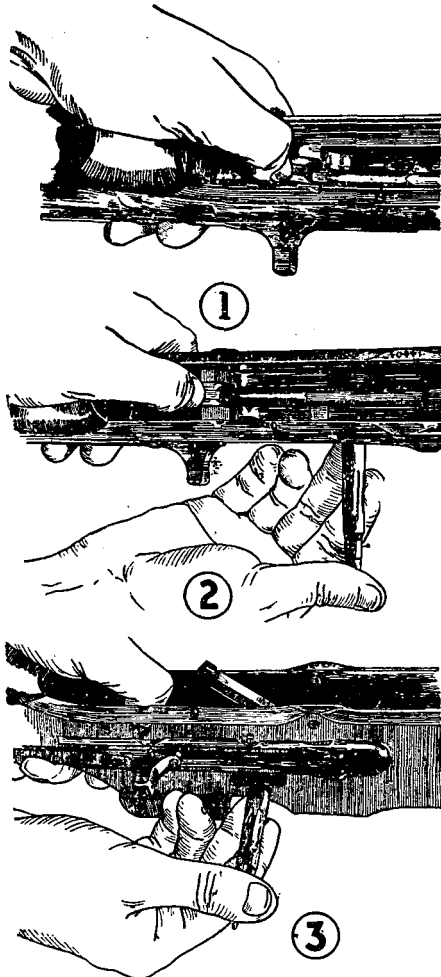

FIGURE 5.—Removing firing pin without disassembling.

the front, between the bolt and chamber, exposing the extractor in the ejection opening (fig. 6 ①). Lay rifle on its side so that the ejection opening is up. With forefinger of

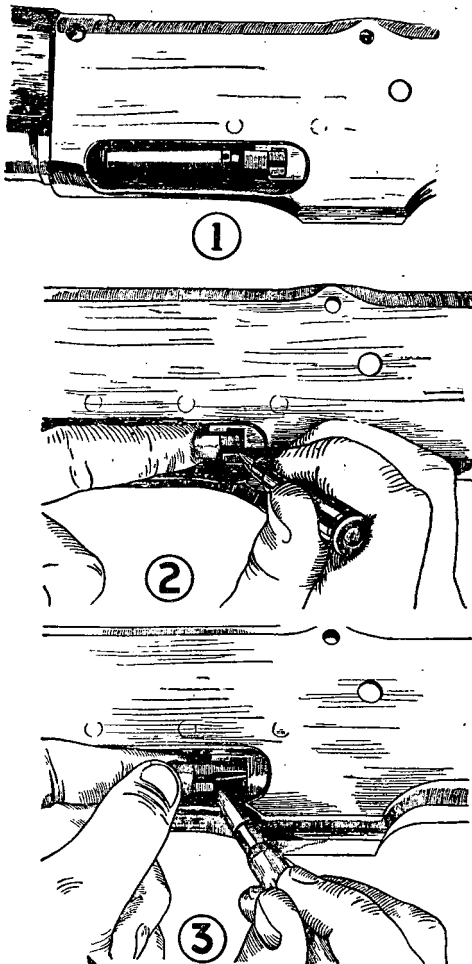

FIGURE 6.—Removing extractor without disassembling.

the left hand, pull out claw of the extractor, then place nose of a cartridge behind the extractor shoulder (fig. 6 ②) and pry it forward until extractor is free of the recess (fig. 6 ③). Remove extractor and extractor spring.

b. Replacement.—Insert short end of extractor spring in the hole in the shank of the extractor so that the long end on the spring is along the slot in the extractor. Insert extractor and spring in the end of the bolt and push them into position. Remove empty cartridge case.

■ 12. **DISASSEMBLING AND ASSEMBLING MAGAZINE** (fig. 7).—Raise rear end of magazine base until indentations are clear, then slide it to the rear. The magazine spring and follower will then fall out. It is assembled in the reverse order.

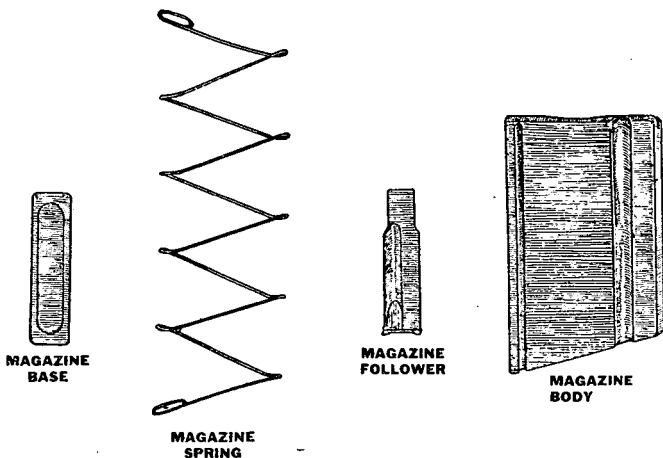

FIGURE 7.—Magazine.

SECTION III

CARE AND CLEANING

■ 13. **GENERAL.**—*a. Importance.*—Care and cleaning includes the care of the automatic rifle necessary to preserve its condition and appearance under all conditions at all times. Unserviceable rifles are usually the result of improper care

and cleaning. Rifles in the hands of troops should be inspected daily to insure proper condition and cleanliness.

b. Lubricants, cleaning materials, and rust preventives.—The following are the only materials authorized and issued for the care and cleaning of the Browning automatic rifle. The use of unauthorized materials such as abrasives is prohibited.

(1) *Cleaner, rifle bore.*—(a) Rifle bore cleaner is issued for cleaning the bore of the rifle after firing. It possesses rust-preventive properties and provides temporary protection against rust. It is preferable, however, to dry the bore immediately after cleaning and oil it lightly with light preservative lubricating oil.

(b) Rifle bore cleaner will freeze at temperatures below 32° F. Therefore, closed containers should not be filled more than three-fourths full in freezing weather as full containers, when frozen, will burst. Once frozen and thawed out, it must be shaken well before using.

(2) *Oil, light preservative, lubricating.*—This oil is used for lubrication of all moving parts and is also effective as a rust-preventive for short term storage of the automatic rifle. Depending on climatic conditions, it is effective for periods of 2 to 6 weeks. However, rifles in short-term storage must be inspected every 4 or 5 days to renew the preservative film, if necessary. For longer periods of storage, the rifles will be protected with light rust-preventive compound.

(3) *Oil, lubricating, for aircraft instruments and machine guns.*—This oil may be used for lubricating the rifles when light preservative oil is not available or in temperatures below 32° F. It is an extremely light oil which relies entirely upon maintenance of a film to protect metal surfaces from rusting. When used as a preservative, the metal parts must be inspected daily for rust, cleaned, and again lightly coated with the oil.

(4) *Oil, engine, SAE 10 or other light machine oil.*—Any good, light oil may be used when oils previously mentioned can not be obtained. However, in cold weather any of the heavier oils will cause sluggish operation or rifles may not work at all. Alternate oils do not possess the rust-preventive

properties of preservative lubricating oil, and when used, matériel should be examined, cleaned, and recoiled frequently.

(5) *Compound, light rust-preventive.*—This compound is issued for protecting metal parts for long periods of time while rifles are boxed and in storage. It should be warmed before application. However, when heating facilities are not available, it can be effectively brushed onto the parts, provided the temperature is above 80° F. Below 80° F., light rust-preventive compound becomes sluggish and its use without preheating is uneconomical.

(6) *Solvent, dry-cleaning.*—This is a petroleum distillate and therefore inflammable. Smoking is prohibited where it is employed. Dry-cleaning solvent is used for removing grease, oil, or rust-preventive compound. Metal surfaces are bathed in the solvent with rag swabs. After bathing, the solvent must be thoroughly wiped off all metal surfaces with clean rags. After cleaning with solvent, metal parts are especially susceptible to corrosion from finger marks. Finger marks must be wiped off. Cleaning solvent will attack and discolor rubber.

(7) *Soap and water.*—If rifle bore cleaner is not available, water will be used; warm water is good, but warm, soapy water is better. It is used to clean the bore and gas system.

(8) *Soda ash.*—Soda ash, a commercial sodium carbonate, may be used in water in lieu of soap.

(9) *Oil, linseed.*—Raw linseed oil is applied to the woodwork of the rifle at intervals to preserve the wood and to keep out moisture.

(10) *Oil, neat's-foot.*—This oil is used for cleaning and softening the sling. It should be used sparingly, rubbed in, and wiped off carefully to prevent soiling clothing.

■ 14. CARE AND CLEANING.—*a. General.*—(1) Automatic rifles and magazines in the hands of troops and in temporary storage within the unit must receive daily attention.

(2) Automatic rifles will be disassembled only to the extent necessary for proper cleaning. Whenever necessary, magazines will be disassembled for cleaning and light lubrication.

(3) Proper oiling is second in importance only to intelligent cleaning. It is a vital necessity for the working parts,

but the oil should be used sparingly; wiping with a well-oiled rag is the best method.

b. When no firing is being done.—Care and cleaning of the automatic rifle and magazines when no firing is being done will include the care necessary to preserve their condition and appearance.

(1) To clean the bore of the automatic rifle, pass a dry patch through the bore by inserting the cleaning rod through the muzzle end. Repeat with dry patches, unless the bore is unduly dry in which case an oily patch will be used to loosen the dry film, until several successive patches have come out clean. Push a patch dampened with oil through the bore to protect its surface. Dust out all screw heads and crevices with a small cleaning brush or wood splinter. Wipe all metal surfaces with a dry cloth to remove moisture, perspiration, and dirt. Wipe the outer surfaces of the automatic rifle, including the forearm, with a lightly oiled cloth (see par. 13*b* for proper lubricants). This protective film on all metal parts will be maintained at all times. At least once a month, and always after the stock and forearm have become wet, they should be rubbed thoroughly with a little linseed oil in the palm of the hand. Rub oil in until dry. Use neat's-foot oil moderately for cleaning and softening the sling.

(2) It is imperative that magazines be given the best of care and kept in perfect condition. They must be kept free from dirt and rust and handled so as to avoid any dents or abrasions. To clean, they should be disassembled when necessary, wiped clean and dry, and thinly coated with oil.

c. After firing.—(1) The bore of the rifle will be thoroughly cleaned by the evening of the day on which it is fired and similarly cleaned for the next three days.

(2) Disassemble the rifle. The bore is cleaned by swabbing with a patch saturated with rifle bore cleaner. Repeat with several patches. If rifle bore cleaner is not available, water will be used. The water should be soapy and preferably warm. Soda ash may be used in lieu of soap. While swabbing the bore with water, rest the rifle on the toe of the butt, muzzle elevated slightly so that the water drips out of the receiver and does not get into the buffer, rate-reducing mechan-

THE ARMY LIBRARY

ism, and the locking recess. While the bore is still wet, run the metal brush through it several times. Remove the brush and swab the bore again with a patch saturated with cleaner or with water. Follow this with dry patches until several patches come out clean and dry. When it is clean, push a patch dampened with oil through the bore to protect its surface.

(3) Clean the chamber with the chamber cleaning brush, wipe clean with a cloth, and oil lightly.

(4) To clean the gas system, remove the gas cylinder from the gas cylinder tube. Insert the smooth end of the body of the gas cylinder cleaning tool into the gas cylinder. Turn it to the right while gradually scraping into the cylinder head. As it reaches the head, apply additional pressure to the tool and give it a few turns to cut the carbon from the bottom inside surface. Withdraw and reverse the tool. Using the recess cutter as a gage, remove the carbon from the recesses at the forward end of the interior of the gas cylinder. With the drift point, clean the gas ports in the barrel, gas cylinder tube, and gas cylinder. Scrape the carbon from the face of the piston with the front cutting edge of the tool body, and remove the deposit from between the piston rings with the drift point. Wipe thoroughly with a rag saturated with rifle bore cleaner, if available. Otherwise, wash with hot water and soap or soda ash solution (if not available, use plain water) and dry thoroughly. Inspect for cleanliness. When it is clean, oil lightly. Clean the gas cylinder tube by washing with hot water and soap or soda ash solution (if unavailable, use plain hot or cold water). This cleaning may be facilitated by tying a cloth tightly into the center part of a string or thong and pulling it back and forth inside the tube. Dry thoroughly and *inspect*. When clean, oil lightly.

(5) Wipe the remaining parts of the operating group dry and clean; apply a thin film of oil.

(6) Wipe the trigger group dry, disassembling it only periodically or when necessary, and oil lightly.

(7) Wipe the outer metal parts of the rifle dry and apply a thin film of oil.

(8) Clean the stock and forearm of the rifle and wipe the sling with a clean, dry cloth.

(9) Inspect the interior of the magazines by depressing the follower with the thumb. If the interior is dirty, disassemble, clean thoroughly, and oil lightly. Otherwise, merely wipe clean and dry, and oil. Much magazine trouble can be avoided by proper handling to avoid dirt and dents. It is imperative that magazines be given proper care and handling.

d. Points to be observed before, during, and after firing.—See paragraph 40.

■ 15. STORAGE.—For preserving and lubricating materials, see paragraph 13b.

a. Preparation for storage.—Automatic rifles should be cleaned and prepared for storage with particular care. The bore, all parts of the mechanism, and the exterior of the rifles should be thoroughly cleaned and then completely dried with rags. In damp climates, particular care must be taken to see that the rags are dry. After drying a metal part, the bare hands should not touch that part. Special care should be taken to insure that the gas system is thoroughly cleaned and that the gas ports are free from fouling. All metal parts should then be coated with either light preservative lubricating oil, or light rust-preventive compound, depending on the length of storage required. Before placing the automatic rifle in the packing chest, the wooden supports for the butt and muzzle will be painted with rust-preventive compound. Under no circumstances will a rifle be placed in storage while in a cloth or other cover, or with a plug in the bore. Such articles collect moisture which causes the weapon to rust.

b. Cleaning when received from long-term storage.—Automatic rifles which have been stored in accordance with *a* above will be coated with either light preservative lubricating oil or with rust-preventive compound. Weapons received from ordnance storage will in general be coated with rust-preventive compound. Use dry-cleaning solvent to remove all traces of the compound or oil, particular care being taken that the gas system, gas ports, firing pin, and all recesses in which springs or plungers operate are cleaned thoroughly.

After using the cleaning solvent, make sure it is completely removed from all parts by wiping with a dry cloth.

NOTE.—Failure to clean the gas system, the firing pin, and the recesses of the bolt in which it operates may result in gun failure at normal temperatures and will certainly result in serious malfunctions if the rifle is operated in low temperature areas, as rust-preventive compound and other foreign matter will cause the lubricating oil to congeal on the mechanism.

■ 16. CARE AND CLEANING UNDER UNUSUAL CONDITIONS.—*a. In cold climates.*—(1) For temperatures below freezing, it is necessary that the moving parts of the weapon be kept absolutely free from moisture. It has also been found that excess oil on the working parts will solidify to such an extent as to cause sluggish operation or complete failure. Oil must be applied *very* sparingly by wiping with a cloth which has first been wet with light preservative lubricating oil and then wrung out.

(2) The metal parts of the weapon should be taken apart and completely cleaned with dry-cleaning solvent or equivalent before use in temperatures below 0° F. The working surfaces of parts which show signs of wear may be lubricated by rubbing with a cloth slightly dampened with light preservative lubricating oil as prescribed in (1) above. At temperatures above 0° F., all metal surfaces of the weapon may be oiled lightly after cleaning, by wiping with a slightly oiled cloth, using light preservative lubricating oil.

(3) When it is brought indoors, the weapon should first be allowed to come to room temperature. It should then be disassembled, wiped completely dry of the moisture which will have condensed on the cold metal surfaces, and thoroughly oiled with light preservative lubricating oil. This will be done every time a weapon is carried into a warm room after exposure to low temperature. If possible, such condensation should be avoided by providing a cold place in which to keep rifles when not in use. For example, a separate cold room with appropriate racks may be used, or in the field, racks under proper cover may be set up outdoors.

(4) If the weapon has been fired, it should be thoroughly cleaned and oiled. The bore may be swabbed out with an oily patch and when the weapon reaches room temperature, thoroughly cleaned and oiled as prescribed in paragraph 14c.

(5) Before firing, the weapon should be cleaned and oil removed as prescribed in (2) above. The bore and chamber should be entirely free of oil before firing. In cold climates, the medium gas port will usually be found to be the most satisfactory initial setting of the gas cylinder.

b. In hot climates.—(1) *Tropical climates.*—(a) Light preservative lubricating oil should be used for lubrication.

(b) In tropical climates where temperatures and humidity are high, or where salt air is present, and during rainy seasons, the weapon should be thoroughly inspected daily and kept lightly oiled when not in use. The groups should be dismantled at regular intervals and, if necessary, disassembled sufficiently to permit the drying and oiling of parts.

(c) Care should be exercised to see that unexposed parts and surfaces are kept clean and oiled.

(d) Wood parts should also be inspected to see that swelling due to moisture does not bind working parts. (In such cases shave off only enough wood to relieve binding.) A light coat of raw linseed oil applied at intervals and well rubbed in with the heel of the hand will help to keep moisture out. Allow oil to soak in for a few hours and then wipe and polish wood with a dry clean rag.

NOTE.—Care should be taken that linseed oil does not get into mechanism or on metal parts as it will gum up when dry.

(2) *Hot, dry climates.*—(a) In hot, dry climates where sand and dust are likely to get into the mechanism and bore, the weapon should be wiped clean daily or oftener if necessary. Groups should be dismantled and disassembled as far as necessary to facilitate thorough cleaning.

(b) When the weapon is being used under sandy conditions, the weapon should be wiped completely dry of all lubricant. This will prevent sand carried by the wind from sticking to the lubricant and forming an abrasive compound which will ruin the mechanism. Immediately upon leaving sandy terrain, the weapon must be relubricated with light preservative lubricating oil.

(c) In such climates, wood parts are apt to dry out and shrink, and a *light* application of linseed oil, applied as in (1) (d) above, will help to keep wood in condition.

(d) Perspiration from the hands is a contributing factor

to rust because it contains acid, and metal parts should be wiped dry frequently.

(e) During sand or dust storms, the breech and muzzle should be kept covered.

c. Care when subject to gas attack.—(1) It is important to prevent chemicals used in a gas attack from coming into contact with the automatic rifle, ammunition, and accessories. When a gas attack is anticipated, the following action will be taken: apply oil to all outer metal surfaces of the automatic rifle and accessories. If it is not to be used, cover rifle, accessories, and ammunition. *Do not apply oil to ammunition.*

(2) After the attack, determine by means of detector crayon or paper whether or not the matériel is contaminated (par. 127, FM 21-40). If uncontaminated, clean matériel with dry-cleaning solvent. Prepare for use as required.

(3) If contaminated, the following action will be taken:

(a) A suit of protective clothing (permeable or impermeable) and a service gas mask must be worn for decontamination.

(b) Matériel contaminated with chemicals other than mustard or lewisite must be cleaned as soon as possible with dry-cleaning solvent or denatured alcohol.

(c) Do not allow the chemical agent to come into contact with the skin. Burn, or *preferably bury*, all rags or wiping materials used for decontamination. *Extreme caution should be taken to protect men against fumes created by burning.*

(d) If the surface of the matériel is coated with grease or oil and has been in a mustard or lewisite attack, first remove the grease or oil by wiping with rags wet with dry-cleaning solvent.

(e) Decontaminate the rifle with a solution of agent, decontaminating, noncorrosive (par. 132, FM 21-40). Prepare this by mixing one part of agent, decontaminating, noncorrosive, to 15 parts of solvent (acetylene tetrachloride) by weight, or by mixing one part of decontaminating agent, noncorrosive, with six parts of solvent by volume.

(f) After decontamination, clean the matériel thoroughly and prepare for use as required.

(g) Detailed information on decontamination is contained in FM 21-40, TM 9-850, and TM 3-220.

SECTION IV

FUNCTIONING

■ 17. GENERAL.—*a. Object.*—This section is designed to provide a nontechnical description of the functioning of the rifle. The object of instruction in this subject is to lead the soldier to an understanding of the simple functioning of his weapon without emphasis on memorizing the matter of the text.

b. When taken up.—Instruction in functioning will be taken up after instruction in the disassembly, assembly, care and cleaning of the rifle.

■ 18. USE OF DUMMY CARTRIDGES.—The corrugated type of dummy cartridge (cal. .30, M1906) may be used for instruction in functioning. The use of the slotted type of dummy cartridge (range, cal. .30, M1) is prohibited. Special care must be exercised in the use of dummy cartridges that they do not introduce dirt or grit into the chamber of the rifle.

■ 19. MECHANICAL MEANS OF FUNCTIONING.—All automatic weapons must have mechanical means for performing the following functions: extraction, ejection, feeding, locking the breech while there is a high pressure in the bore, and igniting the cartridge. Operations such as extraction and ejection are performed by various cams, lugs, and springs, and the energy necessary to perform this work and to overcome friction in the rifle is derived from the explosion of the powder in the chamber.

■ 20. CYCLE.—*a.* One rearward and one forward movement of the mechanism is a cycle. This begins with the ignition of the cartridge in the chamber and ends at the ignition of the succeeding cartridge. The functioning of the automatic rifle is divided into two phases based on the operation of the mechanism in one cycle. These two phases are the rearward movement and the forward movement. The striking of the buffer by the slide marks the division of the two phases.

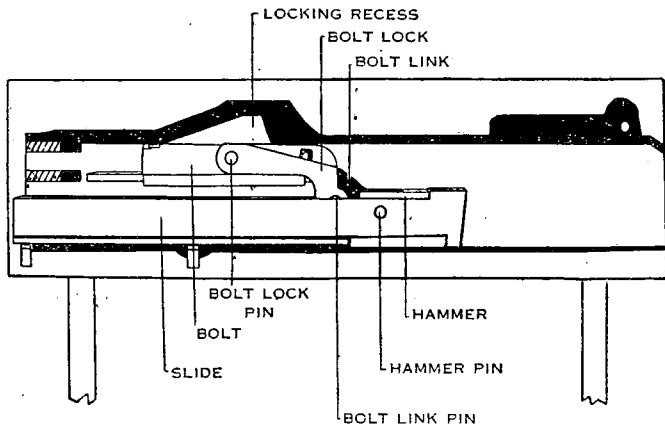

FIGURE 8.—Wooden working model showing bolt action.

b. The operations which take place in the rearward movement are—

- (1) Action of gas.
- (2) Movement of slide to rear.
- (3) Unlocking.
- (4) Withdrawal of firing pin.
- (5) Extraction.
- (6) Ejection.
- (7) Termination of first phase.

c. The operations which take place in the forward movement are—

- (1) Action of recoil spring.
- (2) Feeding.
- (3) Locking.
- (4) Ignition.
- (5) Termination of second phase.

■ 21. DESCRIPTION OF CYCLE.—*a. Rearward movement.*—(1) *Action of gas.*—A cartridge having been ignited, the bullet, under the pressure of the expanding powder gases, travels through the barrel, and when it reaches a point 6 inches from the muzzle it passes a port in the bottom of the barrel. The barrel pressure, which at this instant is still very high, seeks

this first natural vent. Aligned with the barrel port are other similar ports in the gas cylinder tube bracket, gas cylinder tube, and gas cylinder. The port in the gas cylinder is the smallest and serves to throttle the barrel pressure. The port in the gas cylinder leads radially into a well about $\frac{1}{8}$ inch in diameter in the head of the gas cylinder. The throttled barrel pressure is conducted through this well to the gas piston plug. This pressure acts on the piston for the very short time which it takes for the bullet to travel the 6 inches of distance from the barrel port to the muzzle. Its effect is that of a sudden severe blow on the piston plug. Under the impact of this blow, the gas piston is driven to the

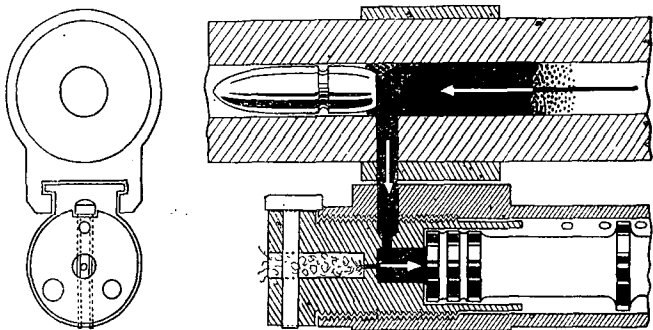

FIGURE 9.—Action of gas.

rear carrying the slide with it. When the piston has traveled about $\frac{9}{16}$ inch backward, the bearing rings on its head and the gas piston plug pass out of the cylinder. The gas expands around the piston head and into the gas cylinder tube and is exhausted through the six portholes in the tube. The gas is prevented from traveling back through the gas cylinder tube by the two rings on the piston, about $\frac{5}{8}$ inch apart and $1\frac{1}{4}$ inches from the piston head. These rings also serve as bearings to hold the front end of the piston in the center of the gas cylinder tube after the piston head has passed out of the gas cylinder.

(2) *The slide.*—As the piston is forced back, it carries the slide with it. The first and the immediate result of the back-

ward movement of the slide is to begin the compression of the recoil spring, thereby storing energy for the forward action. The hammer pin is slightly in advance of the bolt link pin, about 0.19 inch. The center rib of the hammer is very slightly in rear of the head of the firing pin. When the slide begins its motion to the rear, it imparts no motion whatever to the bolt and bolt lock. The slide moves back 0.19 inch, and its only effect during this travel is to carry the hammer from the firing pin and the hammer pin directly under the bolt link pin.

(3) *Unlocking.*—At this point the unlocking begins. The bolt link revolves forward about the hammer pin, drawing the bolt lock down and to the rear. The motion of the lock and bolt, which is zero at the instant the hammer pin passes under the bolt link pin, accelerates from this point until the slide has traveled about 1.2 inches, at which latter point the bolt lock is drawn completely down out of the locking recess and away from the locking shoulder of the receiver. It is now supported in front on the bolt supports. The front upper surface of the bolt link has revolved forward and bears upon the locking surface of the bolt lock. These two influences prevent the bolt lock from revolving down below the line of backward travel of the bolt.

(4) *Withdrawal of firing pin.*—As the bolt lock revolves down from its locked position, a cam surface in a slot in the rear bottom side of the bolt lock comes in contact with a similar cam surface on the firing pin lug. This action cams the firing pin from the face of the bolt.

(5) *Extraction.*—The backward motion of the bolt begins when the bolt lock has been drawn down so that the circular cam surface on its under side is operating on the rear shoulders of the bolt supports. This produces a strong lever action which slowly loosens the cartridge case. The backward travel of the bolt has been slight, only about $\frac{5}{32}$ inch when the firing pin is withdrawn; its travel is about $\frac{11}{32}$ inch when the bolt lock is completely drawn down. From this point the bolt moves to the rear, drawn by the bolt lock and bolt link, with the same speed as the slide and carries with it the empty cartridge case which is held firmly in its seat on the face of the bolt by the extractor. The extractor is on the

upper right side of the bolt next to the ejection opening in the receiver. A slot cut in the left side of the bolt lock near the back end passes over the bolt guide, which supports the bolt lock and bolt when they are in the rear position.

(6) *Ejection.*—When the slide reaches a point about $\frac{1}{4}$ inch from the end of its travel, the base of the cartridge case strikes the ejector. This action causes the cartridge case to be pivoted with considerable force about the extractor and through the ejection opening in the receiver. The front end of the cartridge case passes first out of the receiver and is pivoted so that it strikes the outside of the receiver at a point about .1 inch in rear of the ejection opening. It rebounds from the receiver toward the right front.

(7) *Termination of rearward movement.*—The rearward motion terminates when the rear end of the slide strikes the buffer head and sear release. The slide, under the action of the recoil spring, moves forward $\frac{1}{10}$ inch after striking the buffer head and sear release. If the sear nose is not depressed, it engages the sear notch on the slide and the piece is cocked for the next burst or shot.

NOTE.—The motion of the bolt, bolt lock, and bolt link mechanism begins slowly at first and does not attain the speed of the slide until the latter has traveled about $1\frac{1}{4}$ inches backward. This is a very important characteristic of the rifle, since on this account the mechanism is not subjected to an excess strain due to a sudden start at the instant the gas strikes the piston. This slow start also allows the bullet to clear the muzzle thereby preventing a blow-back of the expanding gases.

b. Forward movement.—(1) *Action of recoil spring.*—When the trigger is pressed, the sear nose is depressed, disengaging the sear, and the slide moves forward under the action of the recoil spring. The position of the bolt link pin is slightly below a line joining the bolt lock pin and the hammer pin; therefore, as the slide starts forward, the joint at the bolt link pin has a tendency to buckle downward. It is prevented from doing this by the tail of the feed rib on the bolt which extends backward under the bolt lock, also by the upper front surface of the bolt link being in contact with the locking surface of the bolt lock. Since the joint cannot buckle, the entire mechanism moves forward with the slide. When it has traveled about $\frac{1}{4}$ inch, the front end of the feed rib strikes

on the base of the top cartridge, which the magazine spring and lips are holding up in its path.

(2) *Feeding* (fig. 10).—The cartridge is carried forward about $\frac{1}{4}$ inch, when the nose of the bullet strikes the bullet ramp or guide on the breech of the barrel and is deflected upward toward the chamber. This action also guides the front end of the cartridge from under the magazine lips. The base of the cartridge approaches the center of the magazine, where the lips are cut away and the opening enlarged, and at this point is forced out of the magazine by the magazine spring. The base of the cartridge slides up the face of the bolt and under the extractor. Should the cartridge fail to

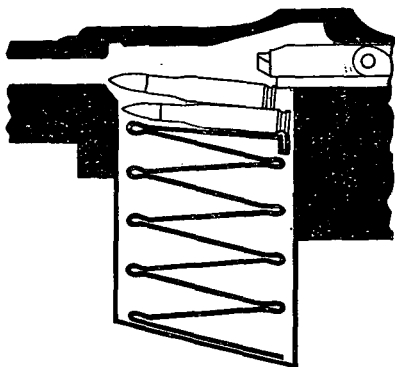

FIGURE 10.—Feeding.

slide under the extractor, the extractor will snap over its head as the bolt reaches the forward position. When the cartridge is released by the magazine, the nose of the bullet is so far in the chamber that it is guided by the chamber from this point on.

(3) *Locking*.—When the slide is about 2 inches from its forward position, the circular cam surface on the under side of the bolt lock begins to ride over the rear shoulders of the bolt supports on the sides of the receiver and the rear end of the bolt lock is cammed upward. The bolt link pin passes up above the line joining the bolt lock pin and hammer pin. The joint at the bolt link pin now has a tendency

to buckle upward, and the bolt lock being opposite the locking recess in the receiver is free to and does pivot upward about the bolt lock pin. The bolt link revolves upward about the hammer pin, forcing the bolt lock up, and a rounded surface on the bolt lock just above the locking face slips over the locking shoulder in the receiver, giving the lock a lever action which forces the bolt home to its final position. The two locking surfaces on the bolt lock and the receiver register as the hammer pin passes under the bolt link pin.

(4) *Igniting cartridge.*—The lug on the firing pin is buried in the slot on the under side of the bolt lock at all times except when the bolt is locked in the forward position. Therefore, the firing pin is locked away from the face of the bolt during all the rearward and forward motion of the bolt. When the hammer pin passes under the bolt link pin, which places the bolt lock into the locking recess in the top of the receiver, the firing pin has been released by the bolt lock. The slide and hammer move forward about $\frac{1}{10}$ inch farther, and the center rib of the hammer strikes the head of the firing pin a smart blow, thereby igniting the cartridge.

(5) *Termination of second phase.*—The forward end of the slide strikes a shoulder at the rear end of the gas cylinder tube, terminating the forward motion. The forward motion is not terminated by the hammer on the firing pin. This can be seen by examining the head of the firing pin when the gas cylinder tube is assembled to the receiver, and the bolt mechanism is in the forward position. The firing pin has still about $\frac{1}{16}$ -inch clearance from its extreme forward position.

NOTE.—The locking shoulder of the receiver is inclined forward. Its surface is perpendicular to the line through the bolt lock which the shock of the explosion follows; therefore the force of this shock is exerted squarely against the normal surface. The speed of the bolt mechanism is slowed down gradually from the instant that the bolt lock starts to rise until the hammer pin passes under the bolt link pin, when the speed is zero.

■ 22. **FUNCTIONING OF COMBINATION BUFFER AND RATE REDUCING MECHANISM** (fig. 11).—*a. Parts.*—The buffer and rate reducing mechanism consists of the following parts in the order given from front to rear:

(1) **Buffer tube**, which has four splined slots on the inside of the forward end for use in positioning the buffer head.

One of these slots only is used to anchor the buffer tube to the buffer head by means of the buffer key.

- (2) Buffer head.
- (3) Sear release, inserted in buffer head.
- (4) Buffer key, which holds sear release in buffer head and anchors buffer tube to buffer head.
- (5) Brass friction cup with concave interior which is split to allow for expansion; and a steel cone to fit into the cup.

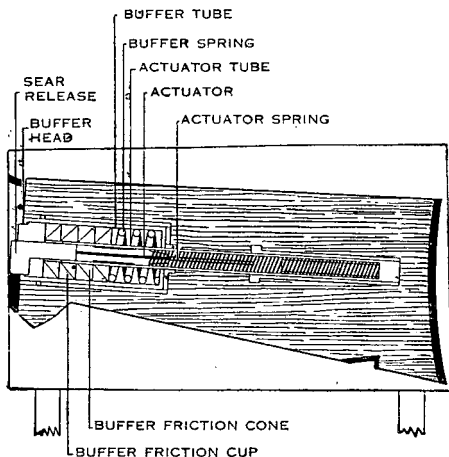

FIGURE 11.—Wooden working model of the combination buffer and rate-reducing mechanism.

Four of these cups and cones are placed one after the other in series.

- (6) Buffer spring.
- (7) Actuator, inside of cups, cones, and buffer spring.
- (8) Buffer tube cap.
- (9) Actuator tube.
- (10) Actuator spring, inside actuator tube.
- (11) Stock retaining sleeve lock washer.
- (12) Stock retaining sleeve.
- (13) Actuator stop.
- (14) Pin.

b. Action.—(1) When the automatic rifle is fired at the slow cyclic rate, the buffer head and sear release, struck by the rear end of the slide, move to the rear. The buffer head forces the friction cups over the cones, causing them to expand tightly against the tube, consequently producing considerable friction as the cups move back and compress the buffer spring. Thus the rearward action of the slide is checked gradually and there is practically no rebound. The buffer spring returns the buffer head and friction cups and cones to their original positions. After striking the buffer head and sear release, the slide moves forward until it is engaged by the sear. The delayed release of the sear is then accomplished as follows: The sear release when struck by the slide in turn strikes the actuator in the buffer. The actuator is driven to the rear inside the actuator tube against the actuator spring. It returns under the force of expansion of the actuator spring to drive the sear release forward against the camming surface on the rear of the sear, thus releasing the sear and permitting the rifle to continue its cycle.

(2) When the rifle is fired at the normal cyclic rate, the functioning of the combination buffer and rate reducing mechanism is the same as explained for the slow cyclic rate in (1) above except that the sear release is prevented from engaging the camming surface on the rear end of the sear by the sear release stop lever.

■ 23. FUNCTIONING OF TRIGGER MECHANISM.—*a.* The trigger mechanism (fig. 12) has three settings:

(1) *Normal cyclic rate (A).*—When so set, the sear is depressed as long as the trigger is held back, and the rifle will continue firing at a cyclic rate of about 550 rounds per minute until the magazine is emptied.

(2) *Slow cyclic rate (F).*—When so set, the sear is depressed, thereby disengaging the sear from the sear notch on the under side of the slide when the trigger is pulled. However, the mechanism is so constructed that the sear rises and engages in the sear notch when the slide comes back again, and the sear notch will not disengage until the sear release in the buffer depresses the rear end of the sear by riding over

the cammed end on the sear or until the trigger is fully released and then pressed. With this setting, the rifle will fire at the slow cyclic rate of 350 rounds per minute for the length of time the trigger is held completely to the rear, or one shot may be fired for each press and quick release of the trigger.

(3) *Safe (S)*.—When so set, the sear cannot be released from the sear notch by pressing on the trigger.

b. The action of the trigger mechanism is taken up in phases and should be followed on the mechanism itself as the explanation proceeds. Have the trigger group disas-

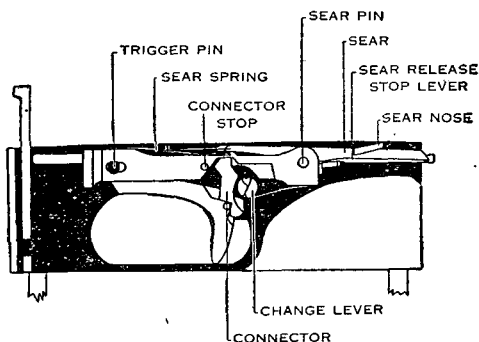

FIGURE 12.—Wooden working model showing trigger action.

sembled completely. Study the shape of the change lever and note the following:

- (1) It is a bar about $\frac{1}{4}$ inch in diameter.
- (2) It has three shallow longitudinal slots cut on top of the bar as the handle is held vertically.
- (3) The side of the bar is slotted in such a way as to leave a little tongue of metal in the center of the lower edge of the slot.

■ 24. **SETTING CHANGE LEVER.**—*a.* Assemble the change lever and spring to the trigger guard. The toe of the change lever spring is seated in one of the longitudinal slots on the change lever, and as the lever is turned from one position to another it seats in the other slots. The only function

of the forward end of the spring and the longitudinal slots is to hold the change lever in the position in which it is set.

b. Assemble the trigger and pin to the guard.

c. Turn the change lever to rear or safe position. In this position the slot is turned slightly upward, and the full surface of the bar is on the bottom. Pull the trigger. The rear top end of the trigger is slotted longitudinally, and the metal on each side of the slot forms two shoulders which rise against the bottom of the change lever bar.

d. Push the change lever over to the vertical position, which is the normal cyclic rate setting. Pull the trigger. The slot in the change lever is now turned to the front, and the two shoulders of the trigger, which before engaged the full surface of the change lever bar, now are free to pass up into the slot of the change lever; also the tongue of metal on the bottom of the change lever slot passes through the longitudinal slot in the end of the trigger.

e. Push the change lever forward to the slow cyclic rate position. The slot is now turned partially down and when the trigger is pulled the rear end of the trigger passes up into the change lever slot; also the tongue of metal in the bottom of the change lever slot is now turned back and does not pass through the slot in the end of the trigger as it did in the normal cyclic rate position.

■ 25. FUNCTIONING OF CONNECTOR.—a. Place the connector in its seat in the trigger. Set the change lever at "Safe." The trigger cannot be pulled as the shoulders on the heel of the trigger are against the change lever bar. Since the trigger cannot be pulled, the connector does not rise up through the slot in the sear carrier.

b. Set the change lever at the normal cyclic rate (vertical). Pull the trigger. The connector is now raised and held in a vertical position. The tongue on the change lever engages the toe of the connector as the trigger is pulled and holds the connector firmly in an upright position.

c. Set the change lever at the slow cyclic rate (forward). Pull the trigger. The connector is now raised and tips forward since the tongue on the change lever does not engage the toe of the connector. This tipping forward of the connector is aided by the cammed surface underneath the sear

carrier, and the connector is prevented from tipping too far forward by the connector stop which is the cross pin in the sear carrier.

■ 26. FUNCTIONING OF SEAR.—*a.* Completely assemble the trigger group. Set the change lever at "Safe." With the change lever in this position, as previously stated, the connector does not rise as pressure is applied against the trigger. Since the connector cannot be raised to lift the forward end of the sear which is pivoted in the middle, the sear nose on the rear end of the sear will remain engaged in the sear notch on the slide and the rifle will not fire.

b. Set the change lever at the normal cyclic rate (vertical). Press the trigger. The connector, being raised and held in a vertical position, raises the forward end of the sear, thus depressing the rear end. The rear end of the sear, being depressed, disengages the sear nose from the sear notch in the slide, allowing the operating parts to go forward. The slide will be free to move backward and forward as long as the sear nose on the sear is depressed by holding back on the trigger. The sear release stop lever operates as part of the sear and prohibits the camming action of the sear release on the rear end of the sear.

c. Set the change lever at the slow cyclic rate (forward). Press the trigger. As the trigger is pressed the connector rises, lifts the forward end of the sear, and depresses the rear end, thus disengaging the sear nose from the sear notch and allowing the slide to go forward. The connector is then cammed forward from under the sear, allowing the sear to return to its original position. The sear nose will then engage the slide and hold it momentarily to the rear until it is released by the sear release in the buffer mechanism acting on the cammed surfaces on the rear of the sear (par. 22*b*). This action of the sear release on the cammed surface of the sear will continue as long as the trigger is held, and the rifle will continue to fire at the slow cyclic rate of about 350 rounds per minute.

■ 27. FUNCTIONING OF SEAR RELEASE STOP LEVER.—*a.* With the change lever set at "Safe," the sear release stop lever functions as a part of the sear as outlined in paragraph 26*a*.

b. With the change lever set at the normal cyclic rate, the sear release stop lever functions as a part of and with the sear. As long as the trigger is pressed to the rear, the rear ends of both the sear and the sear release stop lever remain depressed and the rifle fires at the normal cyclic rate.

c. With the change lever set at the slow cyclic rate, as long as the trigger is pressed fully to the rear, the sear nose will rise to engage the slide after each shot; but, since the sear release stop lever remains depressed (held up at the front end by the connector), the sear release cams down the cammed end of the sear, thereby releasing the slide for each

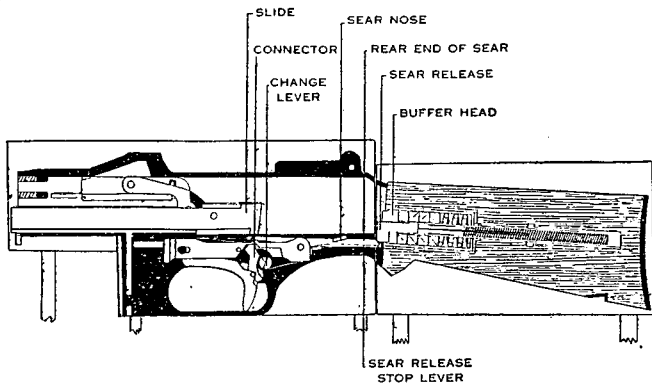

FIGURE 13.—Combined wooden working model to show functioning.

succeeding shot. If the trigger is quickly released as soon as pressed, both sear and sear release stop lever rise, thereby permitting the firing of single shots.

■ 28. **FUNCTIONING OF SPRINGS.**—The springs in the trigger group operate either to return the parts on which they work to their original positions or to hold them in such positions.

SECTION V

OPERATION

■ 29. **GENERAL.**—*a. Object.*—This section is designed to give the soldier instruction necessary for the operation of the rifle.

b. *When taken up.*—The operation of the automatic rifle will be taken up at any convenient time after instruction in care and cleaning (pars. 13 to 16) has been completed.

■ 30. USE OF DUMMY CARTRIDGES.—As prescribed in paragraph 18.

■ 31. TO LOAD THE MAGAZINE.—To load the magazine, place the wide end of the magazine filler over the top of the magazine, so that the groove in the magazine filler fits over the catch rib of the magazine. Hold the magazine in the same relative position that it occupies in the rifle, that is, with the catch rib toward the operator. Then, insert a clip of cartridges in the guides provided in the filler; and, with the right thumb near the base, push the cartridges into the magazine. Each magazine will hold 20 rounds (fig. 14). In case a magazine filler is not available, the magazine may be loaded by hand. This is accomplished by holding the magazine in the left hand, top up, catch rib toward the operator. Insert the cartridges singly in the top of the magazine, base of the cartridge toward the operator, with the thumb of the right hand, pressing downward until the cartridge is held firmly by the lips at the top of the magazine.

■ 32. TO LOAD THE RIFLE.—Press the magazine release, withdraw the empty magazine, if it has not already fallen out. Hold a loaded magazine with its base in the palm of the right hand, cartridges pointing to the front. Insert the magazine between the magazine guides in front of the trigger guard and push it home. Tap the bottom of the magazine with the right hand to insure that it is properly seated. The magazine can be inserted with the operating parts in either the rearward or forward position. It is ordinarily inserted after the rifle has been cocked.

■ 33. TO UNLOAD THE RIFLE.—Press the magazine release and withdraw the magazine, if it has not already fallen out. Let the bolt go forward by pulling the trigger.

■ 34. TO SET THE CHANGE LEVER.—a. For the slow cyclic rate of automatic fire, push the change lever to the forward position marked "F."

b. For the normal cyclic rate of automatic fire, set the change lever in the vertical position against the change lever stop marked "A."

c. To set the rifle at safe, depress the change lever stop and pull the change lever rearward until it covers the change lever stop. This position is marked "S." The change lever

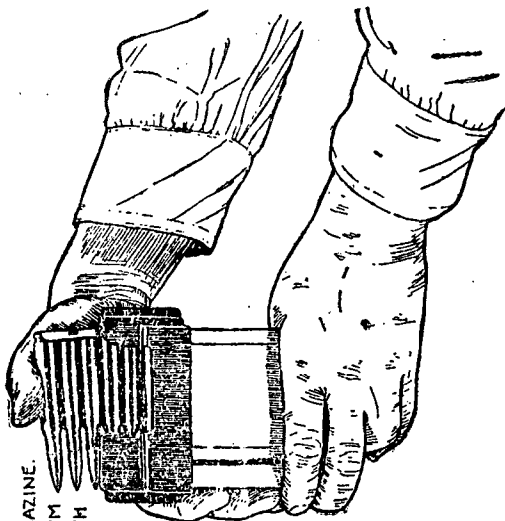

1. PLACE FILLER OVER MAGAZINE.
2. REST MAGAZINE ON FIRM BASE AND STEADY WITH LEFT HAND.
3. SEAT CLIP IN FILLER AND PUSH DOWN WITH THUMB AS IF LOADING RIFLE.

FIGURE 14.—To load the magazine.

stop prevents the accidental setting of the change lever at safe and, at the same time, permits a quick change from safe to either normal cyclic rate or slow cyclic rate.

■ 35. TO FIRE THE RIFLE.—Select the cyclic rate desired and press the trigger, holding it for the length of burst desired.

If single shots are desired, set the change lever for the slow cyclic rate, press the trigger, and immediately release it as the slide begins its forward movement.

■ **36. GAS ADJUSTMENT.**—*a. General.*—(1) The rifle normally should be operated on the smallest port, and this setting will never be varied unless the rifle shows signs of insufficient gas. To align the smallest port, screw the gas cylinder all the way into the gas cylinder tube, turn it back one complete turn, and then, by turning the gas cylinder through the shortest arc, place the smallest circle on the cylinder head toward the barrel. Lock the cylinder in position. If, upon firing, the rifle shows signs of insufficient gas, try to secure a better alignment of the *small port*, either by backing the cylinder off one complete turn or by screwing it in one complete turn. As soon as the proper setting has been obtained, the rifleman must note the position so that he can quickly assemble the cylinder to the proper point without trial. If the rifle still shows signs of insufficient gas, then set the cylinder on the next larger port by the method described above for the initial setting.

(2) The larger ports are provided for use in case the action of the rifle has been made sluggish through the collection of dirt and grit or the lack of oil under conditions which render prompt correction impracticable. For this reason the threads should be kept clean and oiled and the cylinder free to turn. The extractor, ejector, and the chamber of the barrel should be examined and cleaned and defects corrected when possible. Under adverse conditions, and when signs of insufficient gas become apparent, the cylinder should be unscrewed one-third turn, thus registering the medium circle and aligning the medium port with the gas orifice. Repeat this operation in order to connect the largest port with the barrel port.

b. Results of insufficient gas.—(1) Failure to recoil (usually due to misaligned or excessively clogged gas port or extremely dirty mechanism).

(2) Failure to eject.

(3) Weak ejection.

(4) Uncontrolled automatic fire (exceptional).

c. *Results of too much gas.*—(1) Excessive speed causing pounding.

(2) Excessive heat in gas operating mechanism.

■ 37. SAFETY PRECAUTIONS.—For safety precautions to be exercised in handling and firing the automatic rifle see paragraph 241.

SECTION VI

STOPPAGES AND IMMEDIATE ACTION

■ 38. GENERAL.—A stoppage is any unintentional cessation of fire. For combat efficiency, the automatic rifleman must understand the *cause* of common stoppages, observe a definite routine to *prevent* the cause, and act promptly to *reduce* a stoppage should one occur.

■ 39. CAUSES OF STOPPAGES.—The following table gives the usual cause(s) of common stoppages:

Nature of stoppage	Usual causes	Other causes
Failure to feed.....	Dirty or dented magazine; weak magazine spring; worn notch on magazine rib or spread lips at magazine opening.	Empty or ruptured cartridge case in chamber; excessive friction in operating parts.
Insufficient gas.....	Dirty gas cylinder; clogged gas ports; improper adjustment of gas cylinder; gas cylinder not oiled.	
Sluggish operation of parts.	Dirty parts; lack of oil; weak recoil spring; oil too heavy for cool weather.	Excessive oil (especially in chamber) may collect dirt or become sticky after heating.
Defective or improperly assembled parts.	Worn or broken firing pin, extractor, magazine catch, sear spring.	Improper or incomplete assembly such as incorrectly placing, or omitting, the connector.
Faulty ammunition.	Defective primer; lack of or reduced powder charge; bulged round.	

■ 40. PREVENTION OF STOPPAGES.—Almost all stoppages can be prevented by timely care and cleaning of the automatic rifle as set forth in paragraph 14 and in the following table:

POINTS TO BE OBSERVED BEFORE, DURING, AND AFTER FIRING

Item	Before	During (including temporary cessations)	After. (See par. 14.)
Bore.....	Remove oil.....	Keep free from dirt, mud, water and snow; clean during pauses.	Clean and oil.
Chamber.....	Clean thoroughly with chamber cleaning brush and patches.	Clean frequently. Use chamber cleaning brush during pauses while rifle is hot. Keep free from oil.	Clean thoroughly. Oil lightly.
Operating parts.	Work slide back and forth to insure free movement. Oil lightly if necessary.	Oil periodically. Keep out dirt and dust.	Clean and oil.
Gas system....	Verify proper setting of gas port.	Place 3 or 4 drops of oil in end of gas cylinder periodically during pauses.	Clean and oil.
Trigger mechanism.	Test at safe, slow and normal cyclic rate settings.	-----	Clean and oil.
Magazines....	Clean; remove dents; see that springs and catch function properly.	Handle carefully; keep out dirt and grit; avoid throwing in sand.	Disassemble; clean and oil.

■ 41. IMMEDIATE ACTION.—*a.* Immediate action is the procedure used to reduce common stoppages in the minimum time. This procedure, given in the table below, consists of a positive and unhesitating manual operation without detailed consideration of the cause.

b. It will be seen that the first phase (Pull, Push, Tap, Aim, Fire) is an automatic action, and that the second phase, when necessary, consists of only enough analysis and inspection to provide quick and positive action.

c. Ruptured cartridges may result from any one of several causes—excessive head space, dirty or sticky chamber, or defective cartridge cases.

d. If the rifle on a cold day fires single shots when the change lever is set on slow cyclic rate, it is due to sluggishness in the rate reducing mechanism or too heavy oil on the

RIFLE FAILS TO FIRE
IMMEDIATE ACTION

(Pull, Push, Tap, Aim, and Fire) (note 1)

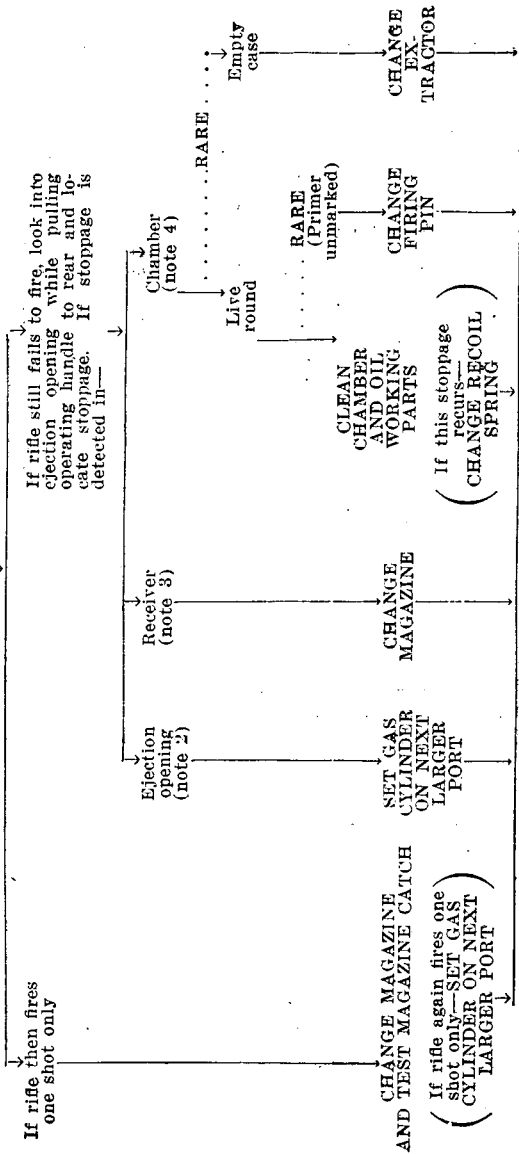

operating parts. Set the change lever on the normal cyclic rate until the rifle warms up.

e. In the event of stoppages that can not be remedied, the rifle should be reported for repair. (Such a stoppage would be the repeated rupturing of cartridges near the base due to excessive head space.)

NOTES

1. *Pull* operating handle to rear; *Push* operating handle forward; *Tap* up on magazine; *Aim*, and attempt to *Fire*. *This action will relieve 90 percent of all stoppages.*

2. This stoppage will be detected by empty case wedged in ejection opening by live round attempting to get into chamber.

3. This stoppage will be detected by absence of cartridge in receiver and chamber, or two cartridges attempting to get into chamber at same time, or bolt riding over cartridge and wedging it while it is halfway in chamber.

4. This stoppage will be detected by live round jammed into ruptured cartridge in chamber, or live round in chamber with primer marked, or (RARE) live round in chamber with primer unmarked, or (RARE) empty case in chamber.

SECTION VII

SPARE PARTS AND ACCESSORIES

■ 42. SPARE PARTS (fig. 15).—a. The parts of any rifle in time will become unserviceable through breakage or wear resulting from continuous usage. For this reason, spare parts are provided for replacement of the parts most likely to fail. These parts are for use in making minor repairs and in the general upkeep of the rifle. Twenty-round magazines also are issued as spares, the quantity being based on the allowance of ammunition authorized. Sets of spare parts should be maintained as complete as possible at all times, and all parts should be kept clean and lightly oiled to prevent rust. Whenever a spare part is used to replace a defective part in the rifle, the defective part should be repaired and substituted in the spare parts set, or a new one should be obtained. Parts that are carried in complete sets at all times should be assembled correctly and ready for immediate insertion in the rifle. The allowances of spare parts and of 20-round magazines are prescribed in Standard Nomenclature List No. A-4.

b. With the exception of the spare parts mentioned in

paragraph 43b (4); repairs or alterations by the using organizations are prohibited.

■ 43. ACCESSORIES.—*a. General.*—Accessories include the tools required for disassembling and assembling and for the cleaning and preservation of the rifle. They must not be used for any purpose other than as prescribed. There are a number of accessories the names or general characteristics of which indicate their uses or application. Therefore, detailed description or methods of use of such items are not outlined herein. However, accessories embodying special features or having special uses are described in *b* below.

b. Special.—(1) *Brush and thong, caliber .30, complete.*—This consists of the brush, the tip, the weight, and the cord. The thong weight and tip are made of brass and are provided with holes in which the thong cord is knotted. The tip is provided with a cleaning patch and is threaded on the end to receive the fiber bristle brush.

(2) *Brush, cleaning, caliber .30, M2.*—The brush consists of a brass wire core with brass bristles and tip. The core is twisted in a spiral and holds the bristles in place. This brush is distinguished from the one that is a part of the brush and thong by the type of bristles and lengths of threads on the tip, and is for use with the cleaning rod. It can be used with the thong only with difficulty, because of its stiff bristles.

(3) *Brush, chamber-cleaning, M1.*—The chamber-cleaning brush consists of a curved, flat, steel handle to which are hinged a chamber-cleaning brush at one end and a small, bristled dusting brush at the other end.

(4) *Case, accessory, and spare parts, M1918.*—This is a leather box-shaped case, approximately 2 inches wide, 4 inches high, and 6 inches long. This case should be carried at all times, and will normally be complete with the following spare parts and small accessories:

(a) Spare parts.—

1. Recoil spring.
2. Connector.
3. Two trigger pins.
4. Two firing pins.

5. Extractor and extractor spring.
6. Trigger guard retaining pin and spring.
7. Gas cylinder tube retaining pin and spring.
8. Sear spring.
9. Change lever spring.
10. Magazine catch spring.
11. Change lever stop and spring.
12. Change lever.

(b) *Accessories.*—

1. Fabric envelope, 3 by 5 inches, two-button.
2. Fabric envelope, 3 by 3 inches, one-button.
3. Oval oiler, 3-ounce with cap and chain (full of oil).
4. Chamber cleaning brush M1.
5. Combination tool.
6. Gas cylinder cleaning tool.
7. Ruptured cartridge extractor.
8. Brush and thong, complete.

(5) *Case, cleaning rod M1.*—This fabric case has five pockets, four of which hold the sections of the cleaning rod M1, while the fifth holds the cleaning brush, caliber .30, M2. The contents are secured in their pockets by a web flap and a buckle.

(6) *Rod, cleaning, jointed, M1.*—This steel rod consists of five sections, the first two permanently fastened together by a swivel joint. The first section has a slot for attaching the cleaning patch, and a threaded hole is provided for holding the cleaning brush. The rear section is provided with a tubular steel handle which turns on the rod. There are many other types of cleaning rods in use in the military service that may be used to clean the automatic rifle in garrison or bivouac. The cleaning rod M1, or the brush and thong complete, are the most practical cleaning accessories in the field or in combat.

(7) *Filler, magazine.*—The magazine filler is a pressed-steel adapter which is fitted over the top of an empty magazine when loading. Its method of use is shown in figure 14.

(8) *Extractor, ruptured cartridge, Mk. II.*—The ruptured cartridge extractor has the general form of a caliber .30 cartridge. It consists of three parts—the spindle, head, and sleeve. To use the ruptured cartridge extractor, the live car-

SPARE PARTS

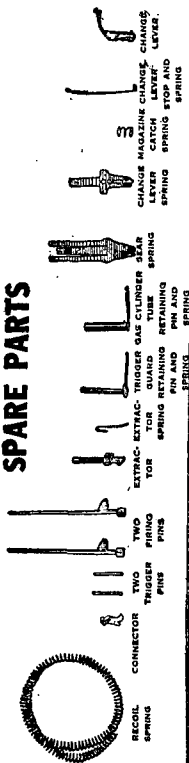

RECOIL SPRING
CONNECTOR
TWO TRIGGER PINS
TWO TRIGGER PINS
EXTRAC-TRIGGER FOR SPRING
TRIGGER GAS CYLINDER GEAR SPRING
CHANGE MAGAZINE LEVER SPRING
CHANGE CATCH LEVER SPRING

ACCESSORIES

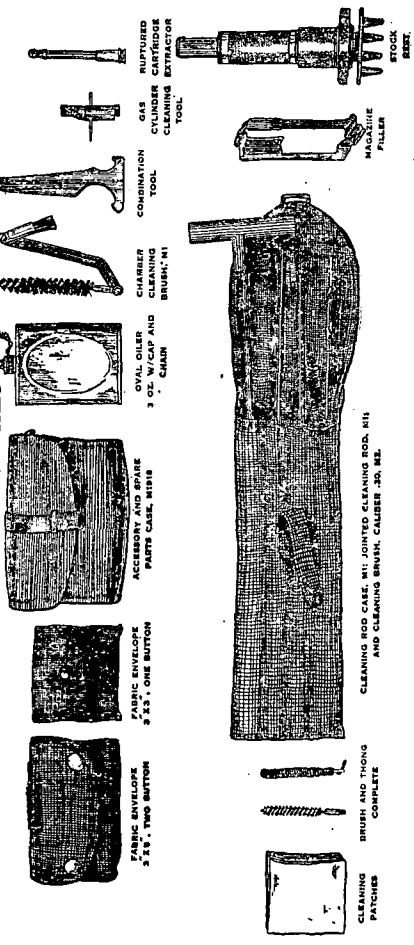

FABRIC ENVELOPE 5 X 9, TWO BUTTON
FABRIC ENVELOPE 3 X 5, ONE BUTTON
ACCESSORY AND SPARE PARTS CASE, M1918
OVAL OILER 3 OZ. W/CAP AND CHAIN
CHARBER CLEANING BRUSH, M1
COMBINATION TOOL
GAS CYLINDER CLEANING TOOL
RUPTURED CARTRIDGE EXTRACTOR

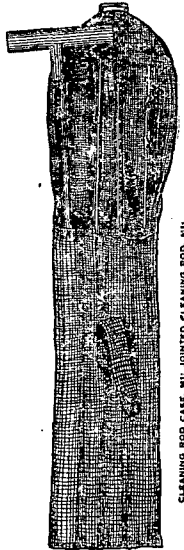

CLEANING ROD CASE, M1, JOINTED CLEANING ROD, M1 AND CLEANING BRUSH, CALIBER .30, M2.

CLEANING PATCHES
BRUSH AND THONG COMPLETE

MAGAZINE FILLER

STOCK REST

Figure 15—Spare parts and accessories.

tridges must be removed from the rifle. The ruptured cartridge extractor is then inserted through the opening of the ruptured cartridge case and pushed forward into the chamber. The bolt is let forward without shock so that the extractor of the rifle engages the ruptured cartridge extractor. As the operating handle is drawn back, the ruptured cartridge extractor, holding the ruptured cartridge on its sleeve, is extracted.

(9) *Sling, gun, M1907.*—The gun sling is fastened to the swivels provided on the rifle and is always carried thereon. It consists of a long and a short strap, either of which may be lengthened or shortened to suit the particular soldier using it.

(10) *Tool, combination.*—This tool consists of a steel body having two spanner wrenches and a screw driver end. The small spanner is used to turn the gas cylinder, and the large spanner will fit the rear of the barrel. The large screw driver is used to remove or tighten the forearm screws.

(11) *Tool, cleaning, gas cylinder.*—This is a special tool for cleaning the gas-operating mechanism. The ends of the tool body may be used to scrape carbon from the interior of the gas cylinder and from the face of the gas piston. The drift, which is attached to the body, may be used to remove carbon deposits from the gas ports and the grooves of the gas piston. The carbon must be completely removed, but care must be exercised to avoid scoring or damaging the gas cylinder walls or the grooves of the gas piston.

(12) *Wrench.*—There is no special wrench issued to remove the flash hider and bipod bearing from the muzzle end of the rifle barrel. Any suitable wrench that will fit a 1-inch nut may be used for this purpose.

(13) *Stock rest.*—The stock rest is used when it is desired to employ the automatic rifle for the delivery of fire on a final protective line, or to fire on a fixed point when the visibility is poor (par. 239).

SECTION VIII

AMMUNITION

■ 44. **GENERAL.**—Information in this section describes the several types of cartridges authorized for use in the Browning

automatic rifle, caliber .30, M1918A2, means of identification, care, use, and ballistic data.

■ 45. CLASSIFICATION (fig. 16).—Based upon use, the principal classifications of ammunition for this rifle are—

- a. *Incendiary*, for use against inflammable matériel.
- b. *Armor piercing*, for use against lightly armored vehicles, concrete shelters, and personnel.
- c. *Tracer*, for observation of fire and incendiary purposes.
- d. *Ball*, for use against personnel and light matériel targets.
- e. *Blank*, for simulated fire.
- f. *Dummy*, for training. (Cartridges are inert.)

■ 46. LOT NUMBER.—When ammunition is manufactured, an ammunition lot number, which becomes an essential part of the marking, is assigned in accordance with specifications. This lot number is marked on all packing containers and on the identification card inclosed in each packing box. It is required for all purposes of record, including grading and use, reports on condition, functioning, and accidents in which the ammunition might be involved. Since it is impracticable to mark the ammunition lot number on each individual cartridge, every effort should be made to maintain the ammunition lot number with the cartridges after they are removed from their original packing. Cartridges which have been removed from the original packing and for which the ammunition lot number has been lost are placed in grade 3. It is therefore necessary when cartridges are removed from original packings that they be so marked that the ammunition lot number is preserved.

■ 47. GRADE.—Current grades of existing lots of small-arms ammunition are established by the Chief of Ordnance and are published in Ordnance Field Service Bulletin No. 3-5.

■ 48. IDENTIFICATION.—a. *Markings*.—The contents of original boxes are readily identified by the markings on the box. Similar markings on the carton label identify the contents of each carton.

b. *Color bands*.—Color bands painted on the sides and ends of the packing boxes further identify the various types

of ammunition. The following color bands for cartridges are used:

Incendiary-----	red on yellow
Armor piercing-----	blue on yellow
Tracer-----	green on yellow
Ball-----	red
Blank-----	blue
Dummy-----	green

c. *Types and models.*—The following types and models of caliber .30 cartridges are authorized for use in this rifle:

- Incendiary.
- Armor-piercing, M2.
- Tracer, M1.
- Ball, M2.
- Ball, M1.
- Blank, M1909.
- Dummy, M1906 (corrugated).

When removed from their original packing container, the cartridges are identified, except as to ammunition lot number and grade, by their physical characteristics.

(1) *Incendiary.*—All caliber .30 incendiary ammunition is distinguished by the tip of the bullet nose, which is painted light blue. The bullets have gilding metal jackets.

(2) *Armor piercing.*—All caliber .30 armor-piercing ammunition is distinguished by the tip of the bullet nose, which is painted black. The bullets have gilding metal jackets.

(3) *Tracer.*—Caliber .30 tracer ammunition may be identified by the tip of the bullet nose, which is painted red.

(4) *Ball.*—All models of caliber .30 ball ammunition which are authorized to be used in the automatic rifle, except M2 of 1940 and earlier manufacture, have bullets with gilding metal jackets. The metal jacket of the earlier M2 ammunition is tin-coated. The gilding metal jacket of the present M2 bullet is copper-colored.

(5) *Blank.*—Blank ammunition may be identified by the absence of a bullet in the cartridge case.

(6) *Dummy*.—The caliber .30 corrugated dummy cartridge may be identified by the corrugations formed in the cartridge case.

■ 49. CARE, HANDLING, AND PRESERVATION.—*a*. Small-arms ammunition is not dangerous to handle. Care, however, must be exercised to keep the boxes from becoming broken or damaged. All broken boxes must be repaired immediately and all original markings transferred to the new parts of the box. The metal liner should be air-tested and sealed, if equipment for this work is available.

b. Ammunition boxes should not be opened until the ammunition is to be used. Ammunition removed from the airtight container, particularly in damp climates, is likely to corrode, thereby causing the ammunition to become un-serviceable.

c. The ammunition should be protected from mud, sand, dirt, and water. If it gets wet or dirty, wipe it off at once. Light corrosion, if it forms on cartridges, should be wiped off. However, cartridges should not be polished to make them look cleaner or brighter.

d. During marksmanship and combat training, no caliber .30 ammunition will be fired until it has been identified by ammunition lot number and grade.

e. Do not allow the ammunition to be exposed to the direct rays of the sun for any length of time. This is likely to affect seriously its firing qualities. Small-arms ammunition of all classes should be stored away from radiators, hot water pipes, and other sources of heat, since heat not only deteriorates ammunition, but also creates a fire hazard.

■ 50. STORAGE.—Whenever practicable, small-arms ammunition should be stored under cover. Should it be necessary to leave small-arms ammunition in the open, it should be raised at least 6 inches from the ground and covered with a double thickness of tarpaulin. Suitable trenches should be dug to prevent water from flowing under the pile.

■ 51. BALLISTIC DATA.—The approximate maximum ranges of the several types of models of caliber .30 ammunition

authorized for use in the Browning automatic rifle are shown below:

	<i>Yards</i>
Incendiary (Incendiary action up to 400 yards)-----	
Armor piercing, M2-----	4,000
Tracer, M1-----	3,500
Ball, M2-----	4,000
Ball, M1-----	5,500
Blank-----	20
Dummy, MI906 (corrugated)-----	None

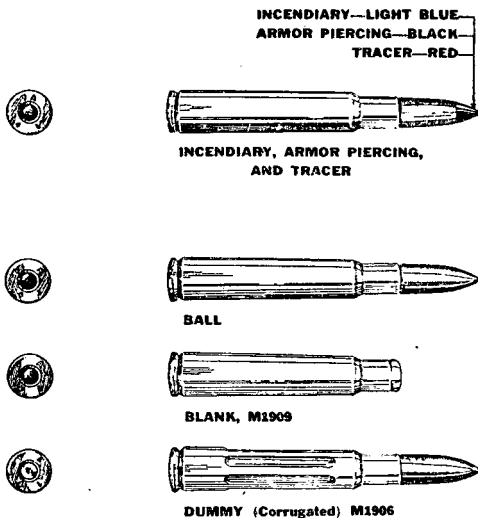

FIGURE 16.—Ammunition.

CHAPTER 2

MARKSMANSHIP, KNOWN DISTANCE TARGETS

	Paragraphs
SECTION I. General.....	52-54
II. Preparatory marksmanship training.....	55-80
III. Courses to be fired.....	81-83
IV. Range practice.....	84-93
V. Regulations governing record practice.....	94-124
VI. Targets and ranges.....	125-126

SECTION I

GENERAL

■ 52. **OBJECT.**—The object of this chapter is to provide a thorough and uniform method of training individuals to be good automatic rifle shots, and of testing their proficiency in firing at known distance targets with the Browning automatic rifle, caliber .30, M1918A2. This proficiency is vital to the effective use of the weapon in field firing, both for aimed fire and other types of fire (such as fire along a final protective line, par. 239), described in succeeding chapters.

■ 53. **FUNDAMENTALS.**—To become a good automatic rifle shot, the soldier must be trained in the following essentials of good shooting:

- a. Correct sighting and aiming.
- b. Correct positions.
- c. Correct trigger manipulation.
- d. Correct application of the fundamentals of automatic fire.
- e. Knowledge of proper sight adjustments.

■ 54. **PHASES OF TRAINING.**—*a.* Marksmanship training is divided into the following phases:

- (1) Preparatory marksmanship training.
 - (2) Range practice.
- b.* No individual should be given range practice until he has had a thorough course in preparatory training.

c. The soldier should be proficient in mechanical training before he receives instruction in marksmanship training.

d. Every man who is to fire on the range will be put through the preparatory course regardless of previous qualifications.

SECTION II

PREPARATORY MARKSMANSHIP TRAINING

■ 55. GENERAL.—*a. Steps in training.*—The purpose of preparatory marksmanship training is to teach the soldier the essentials of good shooting and to develop fixed and correct shooting habits before he undertakes range practice. Preparatory marksmanship training is divided into six steps, as follows:

- (1) Sighting and aiming exercises.
- (2) Position exercises.
- (3) Trigger manipulation exercises.
- (4) Automatic fire exercises.
- (5) Instruction in the effect of wind, sight changes, and use of the score book.
- (6) An examination covering all previous instruction in the Browning automatic rifle.

b. Training in the first four steps listed in *a* above is given in the sequence listed; each succeeding step involves the use of technique learned in preceding steps. Instruction in the effect of wind, sight changes, and the use of the score book is not a training step that need be given in any particular sequence, but will be given before the examination which is the final step prior to range practice. These subjects can be taught indoors during inclement weather.

■ 56. EQUIPMENT.—*a. List.*—For each Browning automatic rifle team—

- 1 sighting bar.
- 1 automatic rifle and rest. (Rest partially filled with sand for stability.)
- 1 3-inch sighting disk (fig. 17).
- 2 small aiming targets.
- 1 long range sighting disk.
- 1 small box.

- 1 target frame covered with blank paper for long range triangles.
- 1 score book for each man.
- 1 blank examination form as shown in paragraph 57e.
- 1 D-target with curtain for each three teams.

b. Preparation.—(1) *Sighting bar.*—Construct the sighting bar from trim lumber and tin strip to the dimensions and design shown in figure 17. The sighting bar, like all other equipment, should be constructed so as to present a neat appearance. The top of the sighting bar, its front and rear sight, and its eyepiece are painted black.

(2) *Automatic rifle and rest.*—An empty ammunition box, or any similar box with notches cut in the ends to fit the automatic rifle closely, makes a good automatic rifle rest. The automatic rifle is placed in those notches with the trigger guard just outside one end. The sling is loosened and pulled to one side. The box is half filled with earth or sand to give it stability.

(3) *Sighting disks.*—Sighting disks are of two sizes. The disk to be used at a distance of 50 feet is shown in figure 17. The disk to be used at 200 yards is constructed by pasting the black silhouette of a standard D-target on stiff backing and attaching a 4-foot handle. In the center of the sighting

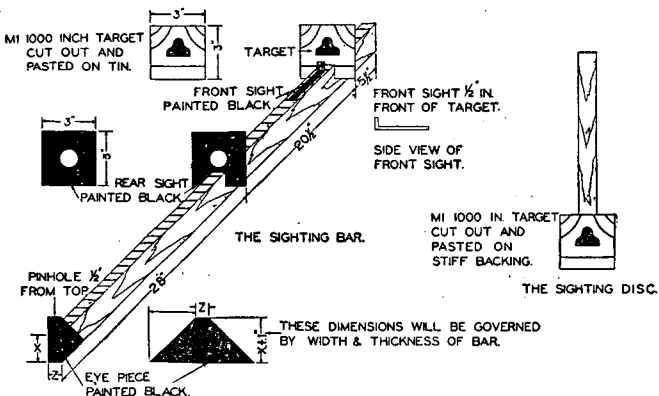

FIGURE 17.—Construction of sighting bar and sighting disk.

disks are holes of a size sufficient to admit the point of a pencil.

(4) *Blackening the sights.*—In all preparatory exercises involving aiming and in all range firing, when the sight or sights of the rifle have become so shiny that a clear-cut sight picture cannot be obtained, the sights should be blackened. Before blackening, the sights are cleaned and all traces of oil removed. The blackening is done by holding each sight for a few seconds in the point of a small flame, which is of such a nature that a uniform coating of lampblack will be deposited on the metal. Materials commonly used for this purpose include carbide or kerosene lamps, candles, small pine sticks, and shoe paste.

■ 57. DUTIES OF LEADERS.—*a. Battalion commander.*—He requires the officers and noncommissioned officers to be familiar with the prescribed methods of instruction and coaching, supervises the instruction within his battalion, and requires the companies to follow the preparatory exercises and methods of coaching carefully and in detail.

b. Company commander.—He requires that the prescribed methods of instruction and coaching be carried out carefully and in detail within his company, and supervises and directs the platoon leaders.

c. Platoon leader.—He supervises and directs the rifle squad leaders in training the Browning automatic rifle teams and examines the automatic riflemen in his platoon as outlined in paragraph 80.

d. Platoon sergeant and guide.—They assist in the instruction and perform any other duties as directed by the company commander and platoon leader. They may assist the platoon leader in conducting the examination referred to in *c* above.

e. Squad leader.—(1) He, or his assistant, sees that each man in his Browning automatic rifle team is occupied in the designated preparatory training.

(2) He, or his assistant, keeps a copy of the form shown below, and promptly enters the grades made by his men as the work progresses. He has this form ready for inspection by the platoon leader, or other higher commander at any time.

STATE OF INSTRUCTION

Name	Disassembling and assembling	Care and cleaning	Knowledge of functioning	Operation	Immediate action and stoppages	Sighting bar (first sighting and aiming exercise)	Aligning sights (second sighting and aiming exercise)	Making shot groups (third sighting and aiming exercise)	Prone position (with bipod rest)	Sitting position	Kneeling position	Assault fire position	Sight setting and aiming exercise	Trigger manipulation exercise	Automatic fire exercise	Replacing magazines	Taking windage	Taking elevation	Understanding of the zero of a rifle	Use of the score book	Final grade
Brown																					
Jones																					
Smith																					

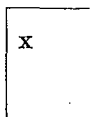

Fair

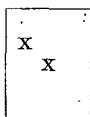

Good

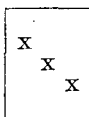

Very good

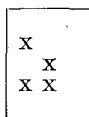

Excellent

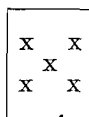

Excellent and has instructional ability

(3) He, or his assistant, requires the coaches to correct errors.

■ 58. METHOD OF INSTRUCTION.—*a.* The Browning automatic rifle team is the basic unit for preparatory marksmanship training. The duties of coach and pupil are rotated among the members of the team.

b. Correct shooting habits are developed during the preparatory exercises, and to this end careful execution of details is required. Training proceeds expeditiously to maintain interest. Care is taken to avoid holding the men in position until they become uncomfortable. Frequent short rests are given.

c. Instructors should receive a short refresher course in

preparatory marksmanship training prior to beginning the instruction of their men.

■ 59. DUTIES OF COACHES.—The successful conduct of the preparatory exercise largely depends upon the attention of the coaches to their duties. Officers and noncommissioned officers are specifically charged with the supervision of coaches as well as of pupils. They will require the coaches to have their pupils execute all steps of the preparatory exercises correctly. The positions of a coach are prescribed in paragraph 70. The duties of a coach are specific and, during the progress of the preparatory exercises, include necessary corrections of the pupil to see that—

- a. Sights are blackened, if necessary.
- b. Gun sling is properly adjusted, if used.
- c. Position is taken correctly.
- d. Slack is taken up promptly.
- e. Aim is taken carefully.
- f. Breath is held during aiming.
- g. Trigger is pressed properly.
- h. Pupil calls the shot.
- i. Firer observes proper safety precautions.

■ 60. FIRST SIGHTING AND AIMING EXERCISE: SIGHTING BAR.—Being careful to point out the various parts of the sighting bar as he refers to them, the instructor or squad leader shows a sighting bar to his group and explains its use as follows:

a. The front and rear sights on the sighting bar represent enlarged rifle sights. The rear sight is movable so that various sight alinements can be set.

b. The sighting bar is used in the first sighting and aiming exercise, because it shows the sights on a large scale and small errors can be seen easily and explained to the pupil.

c. The eyepiece has no counterpart on the rifle. The pupil is merely required to place his eye so that he will see the sights in exactly the same alinement as seen by the coach.

d. The movable target on the sighting bar provides a simple method of alining the sights upon a target.

e. The instructor explains the correct sight alinement, using a diagram similar to figure 18Ⓔ. He adjusts the

movable rear sight on the sighting bar to illustrate the correct sight alinement. The top edge of the front sight should fall on the horizontal diameter of the peep sight. There should be an equal amount of space on both sides of the front sight. Thus, the center of the top edge of the front sight is in the *exact center* of the peep sight. He has each pupil examine the set-up.

f. He sets off small errors in alinement and requires the pupils to detect and correct the errors noted.

g. The instructor illustrates a correct aim with the movable target in place so that the bottom edge of the target meets the top edge of the front sight in the *exact center* of the peep sight and has each pupil examine it (fig. 18②).

h. He adjusts the rear sight and movable target to illustrate small errors and has the pupils detect and correct them.

i. Then each man will be required to adjust the sighting bar with the correct aim until he is proficient.

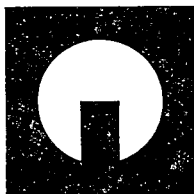

① A correct sight alinement.

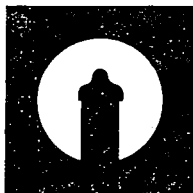

② A correct sight picture.

FIGURE 18.—Correct sight alinement and sight picture.

■ 61. SECOND SIGHTING AND AIMING EXERCISE: ALINING SILHOUETTE AND SIGHTS.—An automatic rifle for each team is placed in an automatic rifle rest and pointed at a blank sheet of paper mounted on a box. At each box, which is located 50 feet from the position of the rifle, a soldier is stationed as marker. The marker will have a small disk and a sharp-pointed pencil. The sights of the automatic rifle are blackened, if necessary, and set at 400 yards elevation. Being careful not to move the rifle or the rifle rest, the instructor takes a prone position (fig. 19) in rear of one of the automatic rifles, the line of the rifle barrel extending through the center of his right shoulder and hip

bone. His legs are spread well apart, and the inside of his feet are flat on the ground, or as nearly so as can be obtained without strain. Both elbows are on the ground. The chin rests in the palm of the left hand; the right hand is free for signaling to the marker. The cheek rests lightly on the stock and at such a point that the eye is approximately the same distance from the peep sight as it will be in actual firing. The instructor then directs the marker by command or improvised signals to move the small disk until the bottom of the silhouette is in correct alinement with the sights. The breath should be held when checking the final

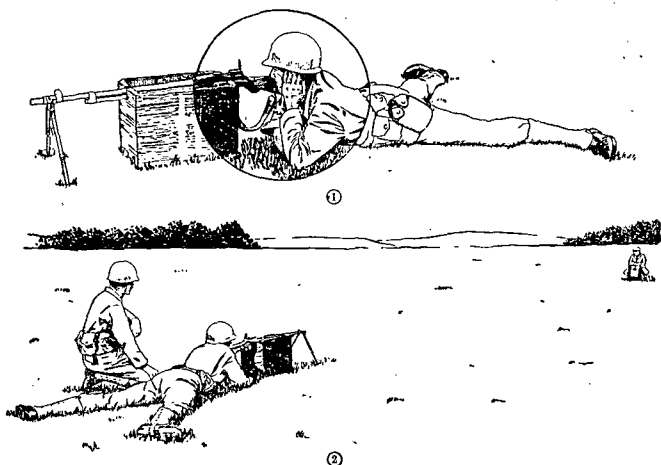

FIGURE 19.—Second sighting and aiming exercise.

sight alinement with the silhouette. The instructor commands: **HOLD** to the marker, and then moves away from the rifle and directs each pupil to look through the sights in order to observe the correct aim. The pupils are then required to execute the exercise, the instructor being careful to check the aim which each pupil obtains.

■ 62. **THIRD SIGHTING AND AIMING EXERCISE: MAKING SHOT GROUPS.**—*a.* The object of this exercise is to insure uniform and correct aiming.

b. The exercise is conducted as follows: the automatic rifle, with sights blackened if necessary, is placed in an automatic rifle rest and pointed at a blank sheet of paper mounted on a box 50 feet away (fig. 19). The pupil takes the correct prone position, as described in paragraph 61, and looks through the sights. The pupil or coach directs the marker to move the small disk until the bottom of the silhouette is in correct alinement with the sights, and then calls "Hold." The instructor checks the alinement and then calls, "Mark." The marker immediately marks a dot on the paper with a sharp-pointed pencil inserted through the hole in the silhouette. The small disk is removed and the dot numbered. The pupil repeats this operation until three dots, numbered 1, 2, and 3, have been made. These dots outline the shot group and the pupil's name is written under it. The size and shape of the group will be discussed with the coach or instructor and the cause of error pointed out and corrected (fig. 94). This exercise is repeated until proficiency is attained. A good group of three marks can be covered by the eraser of an ordinary pencil.

c. A similar exercise is held during the period of preparatory marksmanship training at 200 yards with the 26-inch movable silhouette. Properly handled, the exercise helps greatly to sustain interest in the work and to teach correct aiming. At 200 yards, a man should be able to make a shot group that can be covered with the small (3-inch) sighting disk. Movement of the disk is controlled by prearranged signals from the coach or instructor (fig. 20).

d. Tracings are made of each man's 200-yard shot group. These tracings are marked with the men's names, turned over to the platoon leader for his information, and shown to the men with appropriate mention of errors to be corrected. Competition between the automatic rifle teams, to see which can make the smallest shot groups, is of value in creating interest in this exercise.

■ 63. POSITION EXERCISES.—Instruction in position will include the use of the gun sling, use of the hinged butt plate, adjustment of the bipod legs, holding the breath, and aiming in each position. Small targets are set up for each position to assist the aim.

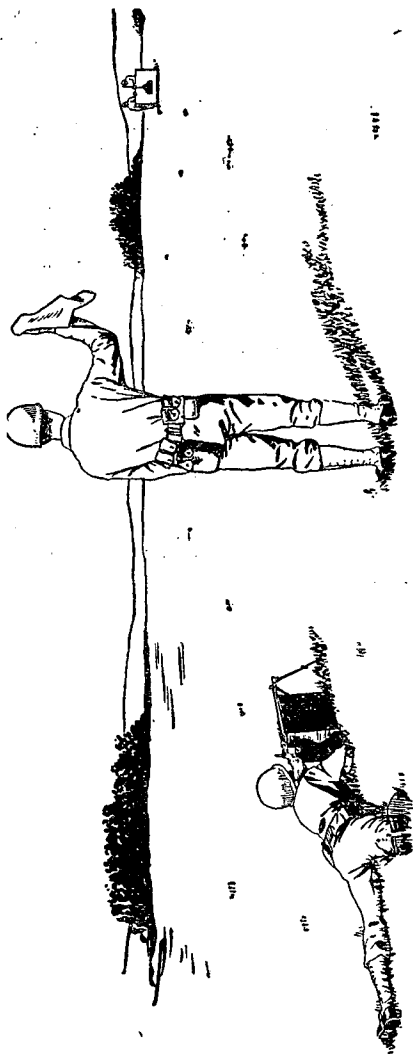

FIGURE 20.—Third sighting and aiming exercise with the aid of an assistant instructor.

a. General rules.—(1) All positions should be learned thoroughly, but it is impressed upon the soldier that the prone position with the bipod rest is used whenever possible, and that he must seek terrain which will enable him to use this position.

(2) Upon assuming any position there is some point to which the rifle naturally points, without effort on the part of the firer. If this point is not the center of the target, the whole body must be shifted so as to bring the rifle into proper alinement. Otherwise, the firer will be firing under a strain, because he will be pulling the rifle toward the target by muscular effort for each shot.

(3) In all position, except prone, the bipod legs are locked along the barrel (they need not be telescoped).

(4) The right hand grasps the small of the stock with the thumb on top of the stock.

(5) In the sitting and kneeling positions, the left hand is underneath the forearm of the rifle at such a place as will enable the firer to keep the rifle elevated and pointed at the target. The left wrist is straight. The rifle is resting on the heel of the hand in the crotch formed by the thumb and index finger. The left elbow is as nearly under the rifle as it can be placed without strain. In the prone position, the left hand grasps the small of the stock behind the right hand.

(6) The trigger is pressed with the index finger.

(7) The cheek rests firmly against the stock and as far forward as possible without strain to bring the eye near the rear sight.

(8) The automatic rifle is not fired from the left shoulder.

(9) The hinged butt plate is optional except in the prone position.

b. Gun sling.—(1) The gun sling, properly adjusted, is of great assistance in shooting in all positions except prone in that it helps to steady the rifle. Each man is assisted by the instructor in securing the correct adjustment for his sling. In a firing position, the sling is adjusted to give firm support without discomfort to the soldier. The gun sling is readjusted for drill purposes by means of the lower loop without changing the adjustment of the upper loop.

(2) There are three authorized adjustments: the loop

sling, the hasty sling, and a special adjustment for the assault fire position. The hasty sling is more rapidly adjusted than the loop sling, but it gives less support. The sling is not used on the arm when firing in the prone position.

(a) Loop adjustment.

1. Loosen the lower loop.
2. Pull the sling over to the left of the rifle, insert the left arm through the upper loop from the right side of the sling to the left. Work the left arm through the sling so that the upper loop is near the shoulder and well above the biceps muscle.
3. Pull the keepers and hook close against the arm to keep the upper loop in place.
4. Carry the left hand out and over the sling and grasp the forearm of the rifle near the center so as to cause the sling to lie smoothly along the back of the hand and wrist. The lower loop, not used in this adjustment, should be loose enough to prevent any tension. The ends should not be removed from the swivels.

(b) Hasty sling adjustment.

1. Loosen the lower loop and readjust to the proper length.
2. Twist the sling one-half turn to the left.
3. Grasp the forearm of the rifle near the center with the left hand and grasp the small of the stock with the right hand.
4. Throw the sling to the left and catch it above the elbow and high on the arm.
5. Remove the left hand from the rifle, pass the left hand under then over the sling, and regrasp the rifle with the left hand so as to cause the sling to lie flat along the hand and wrist.

(c) Assault fire adjustment.

1. Loosen the sling to approximately its full length (depending upon the size of the firer).
2. Pass the sling over the head and place it upon the left shoulder so that it lies smoothly over the shoulder and across the back.

3. With the right hand, loop the sling under and around the outside of the stock.
4. With the left hand between the sling and forearm of the piece, grasp the forearm near the center so that the sling lies smoothly along the back of the hand and wrist.

c. Hinged butt plate.—In the sitting, kneeling and if possible, in the antiaircraft positions, the hinged butt plate should be used, providing the conformity of the man's body permits. The hinged butt plate should be placed on the right shoulder as near to the junction of the neck and shoulder as possible. The hinged butt plate is always used in the prone position.

d. Bipod.—In adjusting the bipod for the prone firing position, the ends of the bipod leg tubes are seated in the recesses provided in the bipod body and then tightened by the bipod body wing screws. This prevents the legs from folding during firing. Next, the bipod legs are adjusted in length so that the rifle is pointing at the target when the butt is placed on the shoulder of the firer, and tightened to prevent telescoping.

e. Holding the breath.—To insure steadiness, the breath is held during aiming. To accomplish this, take an ordinary breath, let out a little, and hold the rest by closing the throat, not by action of the diaphragm. The firer should be comfortable, relaxed, and steady while aiming and pressing the trigger. He should not attempt to hold the breath so long as to become unsteady.

f. Aiming.—The rifle is carefully aimed in each position.

g. Canting the rifle.—In all positions the rifle is held squarely, that is, not tipped or canted from a vertical plane passing through its long axis. It should be understood, however, that unless it is pronounced, this error in position will not materially affect the aim nor the strike of the burst at short ranges.

h. Procedure in conducting position exercises.—Following explanations and demonstrations, the instruction becomes individual by the coach and pupil method. Small silhouettes are used as aiming points. These silhouettes are placed at a range of 1,000 inches and at different heights so that, in

aiming from various positions, the automatic rifle will be nearly horizontal. Standard known distance targets may be installed at distances used on the known distance range. The instructor may initiate an exercise by a command such as PRONE (SITTING, KNEELING) POSITION EXERCISES; WORK AT WILL. Each pupil, after checking to see that his sights are not shiny, adjusts his sling, takes position, takes up the slack, aims carefully, and holds his breath while aiming. As soon as his aim becomes unsteady, the exercise ceases. After a short rest, the pupil repeats the exercise without further command. The trigger is not pressed in the position exercise. Exercises are conducted in all positions.

i. Duties of coach.—In the position exercises, the coach sees that the—

- (1) Sights are blackened (when necessary).
- (2) Gun sling, when used, is properly adjusted, is tight enough to give support, and is high up on the arm.
- (3) Proper position is taken.
- (4) Slack is taken up properly.
- (5) Pupil aims.
- (6) Breath is held while aiming. The coach checks the pupil's manner of holding his breath by watching his back.

■ 64. PRONE POSITION (fig. 21).—*a.* The automatic rifleman lies down in rear of the rifle, the line of the barrel extending through the center of his right shoulder and right hip bone. His legs are spread well apart, the inside of the feet flat on the ground or as nearly so as can be attained without sprain. The hinged butt plate fits snugly on the back part of the shoulder, near the neck; the butt of the rifle is pressed firmly into the hollow of the shoulder. The shoulders are on the same level. The elbows are out to the sides and on the same line, so that the forearms form an angle at the small of the stock approximately equal to the angle formed by the bipod legs at the muzzle. The right hand grasps the rifle at the small of the stock with the thumb on top, the index finger on the trigger, and the remaining fingers curled with a strong grip under and around the stock exerting pressure to the rear. The left hand grasps the small of the stock in rear of the right hand, wrist straight, fingers uppermost, thumb extending under the stock, exerting pressure down

and to the left. Both hands hold the piece firmly against the shoulder.

b. When the firer is in the correct position, the rifle is pointed at the center of the target. Small adjustments in elevation, to cause the rifle to point at the exact part of the target desired, are made by moving the elbows closer together

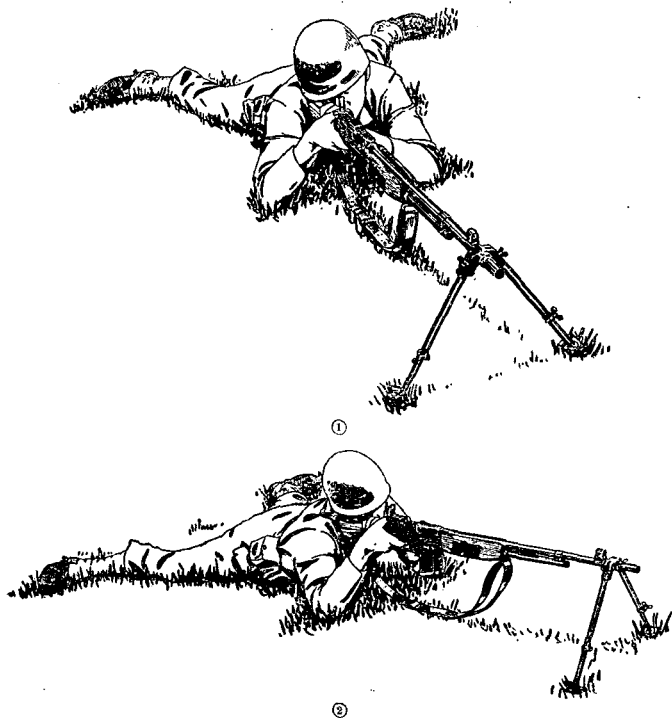

FIGURE 21.—Prone position.

or farther apart. Large vertical corrections are made by readjusting the bipod legs. All lateral movements of the rifle are made by shifting the entire body right or left, as desired. Figure 95 shows poor shot patterns due to a faulty prone position.

c. The soldier is trained to assume the correct prone position, aided by a coach who adjusts the legs of the tripod for height.

d. Following this training, the soldier will assume the correct prone position, adjusting the bipod without the aid of a coach. In doing this, it is necessary to remove the weapon from the shoulder, slide around to the side, and make the adjustment. The firer should be trained to adjust the bipod correctly for his height the first time. (Coach and pupil should be required to handle the rifle habitually by means of the wooden forearm to prevent serious burns during range and field firing.)



FIGURE 22.—Sitting position

■ 65. SITTING POSITION (fig. 22).—The firer sits half faced to the right; feet well apart and well braced on the heels which are slightly dug into the ground; ankles relaxed; body leaning well forward from the hips with back straight; both arms resting inside the legs and well supported; cheek resting firmly against the stock and placed as far forward as possible without straining; left hand grasping the rifle as far forward as convenient and comfortable, wrist straight, rifle placed in the crotch formed by the thumb and index finger and resting on the heel of the hand. In this position the feet may be slightly lower than the ground on which the firer sits. Sit-

ting on a low sandbag is authorized. Necessary changes to adapt the position to the conformation of the man are authorized. Instruction in the sitting position is limited to that sufficient to acquaint the men with it, as the use of this position is regarded as exceptional.

■ 66. **KNEELING POSITION** (fig. 23).—The firer kneels half faced to the right on the right knee, sitting on the right heel, the left knee bent so that the lower left leg is vertical as viewed from the front; left arm well under the rifle and resting on the left knee with the point of the elbow beyond the kneecap; right elbow approximately at the height of the shoulder; cheek resting firmly against the stock and placed



FIGURE 23.—Kneeling position.

as far forward as possible without strain. Sitting on the side of the foot instead of the heel is authorized. The center of balance of the firer should be low and forward. Like that in the sitting position, instruction in the kneeling position is limited to that sufficient to acquaint the men with it, as the use of this position is regarded as exceptional.

■ 67. **ASSAULT FIRE POSITION** (fig. 24).—In this position, the automatic rifle is held with the butt pressed firmly against the body under the right arm. For sling adjustment, see paragraph 63b(2)(c).



①



②

FIGURE 24.—Assault fire position.

■ 68. ANTI-AIRCRAFT FIRE POSITION (fig. 25).—*a.* The position used in firing at aerial targets is a modified kneeling position.

b. In assuming this position, the firer kneels on his right knee, body erect, buttocks *not* resting on the right heel. The left leg is straight without stiffness, the foot pushed well to the left front and turned slightly to the right at the ankle. The sling is not used. The rifle is held with the right hand grasping firmly at the small of the stock, the left hand grasp-

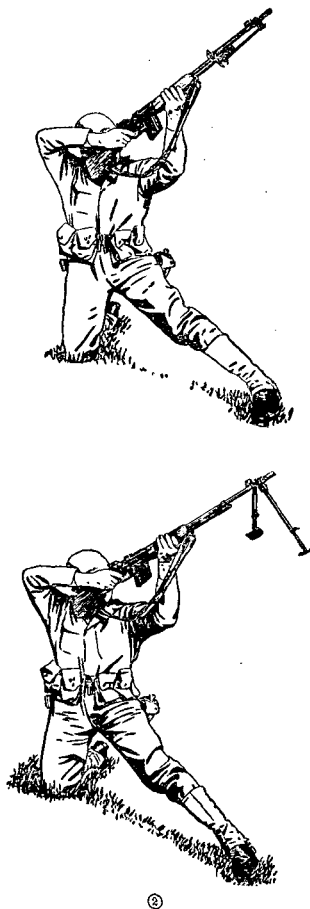

FIGURE 25.—Antiaircraft fire position.

ing the forearm. The right elbow is on a level with or higher than the right shoulder; the left elbow is as nearly under the rifle as possible. The bipod legs are folded and clamped along the barrel if time permits.

■ 69. MOVING GROUND TARGET FIRING POSITIONS.—The prone position is used when the angular traverse is small and permits the tracking of the moving ground target. When this is not possible, the antiaircraft position (par. 68) or a modified antiaircraft position is used.

■ 70. POSITIONS OF COACH.—*a. Firer in prone position.*—The coach lies on his left side, on the left of the firer, his head slightly in advance of the head of the firer so that he can observe the firer's eyes, chest, hands and shoulders. From this position, the coach may rise to observe the back, legs, and general position of the firer.

b. Firer in any position other than prone.—The coach kneels or stands directly in rear of the firer, to support the firer in the event of a runaway gun. The coach may move to other positions, if necessary, to carry out his duties. He must never allow any part of his body to get in front of the rifle, and must stay clear of the ejection opening.

■ 71. SIGHT SETTING EXERCISE.—*a.* The purpose of sight setting exercises is to teach accurate and rapid sight setting.

b. The instructor explains that there is an open sight and a peep sight; that the open sight (battle sight) corresponds to a sight setting of 300 yards; that the peep sight is set at the desired elevation when the index line through the peep sight is set opposite the desired elevation graduation on the sight leaf, and that, if the click brings the index line slightly above or below the desired range, the sight adjustment is left in that position and not at a part click. He explains that the elevation scale on the sight leaf is not graduated below the 300 yards elevation and usually the index line of the peep sight can be lowered little below the 300 yard elevation. (The mil scale on the left side of the sight leaf is used in setting the sights when firing from position defilade (par. 240) and in low visibility firing (par. 239). Turning the knob on top of the sight leaf clockwise moves the sight slide up 1 mil for each click; turning the knob counterclockwise moves the sight slide down 1 mil for each click.) He explains that one click of the windage knob moves the rear sight 1 mil (point of windage), that turning the windage knob forward (up) moves the rear sight to the right, that turning it to the

rear (downward) moves the sight to the left. Fractions of a point of windage may be set on the rear sight. (On earlier type rear sights that have no windage gage, the rifle is zeroed by moving the front sight blade right or left as required. After being zeroed by moving the front sight, corrections for wind are made by aiming to the right or left). The instructor then has a trained soldier assume the correct prone position with the automatic rifle and demonstrate the sight setting exercise as follows:

(1) The instructor announces the range and windage, for example, "Range 500, left one-half click."

(2) The soldier at the rifle raises the sight leaf, sets the sight with the announced range and one-half click (point) of left windage, and resumes the correct firing position.

(3) The instructor checks the sight setting.

c. Each group then performs the exercise explained above, under the supervision of its group instructor, until all are proficient in accurate and rapid sight setting.

■ 72. SIGHT SETTING AND AIMING EXERCISE.—a. The purpose of the sight setting and aiming exercise is to develop accuracy and speed in setting the sights and aiming the rifle.

b. The target shown in figure 27 is set up 1,000 inches from the rifle; a trained soldier is in the correct prone position with the bipod correctly adjusted. The instructor then demonstrates the exercise as follows:

(1) The instructor announces the range and windage and designates the target, for example, "Range 300, right three-fourths click, figure No. 1." After announcing the range and windage, the instructor pauses a sufficient length of time to permit the automatic rifleman to set the sights, and then designates the target. The automatic rifleman, having set the sights, then moves his body and the rifle until the sights are accurately alined upon the designated aiming point.

(2) The instructor then checks the sight setting, pointing out the errors, if any.

c. The men then perform the exercise explained above under the supervision of the group instructors until all are proficient in setting the sight and aiming the rifle on a designated aiming point within a time limit of 10 seconds.

Each exercise will start with the sight leaf down and the slide set at 500 yards.

■ 73. TRIGGER MANIPULATION EXERCISE.—*a. General.*—The trigger is pressed in such a way as to fire the first shot without affecting the aim. This is accomplished by holding the aim steadily while pressing the trigger promptly with a constantly increasing pressure. This pressure is applied toward the rear by the independent action of the index finger, until the bolt is released. The length of burst is dependent on the amount of time the trigger is held all the way to the rear. In firing bursts at the slow cyclic rate, the trigger must be pressed quickly all the way to the rear or a burst at the normal cyclic rate will occur. To fire single shots, the change lever is set at the slow cyclic rate, the trigger must be pressed quickly all the way to the rear, and *immediately* released. This can be accomplished if the trigger is released before the slide reaches its forward position. Once taught, these methods of pressing the trigger are carried out in all preparatory exercises or the value of the practice will be lost.

b. Trigger manipulation.—Trigger manipulation exercises are carried out in the preparatory exercises regardless of the fact that the men undergoing instruction may have just completed firing with the United States rifle, caliber .30, M1903, or the United States rifle, caliber .30, M1. The forward movement of the bolt when the trigger is pressed is confusing to many men and causes them to allow the alinement of the sights to become incorrect. The rifle is held steady and in perfect alinement during this forward movement.

c. Taking up trigger slack.—The first movement of the trigger which takes place when light pressure is applied is called "taking up the slack." It is part of the position exercise, because this play must be taken up by the finger as soon as the correct position is assumed and before careful aiming is begun. The entire amount of slack in the trigger is taken up by one positive movement of the finger.

d. Calling the shot.—The pupil always notices where the sights are pointed at the instant the rifle is fired, or when the bolt reaches its forward position in simulated fire, and calls

out at once where he thinks the bullet will hit. In automatic fire he calls the first shot.

e. Scope of instruction.—(1) The pupil is first taught trigger manipulation in the prone position. In this position, he can hold steadily while he presses the trigger. After proficiency is obtained in the prone position, trigger manipulation is practiced in the sitting and kneeling positions.

(2) In all exercises where fire is simulated, men will assume the correct position, carry out the correct principles of aiming, pressing the trigger, and calling the shot.

■ 74. EXERCISES IN CHANGING MAGAZINES (fig. 26).—*a.* Exercises should be conducted in which the soldier changes his own magazines. In these exercises, the following points should be stressed:

(1) In the prone position when the last shot (burst) in the magazine is fired, the automatic rifleman pushes the magazine release with his right thumb, at the same time pulling the operating handle all the way to the rear and pushing it forward with the left hand. He then withdraws the magazine with his left hand, if it has not fallen out of its own weight. When in the kneeling, sitting, and anti-aircraft positions, the automatic rifleman removes the rifle from the shoulder, places the butt on the thigh, presses the magazine release with the right thumb (if necessary, removes the magazine from the rifle with his left hand), then with the right hand pulls the operating handle to the rear and then pushes it forward.

(2) Full magazines are so placed in the belt that, when grasped and carried forward, the long portion will be to the rear. Thus, they may be readily inserted in the magazine opening in the receiver.

(3) Empty magazines are picked up and placed in the belt. This habit will minimize loss of magazines during firing and field combat.

(4) Each soldier changes his own magazines. He must be able to do it in 2 to 4 seconds while in any position. He tests all magazines before loading them to see that they will fall out of their own weight when empty.

b. These operations are taught as a drill, in which the following points should be carefully observed:

(1) Magazines are placed in the magazine belt so that when grasped and carried forward by the right hand the long portion will be to the rear.

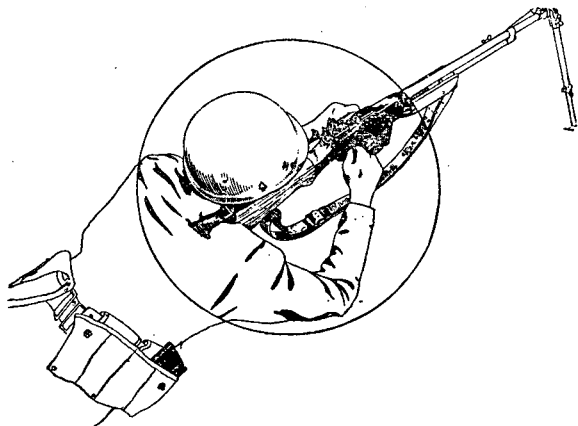

① Pressing magazine release with right thumb and drawing operating handle to rear with left hand.

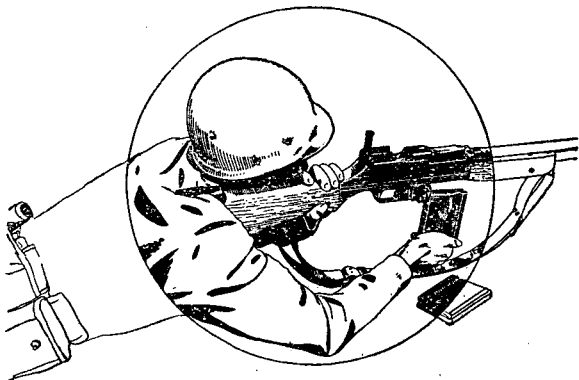

② Inserting new magazine.

FIGURE 26.—Changing magazine.

(2) After the last shot, the operating handle is drawn to the rear and then pushed forward.

(3) Magazine is dropped out after the last shot.

(4) The new magazine is drawn from the belt and placed in the receiver with one rapid, smooth movement.

(5) Empty magazines are picked up and placed in the belt. In known distance range firing, they will be placed in the belt at the conclusion of the firing of the exercise.

■ 75. AUTOMATIC FIRE EXERCISE.—*a.* Automatic fire exercises enable the soldier to gain skill in the manipulation of the automatic rifle. Efficient manipulation is an important factor in automatic rifle firing.

b. Automatic fire exercises are held at 1,000 inches on the United States rifle, caliber .30, M1, target (fig. 27). The exercises include observance of the fundamentals of sighting, positions, and trigger manipulation as taught in the preceding exercises.

c. Automatic fire exercises are conducted as follows:

(1) The instructor announces the range as "Range, 300," and designates the target and number of rounds as "Figures 5 to 6, 16 rounds."

(2) The automatic rifleman sets his sights at the announced range and aims at figure No. 5. He simulates firing a 2-round burst, traverses right to the next figure, and simulates firing another burst of 2 rounds, and so on until he has completed the simulated firing of 16 rounds.

d. The duties of the coach in automatic fire exercises are to insure that—

(1) The sight is set for the range designated.

(2) The correct position is taken.

(3) The slack is taken up promptly.

(4) The breath is held while aiming.

(5) The trigger is pressed properly.

(6) Each time the pupil completes the simulated firing of two rounds on a figure, he promptly traverses right to the next figure.

(7) The pupil aims at the proper figure on the target by cautioning him after each burst to shift his aim to the next figure.

(8) The eye is kept on the target, the elbows are kept in place, and the butt of the rifle is kept to the shoulder.

(9) The automatic rifle is reloaded with an empty magazine quickly and without fumbling.

■ 76. WINDAGE.—*a. Direction of wind.*—The horizontal clock system is used to describe the direction of the wind. In this system, the firer is assumed to be at the center of a clock and the target at 12 o'clock. A 3 o'clock wind then blows directly from the right, a 9 o'clock wind directly from the left, and other winds from their corresponding directions on the clock. Right windage is taken to counteract the effects of winds coming from the right of the clock and left windage to counteract those coming from the left.

b. Windage rule.—The range (expressed in hundreds of yards) multiplied by the velocity of the wind and divided by 40, equals the number of clicks to allow for a 3 o'clock or a 9 o'clock wind. The amount of windage to use for the first shot is determined by the above rule. W. D., A. G. O. Form No. 82 (Combination Score Book) (29 March 1942) will be altered to conform with this rule.

c. Windage-gage rule.—One click of the windage knob (or one point of windage), which corresponds to 1 mil, moves the strike of the bullet 1 inch on a target at 1,000 inches, 36 inches (1 yard) at 1,000 yards, or one-tenth of 36 inches, 3.6 inches, per 100 yards of range. For purposes of this rule, a click of the windage knob will be considered to move the strike of the bullet 4 inches for each 100 yards of range. Right windage moves the strike of the bullet to the right, left windage to the left. W. D., A. G. O. Form No. 82 (29 March 1942) will be altered to conform with this rule.

■ 77. ELEVATION.—*a. Range.*—Changes in elevation are made on the sight of the rifle for the primary purpose of adjusting for range.

b. Effect of light.—Light has an effect upon aim, generally causing men to aim slightly lower in a poor light than in a good one. Slight corrections in elevation are therefore necessary at times for this reason.

c. Elevation rule.—One click of the elevating knob, which is 1 mil, moves the strike of the bullet 1 inch on a target at 1,000 inches, 36 inches (1 yard) at 1,000 yards, and one-tenth of 36 inches, or 3.6 inches, per each 100 yards of range. For purposes of this rule, a click of the elevating knob will be considered to move the strike of the bullet 4 inches for each 100 yards of range. W. D., A. G. O. Form No. 82 (29 March 1942) will be altered to conform with this rule.

■ 78. EXPLANATION OF ZERO.—*a.* The zero of an automatic rifle for each range is that sight setting, both elevation and windage, which will place the center of the shot group in the center of the silhouette on a normal day when there is no wind. It may vary for the same rifle with different men on account of differences in eyesight. Each man should be required to know the zero for his own rifle for the various ranges.

b. Instructions for zeroing the rifle on a 1,000-inch range and on the known distance range are given in paragraph 90.

■ 79. SCORE BOOK.—W. D., A. G. O. Form No. 82 (29 March 1942) is used for both the automatic rifle and the service rifle.

■ 80. EXAMINATION.—*a.* Men will be examined by the platoon leader prior to proceeding to range practice to determine their proficiency in the subjects covered in chapter 1 and in this section.

b. This examination consists of questions, as indicated below, which are designed to bring out the soldier's knowledge of the weapon, and of demonstrations on his part to test his practical ability in the subjects which have been covered. The questions are answered by the soldier in his own words.

Q. What is the name of the automatic rifle? A. The Browning automatic rifle, caliber .30, M1918A2.

Q. What type weapon is it? A. Shoulder weapon, gas operated, air cooled, magazine fed.

Q. How is the barrel cooled? A. There is no special cooling device. The barrel is exposed to the air.

Q. What is meant by gas operated? A. All of the functions of the automatic rifle, such as extraction and feeding,

are accomplished by a small portion of gas escaping through a port in the barrel and striking on a piston.

Q. How is the automatic rifle disassembled and assembled and what are the names of the parts? A. (Man being examined disassembles the rifle, names the parts as he lays them out in order from left to right, and then assembles the rifle.)

Q. How many rounds will the magazine hold? A. Twenty.

Q. What care must be taken of the magazines? A. They will be kept cleaned and well oiled. They will not be dented or bent.

Q. How are magazines filled? A. By using the magazine filler or by hand.

Q. How are the magazines changed in this rifle? A. (Man being examined demonstrates changing magazines.)

Q. Why should the accessory and spare parts kit be carried complete at all times? A. Because it contains equipment which is necessary to keep the rifle in action.

Q. How is the firing pin removed without disassembling the rifle? A. (Man being examined shows how it is done.)

Q. How is the extractor removed without disassembling the rifle? A. (Man being examined shows how it is done.)

Q. What is the first thing to do in case of any stoppage? A. Pull back and push forward the operating handle, tap the magazine, aim, and try to fire again.

Q. What is the next thing to do in case you have tried to fire again and the rifle still fails to fire? A. Remove the rifle from the shoulder and look in the ejection opening.

Q. What are the two main causes of the rifle firing a single shot after the first phase of immediate action has been applied? A. Insufficient gas and magazine trouble.

Q. What should always be done before firing to minimize stoppages? A. Inspect the magazines, properly adjust the gas cylinder, clean and oil the gas cylinder and operating parts, clean the chamber, and simulate firing two shots with the change lever set at the slow cyclic rate.

Q. What should be done during firing to minimize stoppages? A. Clean the chamber, note the force of ejection, oil the gas cylinder frequently, clean the gas cylinder, and oil operating parts.

Q. What usually causes failure to feed? A. Magazine trouble.

Q. How can you tell when the rifle is not getting enough gas? A. The rifle will fire but the bolt will not go to the rear.

Q. If your rifle is giving you trouble, due to failure to extract, what is probably the trouble? A. The chamber of the rifle has not been properly cleaned.

Q. What is this (drawing a circle on the ground or on paper)?—A. A circle.

Q. Where is the center of it? A. Here (pointing to the center).

Q. Suppose that circle represents a peep sight through which you are looking and that you are told to bring the top of the front sight to the center of it; where would the top of the front sight be? A. Here (pointing to the center of the circle).

Q. Make a mark in the circle to represent the front sight. Make a small silhouette to represent the target. Is the silhouette in the center of the peep sight? A. No; the center of the bottom edge of it is in the center of the peep sight.

Q. Why. A. Because the top of the front sight is in the center and just touches the bottom edge of the silhouette.

Q. Should the front sight be held up into the bottom of the silhouette? A. No; it just touches the bottom edge of the silhouette, so that all of the silhouette still can be seen clearly.

Q. What is this (indicating sighting bar)? A. Sighting bar.

Q. What is it for? A. To teach me how to aim.

Q. Why is it better than an automatic rifle for this purpose? A. Because the sights on it are much larger, and slight errors can be seen and pointed out more easily.

Q. What does this represent? A. The front sight.

Q. And this? A. The rear sight.

Q. What is this? A. The eyepiece.

Q. What is the eyepiece for? A. To cause me to place my eye in such a position as to see the sights in the same alignment as that set by the coach.

Q. Is there any eyepiece on the automatic rifle? A. No;

I learn by the sighting bar how the sights look when properly alined, and I must hold my head so as to see the sights the same way when aiming an automatic rifle.

Q. How do you hold your head steadily in this position when aiming an automatic rifle? A. By resting my cheek firmly against the stock.

Q. Where do you focus the eye when aiming the automatic rifle? A. On the front sight.

Q. What is wrong with the sight setting shown on this sighting bar? A. (The instructor now adjusts the sights of the bar, making various slight errors; first, to show the correct and incorrect adjustment of the sights, and then, with the sights properly adjusted, he sights on the small silhouette to demonstrate correct and incorrect adjustments, requiring the men to point out any errors.)

Q. Can you demonstrate the proper sight picture on the sighting bar? A. (The man being examined adjusts the movable rear sight and silhouette so that the sights are correctly alined on the target, and then hands it to the instructor for verification.)

Q. How do you hold the breath while aiming? A. I take in an ordinary breath and then let out a little; then, by closing the throat, hold the remainder while aiming and pressing the trigger.

Q. Take the prone position, aim, and simulate firing a shot at that mark. (The instructor must assure himself that the man knows how to hold his breath properly while aiming. Many men have great difficulty in learning to do this correctly.)

Q. What is the best position from which to fire the automatic rifle? A. The prone position, using the hinged butt plate and the bipod rest.

Q. Why is the sling used with the automatic rifle in the sitting and kneeling positions? A. To assist the firer in holding the rifle steady.

Q. What is wrong with these positions? A. (The instructor assumes the kneeling, sitting, and prone positions and has the man being examined point out errors, if any. The gun sling is properly adjusted in the sitting and kneeling positions.)

Q. How do you assume the firing positions for the automatic rifle? A. The man being examined then assumes the correct prone, sitting, kneeling, antiaircraft, and assault fire positions.

Q. How do you press the trigger in firing bursts at the slow cyclic rate? A. I press the trigger rapidly all the way to the rear with a constantly increasing pressure, applied by the independent action of the index finger, and hold the trigger all the way to the rear for the length of burst desired.

Q. What care must be taken, with reference to your sight alinement of the automatic rifle, after pressing the trigger? A. I must be careful to keep my sights alined correctly on the target from the time the bolt starts forward until the cartridge is fired.

Q. When firing bursts, are all shots aimed shots? A. No; the first shot of each burst is an aimed shot.

Q. How do you insure that each shot, after the first shot of the burst, hits the target? A. I insure that succeeding shots of the burst will hit the target by taking the correct position and holding the rifle steady throughout the burst.

Q. Is it necessary to take a long time in pressing the trigger? A. No; necessary rapidity is developed by practice in trigger manipulation exercises.

Q. How do you press the trigger in firing single shots? A. I press it quickly all the way to the rear and release it immediately.

Q. In firing several bursts, how do you gain time so as not to be compelled to hurry in aiming? A. I gain time by changing magazines rapidly and by keeping my eye on the target while firing.

Q. How does keeping your eye on the target help you to gain time? A. A man who looks away from his target loses time in finding his own target again.

Q. Now show me how you load a magazine into the receiver. A. (Soldier demonstrates.)

Q. How are the magazines changed while firing in the prone position? A. (Soldier demonstrates.)

Q. Is it important to get into the correct position before beginning to shoot? A. Yes; even though it takes more

time, I should always get into the correct position before beginning to shoot.

Q. What is meant by calling the shot? A. To say where you think the bullet hit in firing single shots and where the first round hit in firing bursts.

Q. How can you do this? A. By noticing exactly where the sights point when the single shot or the first round is fired.

Q. What is this (holding up a score book)? A. A score book.

Q. What are these numbers for (indicating the numbers above and below a represented target in the score book)? A. Vertical lines drawn through those numbers show the amount of change in windage (clicks) necessary to bring the next shot into the center of the silhouette.

Q. If you are firing at a range of 200 yards and a shot hits here (indicating), what change would you make on your sight to bring the next shot into the center of the silhouette? A. (Soldier explains.)

Q. What are these numbers for (indicating the numbers on the right and left of a represented target in the score book)? A. Horizontal lines through those numbers show the amount of change in elevation (clicks) necessary to bring the next shot into the center of the silhouette.

Q. What effect does moving the rear sight have on the shot? A. It moves it in the same direction as the rear sight moves.

Q. If you want to make a shot hit higher, what do you do? A. I increase my elevation.

Q. If you want to make your shots hit more to the right, what do you do? A. I move my rear sight to the right.

Q. If you move your rear sight one click of windage, how much will it move the strike of the bullet? A. Four inches for each 100 yards of range.

Q. If you change the elevation setting by one click, how much will it move the strike of the bullet? A. Four inches for each 100 yards of range.

Q. What sight changes would you make to cause the next shot to hit in the center of the target (the instructor places a spotter at some place other than the center of the full-sized

D target to represent a shot properly fired at 500 yards with zero windage and sights set at 500 yards)? A. (The man being examined makes the required sight changes, and the instructor verifies the sight setting.)

Q. What are the three principal uses of the score book? A. To show me where my shot group is located, to indicate how much change in the sight is necessary to move a shot or group of shots to the center of the target, and to make a record of the sight settings of my rifle for the different ranges under various conditions so that I will know the zero of my rifle.

Q. In firing at ranges up to and including 600 yards, what is the only weather condition for which you make sight corrections? A. Wind.

Q. What four things do you do in cleaning a rifle bore after it has been fired? A. I first remove the powder fouling from the bore. I then dry the bore thoroughly of the liquid used to remove the fouling. Then I inspect the bore, repeating the cleaning if necessary. Finally, I oil the bore.

Q. How do you remove powder fouling from the bore? A. by swabbing it thoroughly with patches saturated with bore cleaner; or, in the absence of bore cleaner, with soapy water, preferably warm.

Q. How do you dry the bore? A. By running clean patches through the bore until it is thoroughly dry.

Q. How do you protect the bore from rust? A. By swabbing it thoroughly with a cleaning patch dampened with oil.

Q. How should the metal parts of the rifle be oiled? A. The rifle should be oiled by placing a thin film of oil over all metal parts after cleaning.

Q. Why should the barrel not be removed from the breech and cleaned? A. It is very difficult to replace the barrel as tightly as it should be, and as soon as the barrel works loose the rifle will develop head space trouble.

c. As an essential part of this examination, the form shown in paragraph 57e will be completed by the platoon leader for each individual who is to fire.

SECTION III

COURSES TO BE FIRED

■ 81. SCOPE AND OBJECT OF RANGE PRACTICE.—*a.* Range practice is divided into two phases:

- (1) 1,000-inch range practice.
- (2) Known distance range practice.

b. In all range firing, the automatic rifle will be set for the slow cyclic rate.

c. Practice on the 1,000-inch range is included in all marksmanship courses to conserve time and troop labor during the range season. The 1,000-inch range provides a convenient, short-distance range whereon the soldier can receive training with service ammunition in the fundamentals of automatic rifle marksmanship. Firing on the 1,000-inch range will be included in instruction practice for every individual firing a qualification course. The amount of such firing within the limits set forth in the tables will be determined by the company or higher commander. In general, recruits will require more of this type of firing in their instruction than previously qualified men.

■ 82. SEQUENCE OF FIRING.—The instruction practice outlined for each course is intended to serve as a guide. Variations may be made in the sequence prescribed within instruction practice to take advantage of time, weather, and range facilities. Variations may be made in the sequence prescribed within record practice for the same reasons. In no case will an individual's record practice in a course be interspersed with his instruction practice.

■ 83. MARKSMANSHIP COURSES.—One of the following courses will be fired by each automatic rifleman. The conduct and rules governing these courses are covered in paragraphs 84 to 124, inclusive. The particular course to be fired will be designated by higher authority in accordance with the provisions of AR 775-10. In all exercises which require single shots, the magazine will be loaded with the five rounds necessary for the complete score.

a. Course A.—(1) 1,000-inch range.—(a) To zero the rifle.

TABLE I

Range (inches)	Time	Shots	Target (1,000-inch)	Position	Remarks
1,000	No limit	4	No. 1	Prone, bipod rest	Single shot.
1,000	do	3	No. 2	Sitting	Loop or hasty sling.
1,000	do	3	No. 3	Kneeling	Single shot. Do.

(b) Instruction practice.

TABLE II

Range (inches)	Time	Shots	Target (1,000-inch)	Position	Remarks
1,000	5 minutes	5	No. 1	Prone, bipod rest	Single shot.
1,000	do	5	No. 2	Sitting	Loop or hasty sling.
1,000	do	5	No. 3	Kneeling	Single shot. Do.
1,000	2 minutes 15 seconds.	40	No. 5 to No. 6.	Prone, bipod rest	Search and traverse, 8 magazines of 5 rounds, each in short bursts. ¹
1,000	1 minute 25 seconds.	40	No. 7 to No. 8.	do	Search and traverse, 2 magazines of 20 rounds, each in short bursts. ¹
1,000	20	15	No. 4	do	One magazine, 15 rounds, 5-round bursts.

¹ In bursts of 2 and 3 or 3 and 2 rounds.

(2) *Known distance range.—(a) Instruction practice.*

TABLE III

Range (yards)	Time	Shots	Target	Position	Remarks
200.....	No limit.	5	Rifle D.....	Prone, bipod rest.	Single shot.
200.....	do.....	5	do.....	Kneeling.....	Loop or hasty sling. Single shot.
300.....	do.....	5	do.....	Prone, bipod rest.	Single shot.
500.....	do.....	5	do.....	do.....	Do.

TABLE IV

Range (yards)	Time	Shots	Target	Position	Remarks
200.....	No limit.	5	Rifle D.....	Kneeling.....	Loop or hasty sling. Single Shot.
200.....	do.....	5	do.....	Prone, bipod rest.	1 magazine, 5 rounds, in short bursts.
300.....	do.....	5	do.....	do.....	1 magazine, 5 rounds, in short bursts.
500.....	do.....	5	do.....	do.....	Single shot.
500.....	do.....	10	do.....	do.....	1 magazine, 10 rounds, in short bursts.

TABLE V

Range (yards)	Time (seconds)	Shots	Target	Position	Remarks
200.....	No limit.	5	Rifle D.....	Kneeling.....	Loop or hasty sling. Single shot.
200.....	40.....	15	do.....	Prone, bipod rest.	3 magazines, 5 rounds each, in short bursts.
300.....	40.....	15	do.....	do.....	3 magazines, 5 rounds each, in short bursts.
500.....	No limit.	5	do.....	do.....	Single shot.
500.....	25.....	10	do.....	do.....	1 magazine, 10 rounds, in short bursts.

TABLE VI

Range (yards)	Time (seconds)	Shots	Target	Position	Remarks
200	40	15	Rifle D	Prone, bipod rest.	3 magazines, 5 rounds each, in short bursts.
300	40	15	do	do	3 magazines, 5 rounds each, in short bursts.
500	25	10	do	do	1 magazine, 10 rounds, in short bursts.

(b) Record practice.

TABLE VII

Range (yards)	Time (seconds)	Shots	Target	Position	Remarks
200	No limit	5	Rifle D	Prone, bipod rest.	Single shot.
200	40	15	do	do	3 magazines, 5 rounds each, in short bursts.
300	40	15	do	do	3 magazines, 5 rounds each, in short bursts.
500	No limit	5	do	do	Single shot.
500	25	10	do	do	1 magazine, 10 rounds, in short bursts.

*b. Course B.—(1) 1,000-inch range.—Fire tables I and II.
 (2) Known distance range.—(a) Instruction practice.*

TABLE VIII

Range (yards)	Time	Shots	Target	Position	Remarks
200	No limit	5	Rifle D	Prone, bipod rest.	Single shot.
200	do	5	do	Kneeling	Loop or hasty sling. Single shot.
300	do	5	do	Prone, bipod rest.	Single shot.

TABLE IX

Range (yards)	Time	Shots	Target	Position	Remarks
200.....	No limit..	5	Rifle D.....	Kneeling.....	Loop or hasty sling. Single shot.
200.....	do.....	5	do.....	Prone, bipod rest.	1 magazine, 5 rounds, in short bursts.
300.....	do.....	5	do.....	do.....	Do.

TABLE X

Range (yards)	Time (seconds)	Shots	Target	Position	Remarks
200.....	No limit..	5	Rifle D.....	Kneeling.....	Loop or hasty sling. Single shot.
200.....	40.....	15	do.....	Prone, bipod rest.	3 magazines, 5 rounds each, in short bursts.
300.....	40.....	15	do.....	do.....	Do.

TABLE XI

Range (yards)	Time (seconds)	Shots	Target	Position	Remarks
200.....	40.....	15	Rifle D.....	Prone, bipod rest.	3 magazines, 5 rounds each, in short bursts.
300.....	40.....	10	do.....	do.....	Do.

(b) *Record practice.*

TABLE XII

Range (yards)	Time (seconds)	Shots	Target	Position	Remarks
200.....	No limit..	5	Rifle D.....	Prone, bipod rest.	Single shot.
200.....	40.....	15	do.....	do.....	3 magazines, 5 rounds each, in short bursts.
300.....	40.....	15	do.....	do.....	Do.

c. Course C.—(1) 1,000-inch range.—Fire tables I and II.
 (2) Known distance range.—(a) Instruction practice.

TABLE XIII

Range (yards)	Time	Shots	Target	Position	Remarks
200.....	No limit..	5	Rifle D.....	Prone, bipod rest.	Single shot.
200.....	do.....	5	do.....	Kneeling.....	Loop or hasty sling. Single shot.

TABLE XIV

Range (yards)	Time	Shots	Target	Position	Remarks
200.....	No limit	5	Rifle D.....	Kneeling.....	Loop or hasty sling. Single shot.
200.....	do.....	5	do.....	Prone, bipod rest.	1 magazine, 5 rounds, in short bursts.

TABLE XV

Range (yards)	Time (seconds)	Shots	Target	Position	Remarks
200.....	No limit..	5	Rifle D.....	Kneeling.....	Loop or hasty sling. Single shot.
200.....	40.....	15	do.....	Prone, bipod rest.	3 magazines, 5 rounds each, in short bursts.

TABLE XVI

Range (yards)	Time (seconds)	Shots	Target	Position	Remarks
200.....	40.....	15	Rifle D.....	Prone, bipod rest.	3 magazines, 5 rounds each, in short bursts.

(b) *Record practice.*

TABLE XVII

Range (yards)	Time (seconds)	Shots	Target	Position	Remarks
200.....	No limit	5	Rifle D.....	Prone, bipod rest.	Single shot.
200.....	do.....	5	do.....	Kneeling.....	Loop or hasty sling. Single shot.
200.....	80.....	30	do.....	Prone, bipod rest.	6 magazines, 5 rounds each, in short bursts.

d. Course D.—1,000-inch range.—(1) Instruction practice.—Fire tables I and II and repeat table II.

(2) Record practice.—Fire table II.

e. Transition firing.—(1) This practice is conducted on field firing range according to the procedure explained below (see also par. 238). Tables I and II will be fired after record practice and prior to firing combat exercises.

TABLE I

Range (yards)	Time (seconds)	Shots	Target ¹	Position	Remarks
200.....	60.....	10.....	3 E silhouettes.....	Prone, bipod rest.	Bursts of 2 rounds.
300.....	60.....	10.....	do.....	do.....	Do.
500.....	60.....	10.....	do.....	do.....	Do.

¹ Targets should be approximately 5 yards apart and as near the prescribed range as the terrain admits.

TABLE II

Range ¹	Time (seconds)	Shots	Target	Position	Remarks
	120.....	20.....	6 E silhouettes.	Prone, bipod rest.	Bursts of 2 rounds.

¹ Two targets between ranges of 200 and 300 yards, two targets between 300 and 400 yards, and two between 400 and 500 yards. Each pair of targets will be staggered and separated in depth from 25 to 50 yards.

(2) Targets are fastened to sticks and operated by men protected in individual pits.

(3) Targets are exposed on signal of the officer in charge of firing. Targets are withdrawn individually when hit. Ricochets are counted as hits. No marking of targets is required, since a hit is scored when the target is withdrawn.

(4) The following method of scoring will be used:

(a) *Table I.*

For each target hit.....	1
For each two unexpended rounds, not exceeding four rounds, if all targets are hit.....	1

NOTE.—If an odd number of unexpended rounds remain, the next lower (even) number is used in computing the score.

(b) *Table II.*

For each target hit:	
Between 200 and 300 yards.....	1
Between 300 and 400 yards.....	2
Between 400 and 500 yards.....	3
For each two unexpended rounds, not exceeding eight rounds, if all targets are hit.....	3

NOTE.—If an odd number of unexpended rounds remain, the next lower (even) number is used in computing the score.

(5) Only one person will be assigned to a group of targets in each order. Prior to the start of the exercise, the automatic rifleman will be in the prone position with the bipod adjusted. The coach will set the sights off in elevation sufficient to require an adjustment of sights. When all is ready, the officer in charge of firing commands: **LOAD**. When the targets appear, the automatic rifleman will adjust his sights before commencing fire.

(6) Each automatic rifleman will fire tables I and II. Within prescribed ammunition allowances for qualification in arms, each automatic rifleman will refire table II until he fires a satisfactory score. The satisfactory score is 8.

SECTION IV

RANGE PRACTICE

■ 84. GENERAL.—*a. Training programs and schedules.*—Training programs and schedules will provide a period for range practice.

b. Range practice.—Range practice includes both 1,000-inch firing and known distance firing.

c. Officers' range practice.—The officers of an organization should be enabled to complete their own range practice in advance of their men whenever practicable in order that their entire attention may be given to their instructional duties.

d. Uniform.—The uniform to be worn during instruction practice and record practice will be prescribed by the commanding officer. The automatic rifleman's belt will be worn during instruction practice and record practice.

e. Use of pads.—The use of elbow pads is recommended. The use of shoulder pads is unnecessary but is permitted.

■ 85. ORGANIZATION.—The officers, noncommissioned officers, and coaches of the units on the range will perform duties generally similar to those prescribed for them in preparatory marksmanship instruction (par. 57).

a. Officer in charge of firing.—An officer in charge of firing will be designated by the responsible commander. This officer or his deputy will be present during all firing and will be in charge of the practice and safety precautions on the range.

b. Range officer.—A range officer with such commissioned and enlisted assistants as are necessary will be appointed by the post or station commander well in advance of range practice. At large camps or stations where the coordination of range practice for different organizations is involved, he may function as the direct representative of the camp or station commander. In other cases he is responsible to the officer in charge of firing and in all cases he cooperates closely with him. The range officer will make timely estimates for material and labor to place the range in proper condition for range practice, and will supervise and direct all necessary repairs to shelters, butts, targets, firing points, and telephone lines. He exercises direct supervision over

the practical operation of the rifle range during the practice season. He regulates the distribution of ranges and targets and in general assists the officer in charge of firing by using the means necessary to secure efficient and accurate service from the working force of the range. He provides safe conditions for the markers and any visitors. Whenever necessary he provides range guards and instructs them in the methods to be used for the protection of life and property in the danger area.

c. Unit range officers.—During the operation of any range by a unit the commanding officer thereof may detail an officer as unit range officer. The unit range officer will be responsible to the commanding officer of the organization to which the range is assigned for its efficient operation.

d. Pit detail.—An officer or noncommissioned officer with such assistants as may be necessary will be detailed in charge of arrangements in the pit. He will be responsible to the officer in charge of firing for the discipline, efficiency, and safety of all pit details. He sees that all of the target equipment is kept in serviceable condition; that the desired targets are ready for firing at the appointed time; and that all target details are provided with the proper flags, marking disks, paste, pasters, and spotters.

■ 86. USE OF DUMMY CARTRIDGES.—The corrugated type of dummy cartridges may be used in range practice. When ammunition must be conserved, a proportion of the corrugated type dummies may be included in magazines with live ammunition. The use of any other type of range dummies is prohibited.

■ 87. FIRING POINTS.—All firing points should have firm soil. Loose loam or sand on the firing point has an adverse effect on accuracy.

■ 88. COACHING.—*a. General.*—(1) During instruction practice, each man on the firing line will have a coach to watch him and to help him correct his errors. An average soldier who has been properly instructed in the preparatory work or who has been given instruction in coaching methods can be used with good results and is used when more experienced coaches are not available.

(2) It is good practice to have experienced coaches in charge of one or more targets, usually on a flank, to which pupils are sent for special coaching if required.

(3) Great patience should be exercised by the coach so as not to excite or confuse the firer. Everything is done to encourage him. It is often a good plan to change coaches. It is necessary to do so if the coach shows signs of impatience.

b. Position of coach.—The position of the coach is as outlined in paragraph 70.

c. Duties of coach.—The success of the instruction depends to a great extent on the thoroughness and exactness with which the coach performs his duties. Duties of the coach, in addition to those given in paragraph 59, are as follows:

(1) To insure that the firer has inspected his rifle for cleanliness, proper adjustment, and functioning.

(2) To check the sight setting.

(3) To observe the firer and see that he remains after each shot or burst.

(4) To require the firer to fire as required for each target.

(5) Point out errors and explain their effect.

(6) Keep constant watch on the adjustment and condition of the rifle.

(7) Keep constant watch to see that all safety measures are strictly carried out.

89. **TO ALINE FRONT SIGHT.**—*a.* The front sight will be adjusted only as directed by an officer. If the front sight is badly out of alinement, it should be adjusted at the first opportunity by a qualified soldier. This is done by tapping the front sight with a hammer and punch, then test firing, and repeating this procedure as many times as necessary to secure the proper sight alinement. Tapping the *front sight to the right* moves the strike of the next *bullet to the left*, and vice versa.

b. In this firing, the windage setting is set at 0 and the soldier aims at the bottom edge of a designated figure on the 1,000-inch target, United States rifle, caliber .30, M1. He fires two or more rounds very carefully, using exactly the same aiming point for all shots. The center of the resulting

shot group indicates how much and in what direction to move the front sight. The soldier then verifies the front sight adjustment by firing two more rounds.

c. If the shot group is to the right of the aiming point, move the front sight to the right; if to the left, move the front sight to the left. To move the strike of the bullet 1 inch at a range of 1,000 inches requires a movement of the front sight of only 0.025 inch.

■ 90. TO DETERMINE ZERO OF RIFLE.—Each rifle will be “zeroed” for the 1,000-inch range in the firing provided for that purpose in table I. Each rifle will be zeroed for 300 and 500 yards during the instruction practice provided for those ranges. Each man will keep a record of these zeroes in his score book. It will be noted that the lowest graduation on the rear sight leaf is 300 yards. When the rifle is fired at 200 yards with a sight setting of 300 yards, a shot will hit the target approximately 6 inches above the point of aim. However, since the dimensions of the silhouette of the D target are 26 inches wide and 19 inches high, a shot fired at 200 yards with a sight setting of 300 yards will be well within the silhouette.

a. *To zero rifle for 1,000-inch range.*—(1) When the automatic rifle is fired with the sights properly alined on the bottom edge of the silhouette and the resultant shot group is in the center of the silhouette, the rifle is zeroed.

(2) The first two or more rounds are fired at the black silhouette of figure 1 (see fig. 27) with the sight set at 400 yards and zero windage. If necessary, corrections in elevation and windage to bring subsequent shots into the center of the black silhouette are then made by turning the elevating and windage knobs. Such corrections are applied after every two or more shots under the direction of an instructor. If the visibility of the shot groups is limited, the instructor, after taking necessary safety precautions, may move along the line of targets and announce the corrections to the coaches in terms of clicks. Changing the elevation or windage one click moves the strike of the bullet on the target approximately 1 inch on the 1,000-inch range.

b. *To zero rifle for known-distance ranges.*—(1) *General.*—The position of the spotters on the target will permit the

necessary corrections in elevation and windage to be computed by the elevating and windage rules, or by use of the windage and elevation corrections shown in the score book. They are then applied as clicks to the sight. These sight settings should be made under the supervision of an instructor or experienced coach after groups of two or more rounds are fired.

(2) *At each range.*—Set the elevation at the desired range. Set the windage so as to allow for existing wind, or, if there is no wind, at zero. Fire two rounds, or more if necessary, single shot to obtain a shot group, and then apply corrections in clicks of elevation and windage to bring the center of the shot group into the center of the target. Record these corrections in the score book as the zero for that range.

■ 91. INSTRUCTION PRACTICE ON 1,000-INCH RANGE.—*a.* Instruction practice on the 1,000-inch range will conform to the regulations given in paragraphs 94 to 124, inclusive, for record practice except that coaching is permitted and additional personnel to score targets is not required.

b. Each exercise on the 1,000-inch range will be preceded by an appropriate fire order.

(1) The form of fire order for firing without time limit is as follows:

- (a) Announce the position.
- (b) ---- rounds single shot, with ball cartridges, LOAD.
- (c) Figure 1.
- (d) COMMENCE FIRING.
- (e) CEASE FIRING.
- (f) CLEAR RIFLE.

(2) For firing with time limit, the form of the fire order is as follows:

- (a) Announce the position, number of magazines, and number of rounds per magazine.
- (b) With ball cartridges, LOAD.
- (c) Figures 3 and 4. ---- rounds on each figure in ---- round bursts.
- (d) COMMENCE FIRING.
- (e) CEASE FIRING.
- (f) CLEAR RIFLE.

c. If the 1,000-inch range is equipped with pits and sliding targets similar to those of a known distance range, the fire orders for firing prescribed for the known distance range under paragraph 92 apply except that b(2)(c) above is substituted for paragraph 92b(2)(c).

■ 92. INSTRUCTION PRACTICE ON KNOWN DISTANCE RANGE.—a. Instruction practice is carried out in conformity with the regulations governing record practice as given in paragraphs 94 to 124, inclusive, except that additional personnel for scoring targets are not required and each firer will have a coach with him on the firing line. The officer in charge of firing may prescribe the sequence of firing the courses of instruction practice.

b. Each exercise on the known distance range will be preceded by an appropriate fire order.

(1) The form of fire order for firing without time limit is as follows:

(a) Announce the position and number of rounds to be fired.

(b) With ball cartridges, LOAD.

(c) Single shots.

(d) COMMENCE FIRING.

(e) CEASE FIRING.

(f) CLEAR RIFLE.

(2) For firing with time limit, the form of the fire order is as follows:

(a) Announce the position, number of magazines, and number of rounds per magazine.

(b) With ball cartridges, LOAD.

(c) ---- round bursts.

(d) Ready on the right?

(e) Ready on the left?

(f) READY ON THE FIRING LINE.

(g) CEASE FIRING.

(h) CLEAR RIFLE.

The targets are withdrawn before the exercise starts and the red flag displayed at the center target. The command READY ON THE FIRING LINE is transmitted to the officer or noncommissioned officer in charge in the pits who will have

the red flag waved and lowered on its receipt and who will cause the targets to be run up simultaneously 5 seconds after the flag is lowered. Upon the expiration of the proper time interval he causes the targets to be withdrawn. The officer in charge of the firing line gives the commands **CEASE FIRING** and **CLEAR RIFLE** when targets are withdrawn.

■ 93. **SAFETY PRECAUTIONS.**—For safety precautions to be observed in handling and firing the automatic rifle, see paragraph 241.

SECTION V

REGULATIONS GOVERNING RECORD PRACTICE

■ 94. **GENERAL.**—*a.* Record practice for course, A, B, or C is fired on the known distance range. Record practice for course D is fired on the 1,000-inch range. Additional provisions applicable to course D are given in paragraph 124.

b. Record practice will follow instruction practice.

c. When the record practice of an individual has commenced, it will be completed without interruption by any other form of firing. Instruction practice and record practice will not be conducted simultaneously unless the two types of practice are conducted on different parts of the range.

d. The officer in charge of firing may, at his discretion, require record practice upon the day on which instruction practice is completed.

e. When no additional compensation for qualification in arms is authorized, provided that ammunition allowances for qualification are not exceeded, an individual may be permitted to refire a qualification course until he has qualified.

■ 95. **FIRE ORDERS.**—Every time-fire exercise fired in record practice will be preceded by an appropriate fire order. Suitable forms for such orders are given in paragraphs 91 and 92.

■ 96. **SEQUENCE OF EXERCISES.**—The exercises given in the tables for record practice will be fired in the sequence directed by the officer in charge of firing.

■ 97. STOPPAGES.—*a.* When a stoppage occurs which cannot be cleared by the application of the first phase of immediate action, the firer will call "Time." The officer in charge of firing or one of his assistants will note the time left to complete the exercise, and will then investigate the stoppage. The stoppage will be reduced. If the stoppage was not due to any fault of the firer, he will be authorized to load, aim, and commence firing on command from the officer investigating the stoppage, who will allow him the unexpired time. In cases where the exact time remaining was not determined by the officer in charge, the firer will be allowed 2 seconds per round for the remaining rounds. When time and ammunition permit, the complete exercise will be refired.

b. If the stoppage is manifestly the fault of the firer in failing to inspect either the rifle, magazines, or ammunition, or is due to incorrect loading or replacing of magazines, no time will be allowed to complete the exercise and only that part of the exercise which was completed will be scored.

c. The firer will be allowed to fire rounds ejected in clearing stoppages.

d. The soldier firing will not be given any information with reference to the location of his previous hits on the incompleting target until the score is completed.

e. Should a breakage occur, the rifle will be repaired or a different rifle substituted and the exercise completed. If a different rifle is substituted, the firer will be allowed extra rounds to determine the zero of the substituted rifle.

f. The officer in charge or his assistants will render all decisions on stoppages.

g. A firer, firing part of a time-fire exercise, will begin his firing with the entire target exposed.

■ 98. MEN MARKING TARGETS NOT TO KNOW WHO IS FIRING.—Officers and men in the pit will not be informed as to who is firing on any particular target. In case of such violation, the firer will be required to repeat his score and appropriate disciplinary action taken.

■ 99. TARGET DETAILS.—When the keeping of pit score cards is *not* required the personnel necessary to execute properly the remaining functions of pit details as described below

will be specified by the local commander. When the keeping of pit score cards is required, the details for the supervision, operation, marking, and scoring of targets during record practice consist of officers, noncommissioned officers, and privates, as follows:

a. One commissioned officer assigned to each two targets. When it is impracticable to detail one officer to each two targets in the pit, an officer will be assigned to supervise the marking and scoring of not to exceed four targets. In this case the pit scores will be kept by the noncommissioned officer in charge of each target who will sign the score cards. The officer will take up and sign each score card as soon as the complete score is recorded.

b. One noncommissioned officer assigned to each target to direct and supervise the markers. This noncommissioned officer will be selected from an organization other than the one firing on the target which he supervises. If this is not possible the officer assigned to the target will exercise special care to insure correct scoring.

c. One or two privates assigned to operate and mark each target. These privates may be selected from the organization firing.

■ 100. ORGANIZATION OF FIRING LINE.—a. Scorers are seated in rear of and to the right of the person firing.

b. Telephone operators 5 paces in rear of the firing line.

c. Persons awaiting their turn to fire 10 paces in rear of the firing line.

d. Low arm racks or rifle racks and cleaning racks 20 paces in rear of the firing line.

■ 101. SCORE CARDS AND SCORING.—a. One score card will be kept at the firing point. An additional score card will be kept in the pits when firing is being conducted for additional compensation for arms qualification, except that, for the duration of the war, these pit score cards will *not* be required. However, local commanders may specify that pit score cards be kept. If both cards are required, they should be of different colors. The cards at the firing point will bear the date, the firer's name, the number of the target, and the order of firing; the pit card, when used, will not show the firer's

name but will bear the date, the number of the target, and the order of firing.

b. Entries on all score cards will be made in ink or with indelible pencil when firing is being conducted for compensation for qualification in arms. Also, under the same condition, no alteration or correction will be made on the card except by the organization commander or officer scorer in the pit, who will initial each alteration or correction made.

c. The scores at each firing point will be kept by a non-commissioned officer of some organization other than the organization firing on the target to which he is assigned; when no compensation for qualification in arms is authorized, selected privates or privates first class may act as scorers. If this is not possible, company officers will exercise special care to insure correct scoring. As soon as the score is completed, the score card will be signed by the scorer, taken up, and signed by the officer supervising the scoring. As soon after the day's firing as possible, the score cards are turned over to the organization commander. Except when required for entering new scores on the range, score cards will be retained in the personal possession of the organization commander.

d. In the pit, the officer keeps the scores for the targets to which he is assigned. As soon as a score is completed, he signs the score card. He turns these cards over to the organization commander at the end of the day's firing. They will be checked for accuracy with the firing point cards after the completion of each day's firing. The score kept at the firing point is the record score. All cases of discrepancy between the two record cards will be adjusted at the time they are discovered by the officer in charge of the firing point. (AR 345-1000.)

e. Upon completion of record firing and after the qualification order is issued, all score cards and reports of boards in his possession will be destroyed by the organization commander.

■ 102. MARKING.—a. The value of the shot is indicated as follows:

- (1) A five by a white disk.
- (2) A four by a red disk.

(3) A three by a white disk with a black cross.

(4) A two by a black disk.

(5) A miss by waving a red flag across the front of the target.

(6) Ricochet hits will be counted as a miss and so indicated.

b. Spotters are placed in shot holes before running the target up for marking.

c. The marking begins with the hits of the highest value. The center of the disk is placed over the spotter, then swung off the target and back again to the next spotter, care being taken each time to show the correct face of the disk. The marking must be slow enough to avoid confusing the scorer at the firing point. When one spotter covers more than one shot hole the disk is placed over it the required number of times. Misses are indicated by slowly waving the red flag across the face of the target one time for each miss.

■ 103. PROCEDURE IN FIRING WITHOUT TIME LIMIT.—*a. On the firing line.*—(1) One person only will be assigned to each target in each order.

(2) As the values of each shot are signaled, the scorer announces, in a tone sufficiently loud to be heard by the firer, the target number, the number of the shot, and the value of the hit. The scorer then records the value of the hits on the score card.

(3) In the event that more than one round is fired in an exercise calling for single shots, the number of rounds fired in the burst will be scored as though they were fired singly.

(4) Whenever a target is marked before the individual who is assigned thereto has fired, as will occur when another man fires on the wrong target, the scorer will notify the officer in charge of firing. The latter will notify the officer in the pit assigned to the target to disregard the shot. This precaution is necessary to prevent errors in the pit record. When pit score cards are *not* required, the provision of this paragraph may be amended by local commanders.

(5) When an individual fires on the wrong target, he will not be scored a miss until the target to which he is assigned has been pulled down and the miss signaled from the pit.

(6) If the target is not half masked at the completion of a score thereon, or if it is half masked at the wrong time, the

officer in charge of that firing point will adjust the matter at once over the telephone. This precaution is necessary to prevent the error from being carried through the scores that follow. When keeping of pit score cards is *not* required, the provisions of this paragraph will be disregarded.

b. In the pit.—(1) The target is withdrawn and marked after each shot.

(2) In the event that more than one round is fired in an exercise calling for single shots, the number of rounds fired in the burst will be marked as though they were fired singly.

(3) When a shot is fired at a target, it is pulled down. The noncommissioned officer indicates the location of the hit to the officer assigned to the target who announces its value and records it on the score card. A spotter is then placed in the shot hole, the previous shot hole, if any, is pasted, and the target is run up and marked. The noncommissioned officer supervises the marking of each shot; the officer exercises general supervision over the marking. When pit score cards are *not* required, the provisions of this paragraph may be amended by local commanders.

(4) When the pit score card indicates a score has been completed, the target is half masked for about 30 seconds as a signal to the firing line of such completion. At the end of the 30 seconds, the target is pulled fully down, the spotter removed, the shot hole pasted, and the target run up for the beginning of a new score. When the keeping of pit score cards is *not* required, the provisions of this paragraph will be disregarded.

(5) When a target frame is used as a counterweight for a double sliding target, the blank side of such frame will be toward the firing line.

■ 104. PROCEDURE FOR FIRING WITH TIME LIMIT.—*a. On the firing line.*—(1) One person only will be assigned to a target in each order.

(2) When all is ready in the pit, the red flag is displayed at the center target. At that signal, the officer in charge of the firing line will conduct the exercise to be fired in accordance with the procedure given in paragraph 92.

(3) If any individual fails to fire at all, he will be given another opportunity. If he fires one or more bursts, the score

must stand as his record except as provided in paragraph 97. He will not be permitted to repeat his score on the claim that he was not ready to fire.

(4) As each shot is signaled from the pits, it is announced by the scorer at the firing line. A score of 15 shots is announced as follows as each shot is disked: "Target 22; 1 five, 2 fives, 3 fives, 4 fives, 5 fives, 6 fives, 7 fives; 1 four, 2 fours, 3 fours, 4 fours, 5 fours, 6 fours, 7 fours; 1 two." The scorer notes these values on a pad and watches the target as he calls the shot. After disking is finished, he counts the number of shots, and if it is more or less than 15, calls "Redisk No. ----." If 15 shots have been disked, he then enters the value of each hit and their total value on the soldier's score card.

b. In the pit.—(1) The time allowed for each exercise is regulated by the officer in charge of the pit. The procedure is as follows: The targets are withdrawn before the exercise starts, and the red flag is displayed at the center target. The command **READY ON THE FIRING LINE** is transmitted to the officer or noncommissioned officer in charge in the pits who will have the red flag waved and lowered on its receipt and who will cause the targets to be run up simultaneously 5 seconds after the flag is lowered. The targets are fully exposed for the prescribed length of time, and upon the expiration of the proper time interval, he causes the targets to be withdrawn.

(2) The officers scoring in the pit examine each of their targets in turn, announce the score, and record it on the pit score cards. Spotters are then placed in the shot holes and the targets run up and marked. The noncommissioned officers supervise the marking of each shot; the officers exercise general supervision over the marking of their targets. When pit score cards are *not* required, the provision of this paragraph may be amended by local commanders.

(3) The targets are left up for about 1 minute after being marked. They are then withdrawn, pasted, and made ready for another score. They may be left up until ordered pasted by the officer in charge of the firing line. When the keeping of pit score cards is *not* required, the provisions of this paragraph may be disregarded.

(4) If more than the number of shots to be fired are found on any target in record practice, it will not be marked unless all of the hits are of the same value. The officer in charge of the firing line will be notified of the facts by telephone.

■ 105. USE OF TELEPHONES.—*a.* Telephones will be used for official communication only.

b. No one will ask over the telephone for information as to the name or organization of any person firing on any particular target, and no information of this nature will be transmitted.

c. The following expressions will be used over the telephone in the cases enumerated:

(1) When a shot has been fired and the target has not been withdrawn from the firing position, "Mark No. _____"

(2) When a shot has been fired and a target has been withdrawn from the firing position but not marked, "Disk No. _____"

(3) When the target has been withdrawn from the firing position and marked but the value of the shot has not been understood, "Redisk No. _____"

(4) When the firing line is ready for time fire, "Ready on the firing line."

(5) When a shot is marked on a target and the person assigned thereto has not fired, "Disregard the last shot on No. _____"

■ 106. COACHING PROHIBITED.—*a.* When additional compensation for qualification in arms is authorized, coaching of any nature after the firer takes his place on the firing line is prohibited. No person will render or attempt to render the firer any assistance whatever while he is taking his position or after he has taken his position at the firing line.

b. When no additional compensation for qualification in arms is authorized, coaching is permitted during record practice, with the following restrictions:

(1) The coach will not use any mechanical aid to assist the firer.

(2) The coach will not touch any part of the firer's body or rifle while the firer is sighting or firing.

■ 107. USE OF INSTRUMENTS.—*a.* The use of binoculars is authorized and encouraged.

b. The use of instruments or devices for determining the force and direction of the wind is prohibited during record practice.

■ 108. SHELTER FOR FIRER.—Sheds or shelter for the individual at the firing point will not be permitted at any range.

■ 109. RESTRICTIONS AS TO RIFLE.—Troops will use the Browning automatic rifle, caliber .30, M1918A2, as it is issued by the Ordnance Department. The use of additional appliances is prohibited. The sights may be blackened. Ordnance Department test equipment will not be used for determining the classification.

■ 110. AMMUNITION.—The ammunition used will be the service cartridge as issued by the Ordnance Department.

■ 111. CLEANING.—Cleaning is permitted at any time.

■ 112. GUN SLING.—The gun sling will be used as prescribed in this manual for the various positions and in no other manner.

■ 113. PADS AND GLOVES.—*a.* Pads of moderate size and thickness may be worn on both elbows to protect them from bruising. A smooth pad of moderate size and thickness may be worn on the right shoulder. The use of other forms of pads is prohibited. The use of a hook or ridge on the sleeve of the shooting coat or shirt to keep the sling in place on the arm is prohibited.

b. A glove may be worn on either hand provided it is not used to form an artificial support for the rifle.

■ 114. WARMING, FOULING, AND SIGHTING SHOTS.—No warming, fouling, or sighting shots will be allowed.

■ 115. SHOTS CUTTING EDGE OF SILHOUETTE OR LINE.—Any shot cutting the edge of the silhouette will be indicated and recorded as a hit in the silhouette. Because the limiting line of each division of the target is the outer edge of the line separating it from the exterior division, a shot touching

this line will be indicated and recorded as a hit in the higher division.

■ 116. SCORE INTERRUPTED.—If a score which is being fired without time limit is interrupted through no fault of the person firing, the unfired shots necessary to complete the score will be fired at the first opportunity.

■ 117. MISSES.—Before misses are signaled in record firing, the target will be withdrawn and carefully examined by an officer. Whenever a target is run up and a miss is indicated, it will be presumed that this examination has been thoroughly made. No challenge of the value indicated will be entertained or resignaling of the shot allowed.

■ 118. SHOTS TO BE INCLUDED IN SCORE.—All shots fired by the soldier in his proper turn after he has taken his place at the firing line and the target is ready will be considered as part of his score.

■ 119. FIRING ON WRONG TARGET.—Shots fired on the wrong targets will be recorded as misses on the score of the man firing, no matter what the value of the hits on the wrong target may be. The soldier at fault is credited with only such hits as he may have made on his own target.

■ 120. TWO SHOTS OF SAME TARGET.—If two shots strike a target at approximately the same time and were fired by one man, the firer is entitled to count the value of both shots. If two shots strike a target at the same time or nearly the same time and it is determined they were fired by different men, both will be disked. The individual who fired on his own target will be allowed the higher of the values of the two shots; the firer who fired on a target other than his own will be scored a miss.

■ 121. WITHDRAWING TARGET PREMATURELY.—If the target is withdrawn from the firing position just as a shot is fired, the scorer at that firing point will at once report the fact to the officer in charge of the scoring on that target. The officer will investigate to see if the case is as represented. Being satisfied that such is the case, he will direct that the shot be disregarded and that the man fire another shot.

■ 122. UNFIRED CARTRIDGES IN FIRING WITH TIME LIMIT.—Each unfired cartridge will be recorded as a miss, except as stated in paragraph 97.

■ 123. MORE SHOTS THAN PRESCRIBED IN FIRING WITH TIME LIMIT.—When target has more than the prescribed number of shots for a time-fire exercise in record practice and these hits are of different values, the target will not be marked. The soldier firing on that target will repeat the firing of his score. If all the hits on the target have the same value, the target will be marked and he will be given the value of the authorized number of shots.

■ 124. RECORD PRACTICE FOR COURSE D, 1,000-INCH RANGE.—*a.* The following special provisions apply only to record practice for course D which is fired on the 1,000-inch range.

b. So much of the foregoing provisions for record practice as can be applied will be followed. Suitable fire orders for use on the type of 1,000-inch range which is equipped with pits and movable targets, as well as suitable fire orders for use on the type of 1,000-inch range which is not so equipped, will be found in paragraph 91.

c. When the record practice is fired on 1,000-inch ranges not equipped with pits and movable targets the following rules will apply:

(1) Sufficient assistants will be detailed from companies other than the ones firing to assist the officer in charge. From the assistants, officers will be detailed as scorers at the rate of one for every four targets.

(2) The officers detailed as assistants will aid the officer in charge in every way possible. They will—

(*a*) Note deductions for penalties and report same to the scorer (see *e*(3) below).

(*b*) Note the time out for stoppages and inspect to determine whether the stoppage was due to any fault of the soldier.

(*c*) Superintend the firing of rounds remaining from stoppages not the fault of the firer.

(*d*) Scorers will count the bullet holes in each target and report any that have more than the prescribed number.

(*e*) Scorers will score the targets in accordance with the provisions of *e* below.

d. (1) When a stoppage occurs that cannot be cleared by the application of the first phase of immediate action, the firer will call "Time." The officer in charge of firing or an assistant will note the time left to complete the exercise. The stoppage will be reduced. The firer will load and complete the firing on command from the officer in charge who will allow the remaining time. In cases where the exact time remaining was not determined by the officer in charge, the firer will be allowed 2 seconds per round for the remaining rounds.

(2) If the stoppage is manifestly the fault of the firer, no time will be allowed to complete the exercise, and only that part of the exercise which was fired will be scored.

(3) Should a breakage occur, the rifle will be repaired or a different rifle substituted. If a different rifle is substituted, the firer will then be allowed extra rounds to determine the zero of the substituted rifle. He will then complete the exercise.

e. The 1,000-inch record target will be scored in accordance with the requirements for record firing as follows:

(1) The course shown in table II, paragraph 83a, will constitute the record course. The course consists of the six exercises shown in this table and includes a total of 110 shots.

(2) In all exercises the soldier will be credited with five points for hitting the scoring space included within or touching the outer scoring line of each figure at which he fires. In addition, he will be credited with one point for each shot placed in or touching this scoring space. Example: In the first exercise the soldier fires his five shots at figure No. 1 and scores five hits. He is credited with five points for hitting the scoring space and an additional point for each shot therein. His total score is ten points.

(3) In all of the exercises except the sixth, a total of 5 shots only per scoring space will be allowed. Additional shots placed in the scoring space will not be counted. In the sixth exercise, 15 shots will be fired on figure No. 4 in 5-round bursts. Hits in excess of 15 on target No. 4 will not be allowed.

(4) The total possible score for each exercise and for the record course is as follows:

Exercise:	Shots	Total possible score
First.....	5	10
Second.....	5	10
Third.....	5	10
Fourth.....	40	80
Fifth.....	40	80
Sixth.....	15	20
Total possible score.....		210

(5) For firing before COMMENCE FIRING or after CEASE FIRING, five points will be deducted for each round so fired.

(6) In case of hits on the wrong target, the firer who received the erroneous hits will refire his score. The firer who placed his hits on the wrong target will count those upon his own and will not be permitted to refire the exercise.

SECTION VI

TARGETS AND RANGES

■ 125. TARGETS.—The designations and dimensions of the two types of target used for marksmanship courses for the Browning automatic rifle, caliber .30, M1918A2, are as follows:

a. 1,000-inch target, United States rifle, caliber .30, M1 (fig. 27).—This target is used for fire on the 1,000-inch range. The scoring figures numbered from 1 to 8, inclusive, are utilized in known distance marksmanship (ch. 2). Each of these scoring figures is composed of three silhouettes. These silhouettes are reduced in scale to represent the appearance of target D on the known distance range. The inner silhouette of the 1,000-inch target represents the silhouette of target D at 500 yards; the middle silhouette represents the four space of target D at 300 yards; the outer silhouette target represents the four space of target D at 200 yards.

b. Target D.—This target is used for all types of fire on the known distance range. It consists essentially of a square target, 6 by 6 feet in dimensions, upon which a black silhou-

ette, representing a prone figure, is centered. Hits in the silhouette count 5, in the next space 4, and in the next 3. Hits on the remainder of the target count 2.

■ 126. RANGES.—*a. Suitability.*—Ranges suitable for range firing with the United States rifle, caliber .30, M1903 and M1, are equally suitable for range firing with the automatic rifle, caliber .30, M1918A2.

b. Installation and construction.—The installation and construction of target ranges for small arms target practice is governed by AR 30-1505. The installation of range communication systems is governed by AR 105-20. Range regulations for firing ammunition in time of peace are given in AR 750-10 and include the safety limits and danger areas of ranges.

c. Selection of known distance ranges.—(1) *Direction.*—If possible, a range should be so located that the firing is toward or slightly to the east of north. Such location gives a good light on the face of the targets during the greater part of the day. However, security and suitable ground are more important than direction.

(2) *Best ground.*—The targets should be on the same level with the firer or only slightly above him. Firing downhill should be avoided.

(3) *Size.*—The size of the range is determined by its plan and by the number of troops that will fire over it at a time. There are two general plans used in range construction: one with a single target pit and firing points for each range; the other with firing points on one continuous line, the target pits for the various ranges being in echelon.

(4) *Intervals between targets.*—The targets should be no farther apart than is necessary to reduce the chance of shots being fired on wrong targets. As a general rule, the intervals between targets are equal to the width of the targets themselves. Where the necessity exists for as many targets as possible in a limited space, this interval may be reduced one-half without materially affecting the value of the instruction.

(5) *Protection for markers.*—(a) Protection is provided for the pit details by excavating a pit, by constructing a parapet in front of them, or by a combination of both methods.

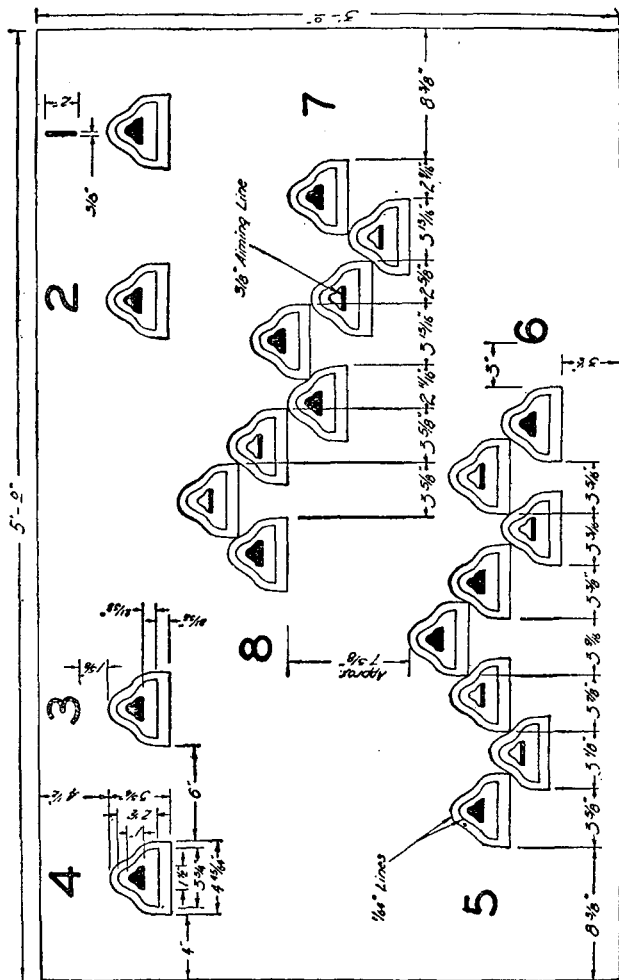

FIGURE 27.—Target, United States rifle, caliber .30, M1, 1,000-inch range.

(b) Where there are several targets in a row, the shelter should be continuous. It must be high enough to protect the markers. The parapet may be of earth with a timber or concrete revetment of sufficient thickness to stop bullets and from 7½ to 8 feet high above the ground or platform on which the markers stand.

(6) *Artificial butts.*—If an artificial butt is constructed as a bullet stop, it should be of earth not less than 30 feet high and with a slope of not less than 45°. The slopes should be sodded. The provisions of AR 750-10 must also be met by the range.

(7) *Hills as butts.*—A natural hill to form an effective butt should have a slope of not less than 45°.

(8) *Numbering of targets.*—Each target is designated by a number. The numbers for ranges up to 600 yards should be at least 6 feet in height and should be painted black on a white background. Arabic numerals of the size suggested will always be quickly recognized. They should be placed on the butt behind each target or on the parapet in front, and not so far above or below as to prevent the firer seeing the number when aiming at the target.

(9) *Measuring the range.*—The range should be carefully measured and marked with stakes at the firing points in front of each target. These stakes should be about 12 inches above the ground and painted white. Black figures indicate the number of the corresponding target.

(10) *Ranges parallel.*—The different ranges for the same distance should all be parallel so that similar conditions with respect to wind and light may exist.

(11) *Firing mounds.*—If it is necessary to raise a firing point, a low mound of earth no higher than required should be made. The mound should be level, sodded, and not less than 12 feet square. If the entire firing line is raised, the firing mound should be level, sodded, and not less than 12 feet wide on top.

(12) *Pit shed.*—A small house or shed should be built in or near the target pit for storing equipment.

(13) *Danger signals.*—A danger signal will be placed in front of the targets when firing has been suspended. One

or more red streamers will be prominently displayed on all ranges and at all times during firing.

(14) *Range house.*—On large ranges, a house containing a storeroom and office room is desirable.

(15) *Telephone service.*—Ranges should be equipped with a telephone system connecting the target pit with each firing point, the range house, and the station headquarters. The number of telephones should not be less than one to each 10 targets.

(16) *Electric bells.*—On large ranges the installation for each five targets of an electric bell that can be controlled from a central point in the pit adds materially to the celerity and uniformity of target manipulation for time fire.

(17) *Covered ways between pits.*—Where the pits are in echelon, covered ways or tunnels should be provided between the various pits. This construction will allow the pit details to be shifted with safety without interrupting the firing.

(18) *1,000-inch range.*—A 1,000-inch range without a land danger area behind its backstop must meet the following minimum requirements:

(a) Vertical bulletproof backstop and wing walls (natural or artificial) not less than 30 feet high. Wing walls must cover at least 15° on each flank. In case of artificial wing walls, they should be set at an angle of 15° with the backstop toward the firing points.

(b) Ricochet pit in front of firing points providing at least a 4° slope downward from the normal line of fire from a prone position and extending to within 30 feet of the backstop and wing walls. If a vertical cliff or wall over 40 feet high is available, no ricochet pit need be provided.

CHAPTER 3

MARKSMANSHIP, MOVING GROUND TARGETS

	Paragraphs
SECTION I. General	127-128
II. Moving vehicles	129-131
III. Moving personnel	132-133
IV. Moving targets, ranges, and range precautions ..	134-135

SECTION I

GENERAL

■ 127. **EMPLOYMENT.**—Automatic riflemen will be trained to fire at moving ground targets such as tanks, armored vehicles, trucks, and personnel. For tactical employment, see FM 7-10.

■ 128. **FUNDAMENTALS.**—The fundamentals of shooting as presented in paragraphs 52 to 93, inclusive, apply to firing at moving targets. In applying these fundamentals, the automatic rifleman must adjust his aim and trigger press to the movement of the target. According to the individual ability of the automatic rifleman, he should fire as long a burst as he can control and still secure reasonable accuracy. If the angular traverse of the moving ground target is such that the automatic rifleman can lead it while in the prone position, he does so by moving his shoulders. If the angular traverse is too great to permit leading the target while in the prone position, the automatic rifleman then assumes the antiaircraft position or a modified antiaircraft position and fires bursts as described above.

a. Effective range.—Training in the technique of fire at moving ground targets is normally limited to ranges of 500 yards or less; however, on proper occasions such fire may be delivered at longer ranges with effect comparable to that obtained by the light machine gun.

b. Sights to be used.—Moving ground targets are seldom exposed for long periods and can be expected to move at maximum speed during periods of exposure. Accurate cor-

rection of sight setting is often impracticable; therefore, instruction in technique should favor the use of the battle sight (300 yards). Corrections for range are made by adjustment of the aiming point on the target. In either case, correct estimation of the range is necessary.

c. Leads.—Targets which cross the line of sight at any angle are classified as crossing targets. In firing at such targets, the firer must aim ahead of the target so that the paths of the target and bullet will meet. The distance ahead of the target is called the "lead." Targets which approach directly toward the firer or recede directly from the firer will, for all practical purposes, require no lead.

SECTION II

MOVING VEHICLES

■ 129. DETERMINATION AND APPLICATION OF LEADS.—*a.* The lead necessary to hit a moving vehicle is dependent upon the speed of the target, the range to the target, and the direction of movement with respect to the line of sight. A vehicle moving at 15 miles an hour will traverse approximately 7 yards in 1 second. A rifle bullet moves 300 yards in about 0.4 second and 500 yards in about 0.7 second. Therefore, to hit a vehicle moving at 15 miles an hour at ranges of 300 yards and 500 yards, the leads should be 3 yards and 5 yards, respectively.

b. Leads are applied by using the length of the target (as it appears to the firer) as the unit of measure. This eliminates the necessity for corrections due to the angle at which the target crosses the line of sight, because the more acute the angle the smaller the target appears and the less lateral speed it attains.

c. The following lead table is furnished as a guide:

TARGET LENGTHS

Miles per hour	300 yards	500 yards
15	$\frac{1}{2}$	1

■ 130. **TECHNIQUE OF FIRE.**—The following technique is suggested for firing at rapidly moving targets, using the battle sight.

a. Approaching or receding targets.—The firer holds his aim directly on the target and presses off single shots or short bursts.

b. Crossing targets.—(1) At ranges less than 300 yards, the firer alines his sights on the bottom of the target, swings the point of aim laterally in the direction the target is moving, and takes the estimated lead. The automatic rifle is moved with the required lead and the shot is pressed off while the rifle is carried on with a follow-through swing.

(2) At ranges of more than 300 yards, the firer proceeds as in (1) above, except that he swings his point of aim across the top of the target.

c. Fire is executed as rapidly as proper aiming will permit.

d. When no other facilities are available, practice in taking aim and leads may be obtained by tracking vehicles engaged in normal traffic along roads near the training area.

■ 131. **PLACE IN TRAINING.**—The technique of firing at moving vehicles with live ammunition properly follows individual training in known distance firing, and should be preceded by instruction in range estimation. When time and ammunition allowances permit, caliber .22, followed by caliber .30, firing on the 1,000-inch range may be added as preliminary instruction.

SECTION III

MOVING PERSONNEL

■ 132. **TECHNIQUE.**—*a. Sight to be used.*—Under field conditions, moving personnel presents a fleeting target which is more difficult to hit than a moving vehicle. This fact increases the importance of an accurate sight setting. However, when targets appear suddenly, allowing no time for sight adjustment, the use of the battle sight may be required. It is therefore desirable that the automatic rifleman be trained in the employment of both types of firing.

b. Method of aiming.—(1) *Hold off.*—This method is used in aiming the automatic rifle for proper elevation using the battle sight. When firing at a man at a range of—

(a) 300 yards or less, aim at the middle of the body.

(b) More than 300 yards, aim at the top of his head (fig. 28).

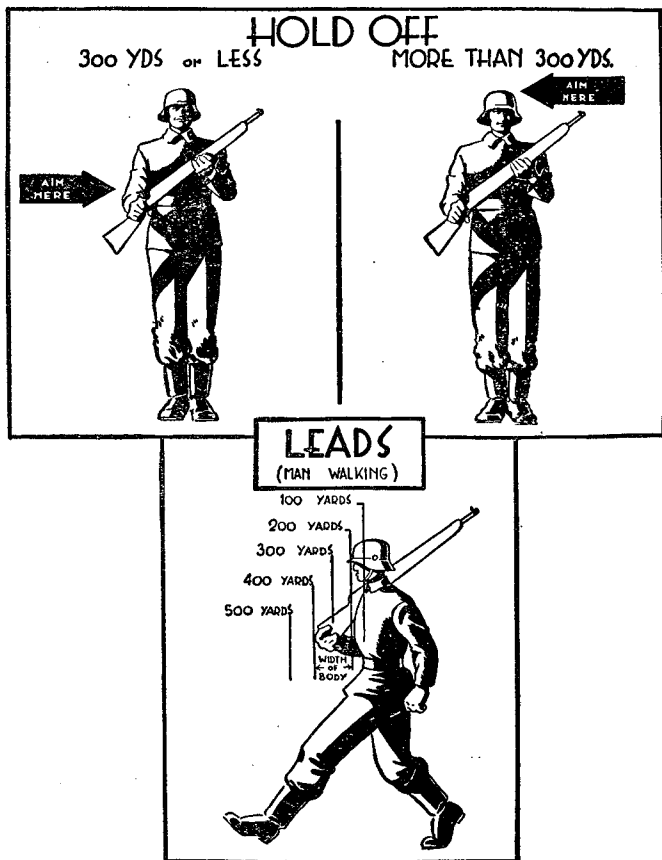

FIGURE 28.—Hold-off and leads for use against enemy personnel, using battle sight (300 yards).

(2) *Leading*.—To fire at a man walking across the front, aim as follows (fig. 28):

(a) At 100 yards, aim at forward half of the body.

(b) At 200 yards, aim at the forward edge of the body.

(c) At 300 yards, lead equals one-half of the width of the body.

(d) At 400 yards, lead equals the width of the body.

(3) Proficiency in this type of firing depends largely upon the amount of time devoted by the individual to the practice of aiming, pressing the trigger, leading with appropriate speed, and "following through."

c. *Size of burst*.—At moving personnel, the firing of shots is regulated by the proximity of the hostile group and the size of the group. As a general rule, at ranges of 300 yards and beyond, use single or double shots carefully aimed; at 200 yards, use bursts of 2 to 4 rounds; and at 100 yards against mass assaults, use larger bursts, even up to 10 or more rounds.

■ 133. WHEN TO CONDUCT TRAINING.—Like practice in firing at moving vehicles, training in firing on moving personnel follows instructions in known distance firing and should be preceded by instruction in range estimation.

SECTION IV

MOVING TARGETS, RANGES, AND RANGE PRECAUTIONS

■ 134. MOVING TARGETS AND RANGES.—a. *Firing at moving vehicles*.—(1) *Target*.—A sled of the type shown in figure 29① has proved to be the most satisfactory kind of target. It has the advantage of a low center of gravity, which prevents the target from upsetting when traversing rough ground or making changes of direction. The sled shown in the figure is 5½ by 3½ by 4½ feet high and weighs only 45 pounds. Figure 29② shows a similar sled covered with target cloth.

(2) *Towing*.—For towing the target, a ½-inch rope has been found satisfactory, the power being furnished by a 1½-ton truck. The pulley must be on an iron shaft

(threaded at one end to permit bolting) imbedded in concrete which is sunk in the ground. The concrete block is placed at a point where a change in direction of the target is desired. The knot shown in the figure should be 10 or 12 feet from the sled, depending on the speed at which the

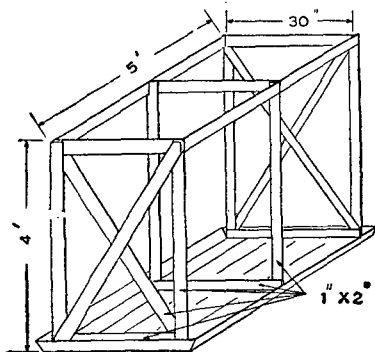

TARGET FRAME

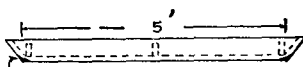

EDGE COVERED WITH SHEET METAL

ELEVATION OF BASE

① Target frame for moving-target range.

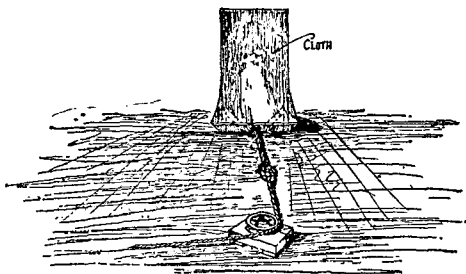

② Sled target covered with target cloth; pulley and trip knot for effecting changes of direction.

FIGURE 29.—Ground-towed target.

target is to be run. At faster speeds, the knot must be at a greater distance from the sled to prevent the latter from overrunning the pulley.

(3) *Set-up.*—With 500 yards of rope, a set-up as shown in figure 30 can be made. This set-up is only one of many which can be made with 500 yards of rope.

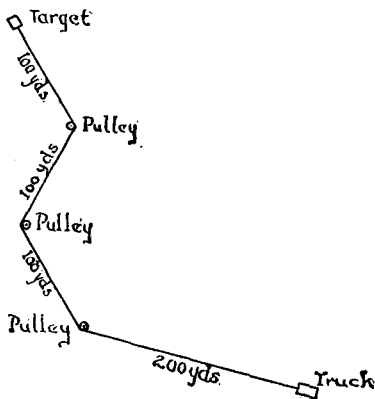

GUN

FIGURE 30.—Set-up for towing a target.

b. *Firing at moving personnel.*—Any class A range is suitable for firing at moving personnel. E targets on sticks carried by men walking or running in the pits are sufficient.

■ 135. RANGE PRECAUTIONS.—For general range precautions, see paragraph 241.

CHAPTER 4

MARKSMANSHIP, AERIAL TARGETS

	Paragraphs
SECTION I. Nature of aerial targets for automatic rifles.....	136-137
II. Technique of fire.....	138-142
III. Marksmanship training.....	143-147
IV. Miniature range practice.....	148-151
V. Towed target and radio-controlled plane target firing.....	152-156
VI. Ranges, targets, and equipment.....	157-162

SECTION I

NATURE OF AERIAL TARGETS FOR AUTOMATIC RIFLES

■ 136. **AERIAL TARGETS SUITABLE FOR AUTOMATIC RIFLE FIRE.**—Combat arms take the necessary measures for their own immediate protection against low-flying hostile aircraft and descending parachutists. Therefore, all troops must be fully trained and imbued with the determination to protect themselves against hostile aerial attacks without reliance upon other arms. All low-flying hostile aircraft and descending parachutists are suitable targets for automatic rifle fire.

■ 137. **CLASSIFICATION OF AERIAL TARGETS.**—*a. Overhead.*—Overhead targets are those which pass directly over or nearly over the firer.

b. Nonoverhead.—Nonoverhead targets are those which do not pass directly over or nearly over the firer.

NOTE.—Either of these types may be flying at a constant altitude or may be either increasing or decreasing in altitude.

c. Direct diving.—Direct diving targets are those which dive directly toward the firer.

d. Direct climbing.—Direct climbing targets are those which climb directly away from the firer.

SECTION II

TECHNIQUE OF FIRE

■ 138. **GENERAL.**—When concealment is essential and is believed to have been achieved, no weapons fire at hostile

aircraft. When concealment is not essential or obviously does not exist, all men armed with automatic rifles open fire as soon as attacking aircraft are within effective range. Such targets usually remain in view only for short periods of time. Therefore, they must be engaged promptly. Automatic riflemen must be taught a simple method of firing on hostile low-flying aircraft. This section on the technique of fire deals entirely with actual fire on hostile planes and gliders. Details of antiaircraft marksmanship training are contained in sections III, IV, and V.

■ 139. LEADS.—*a. General.*—In order to hit a target, such as an airplane in flight, it is necessary to aim an appropriate distance ahead of it and on its projected path of flight so that the target and the bullet will meet. This distance ahead of the airplane is called "lead." A lead must be applied in all firing except when the target is at extremely close range (100 feet), when it is diving directly at the firer, or is flying directly from him. The process of leading a target is called "tracking."

b. Determination of leads.—(1) The lead necessary to engage any target depends upon—

- (a) The speed of the target.
- (b) The range to the target.
- (c) The time required for the bullet to hit the target (time of flight).
- (d) The direction in which the target is moving with respect to the line of fire.

(2) When a target appears, it is impossible for automatic riflemen or leaders of rifle units to consider all of the factors contained in (1) above and compute accurately the lead required.

c. Application of leads.—The unit of measure for leading an airplane is one length of the plane—one target length. The number of leads to be used against planes which normally attack ground troops is six leads. The six target-length lead is the estimated average number of leads required to hit a 35-foot plane traveling at 300 miles per hour at ranges between 600 yards (maximum range at which ground troops fire at planes) and point blank range. The plane being visible to the firer, one target length can be applied quickly as

a unit of measure; and when a plane flies at an angle other than directly across the firer's front, the length of the target is foreshortened, as seen by the firer, in about the same proportion as its lateral rate of movement across the front is diminished. This last feature of the "target length" system of applying leads results in an automatic correction for different angles of flight across the front. A lead of six target lengths is used because the range to a flying plane changes so rapidly that a corresponding change in the number of leads is impracticable and, therefore, the estimated average number of leads required to hit a plane traveling at 300 miles per hour at ranges between 600 yards and point blank range is used. For faster or slower planes, the six target length lead is proportionately increased or decreased. The number of leads to be used, based on experience for a particular type of enemy plane, may be prescribed as Standing Operating Procedure, or it may be announced in a fire order.

■ 140. MASSING OF FIRE.—*a.* More effective results are obtained by massing the fire of a squad or platoon on a single target. When planes are flying in formation, Standing Operating Procedure should require that the fire of the squad or platoon be concentrated on the leading plane. The leader of the flight is the most important and the sight of tracers going into his plane tends to cause the following planes to turn away. For this reason, when no question of disclosing positions is involved, the use of tracer ammunition for anti-aircraft missions is desirable. Absolute accuracy in anti-aircraft fire is impossible; but if the maximum volume of fire consistent with accuracy is delivered, hits will be secured. According to the individual ability of the automatic rifleman, he should fire as long a burst as he can control and still secure reasonable accuracy. Fire should be opened at the command or signal of the platoon or squad leader. It should be directed only at recognized enemy planes; if planes cannot be identified as hostile, they will not be fired upon until they open fire or take other aggressive action.

b. The normal assignment of a target extends from its initial appearance until it passes beyond range. If there is a succession of groups of hostile airplanes or gliders, the leader will cause his unit to cease firing at one group in time to

bring fire on the following groups as they approach within effective range. However, consideration should be given to the fact that the dive bomber, just after dropping its bombs and leveling off to escape, is most vulnerable to fire from the rear.

■ 141. FIRE DISTRIBUTION.—*a.* The fire of rifle units will be distributed along the path of flight of the target as long as the target is within effective range when leads are applied as follows:

(1) For all targets except parachutists and direct diving or direct climbing aircraft, use the method prescribed in paragraph 139c.

(2) For all direct diving or direct climbing targets, aim and fire each burst at the target.

(3) Against parachute targets, aim and fire each burst with one target length lead.

b. The above methods of fire distribution are based upon the fact that, as the target is approaching or receding, the range and the leads are constantly changing and the target is engaged with a constant sight setting. The lead used for aircraft is the average for all leads necessary to engage a target between the extreme effective range of 600 yards and point blank range. The parachute target lead is based on an average of all leads necessary to engage such targets at ranges from 500 to 100 yards.

c. The target considered in determining the lead of six target lengths is a 35-foot airplane flying at 300 miles per hour. In towed target firing, the same number of leads is applicable, since the towed sleeve is 15 feet long and its average speed is 140 miles per hour.

d. Other methods of fire distribution may be used by unit commanders in training their units.

■ 142. DELIVERY OF FIRE.—*a. Range.*—The maximum effective range of rifle fire at airplanes (gliders) is approximately 600 yards, and 500 yards for parachutists. However, riflemen should take the firing position as soon as possible after receiving warning of the approach of hostile aircraft and track the target until it comes within range.

b. Rate of fire.—The rate of fire at aerial targets is about the same as the rapid fire rate at ground targets. Everything must be done to increase the rate of fire without affecting its accuracy. Repeated tests have proved that automatic rifle fire, delivered faster than is consistent with proper aim and trigger press, results in waste of ammunition. Each burst must be aimed and the trigger properly pressed. A well-trained automatic rifleman can fire a short burst every 3 seconds. A faster rate should not be permitted.

c. Sight used.—No attempt should be made to use the peep sight when firing at airplanes. Instead, the sight leaf is put down and the battle sight is used. When firing at parachutists, the peep sight is used. When firing on miniature ranges with caliber .22 rifles equipped with Lyman receiver sights, the peep sight should be unscrewed and removed so that the large opening which remains may be used in lieu of the peep sight.

d. Effect of caliber .30 fire on the airplane.—(1) There are various degrees of possible damage to an airplane from automatic rifle fire. Hits upon the cylinder wall and other important working parts are likely to stop an engine immediately. A hit through the metal propeller is also serious since it throws the engine out of balance. Unless the bombs carried by the airplane are bullet-proof, hits by armor-piercing small-arms bullets will detonate them. Of course the pilot is especially vulnerable. When tracer bullets penetrate the gasoline tank before the tracer composition ceases burning, the gasoline will be ignited instantaneously. When ball or armor-piercing bullets penetrate non-self-sealing gasoline tanks, they will cause gasoline leakage, which frequently also will be ignited by engine exhaust.

(2) There are also many lesser ways in which automatic rifle fire can damage an airplane. Holes through the crankcase may cause the oil to drain out, which will in turn cause the engine to "freeze" before the airplane returns to friendly territory. Hits of any kind require varying degrees of repair, even if they do not cause the destruction of the airplane. Finally, if the enemy knows he will receive effective small-arms fire from our troops, he will tend to avoid such fire, thereby decreasing the effectiveness of his action.

SECTION III

MARKSMANSHIP TRAINING

■ 143. INSTRUCTION.—*a. Object.*—(1) The object of anti-aircraft marksmanship instruction is to train the automatic rifleman in the technique of firing at rapidly moving aerial targets.

(2) Automatic rifle anti-aircraft marksmanship training should be given to the automatic rifle team in conjunction with the anti-aircraft marksmanship training given to the riflemen of the squad.

b. Basis.—(1) Prior to instruction in automatic rifle anti-aircraft marksmanship, automatic rifle teams should complete a course of training in automatic rifle marksmanship and thereby acquire the fundamentals of good shooting. To become a good anti-aircraft marksman, the firer must be able to apply the fundamentals of automatic rifle marksmanship to firing at rapidly moving targets and must be able to perform the following operations with accuracy and precision:

(a) Apply the required lead by using the length of the target as a unit of measure.

(b) Aline the sights of the automatic rifle, with the required lead, rapidly.

(c) Swing the automatic rifle with a smooth, uniform motion so as to maintain the aim at the required lead while getting off the burst.

(d) Apply correct trigger press so as to fire in a minimum of time without disturbing the aim.

(e) Follow through after the short burst is fired.

(2) The correct performance of the foregoing operations combined into one continuous, smooth motion when firing in any direction at rapidly moving aerial targets is the basis for the course of training outlined herein.

c. Sequence of training.—Since the automatic rifle team should receive its anti-aircraft training in conjunction with the riflemen of the squad (*a* above), the sequence of training is as follows:

(1) Preparatory exercises using the automatic rifle.

(2) Miniature range practice with the caliber .22 rifle.

(3) Miniature range practice with the automatic rifle, if ammunition allowances and range facilities permit.

(4) Firing at towed flag, towed sleeve, and radio-controlled plane targets when this firing is done by the rifle platoon.

d. Personnel to receive training.—All members of the automatic rifle team should receive automatic rifle-antiaircraft marksmanship training consistent with available time and ammunition allowance.

■ 144. PREPARATORY EXERCISES.—*a. General.*—(1) *Description.*—The preparatory exercises are designed to teach the soldier the correct method of performing each of the operations listed in paragraph 143*b*(1), and to drill him therein until the correct procedure becomes a fixed habit. In addition to a brief explanation of the technique of antiaircraft fire, the preparatory exercises consist of the following three distinct steps which should be completed on each of the targets described in *c* below, prior to firing:

(a) Position exercise.

(b) Aiming and leading exercise.

(c) Trigger-press exercise.

(2) *Methods.*—A conference by the instructor should precede each exercise. This conference should include an explanation of the necessity of the exercise and demonstrations by the instructor and a qualified squad. In order to awaken interest and to stimulate the soldier's enthusiasm, the preliminary instruction should be conducted individually and should be thorough. Each man should understand and be able to explain each point.

(3) *Coaching.*—During all preparatory exercises and miniature range firing, when a man is in a firing position he should have a coach whose duty is to watch him and to point out his errors. For this purpose, the soldiers should be grouped in pairs and take turns in acting as coach and pupil (fig. 31). Unit leaders are the instructors and should supervise and prompt the coaches.

b. Organization.—With the targets described in *c* below, and the target range described in paragraph 158, a group of 32 men (fig. 31) per target is the most economical training unit. For the preparatory exercises this will permit 16 men to perform the exercises on each type of target while

the remaining 16 men act as coaches. The automatic rifleman uses the automatic rifle in these exercises, while the riflemen use rifles. Each group should complete all preparatory exercises and instruction firing on one type of target on the miniature range before preparatory training and in-

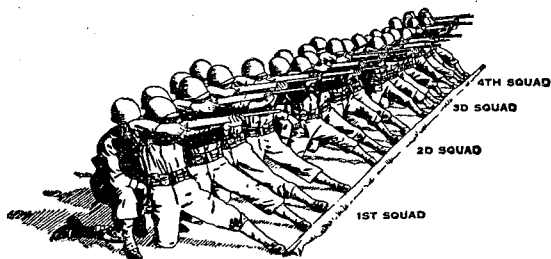

① Nonoverhead and parachute targets.

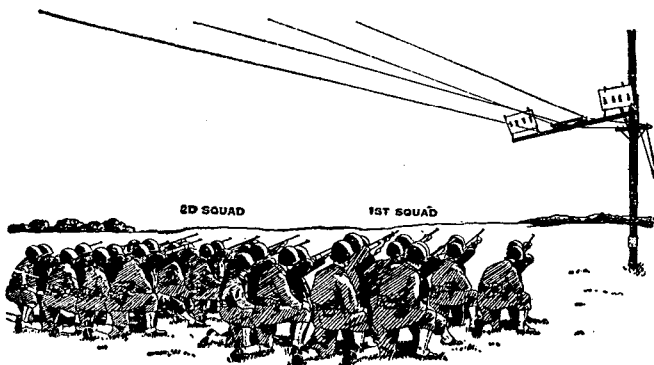

② Overhead targets.

FIGURE 31.—Organization for miniature range training.

struction firing is undertaken on the next type of target (par. 150). Groups change places as they complete the exercises on the targets assigned them. This procedure should be followed until each man of each group has completed his instruction, respectively, on the horizontal, climbing and diving, overhead, and parachute targets.

c. *Targets used on 500-inch miniature range in preparatory exercises and during firing both with caliber .22 and caliber .30 automatic rifles.*—(1) *Nonoverhead aiming and leading targets* (fig. 32).—Nonoverhead aiming and leading targets represent two towed sleeve targets (silhouettes). When moved at a rate of approximately 15 feet per second *horizontally* on the nonoverhead carrier, they represent targets being towed directly across the front; when moved *diagonally upward and downward*, respectively, on the climbing and

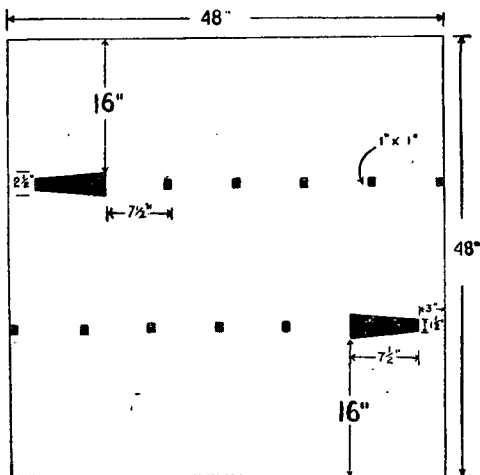

FIGURE 32.—Nonoverhead aiming and leading target.

diving target carrier, they represent targets in front of the firers which are climbing or diving, depending upon the direction of movement.

(2) *Overhead aiming and leading targets.*—Overhead aiming and leading targets represent four towed sleeve targets (silhouettes) approaching or moving away from the firer at a constant elevation (altitude). These targets also are moved at a rate of approximately 15 feet per second (fig. 33). The frames are placed on the carrier so that one set of silhouettes represents an approaching target and the other

set, a receding target. Additional silhouettes may be added if it becomes necessary to instruct more men.

NOTE.—Both the nonoverhead and the overhead aiming and leading targets represent targets being towed at approximately 245 miles an hour. The nonoverhead targets, being placed at 500 inches from the firer, represent targets at 330 yards range; overhead targets approaching the firer similarly are placed initially at 500 inches, representing a range of 330 yards, gradually thereafter decreasing to zero range when directly overhead. The speed at which the nonoverhead target carrier drum must be turned so that the silhouette will travel its own length during the time required for the flight of the bullet should be determined for each range by actual experiment.

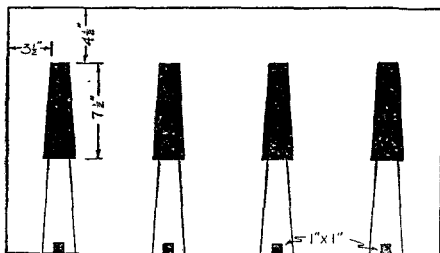

FIGURE 33.—Overhead aiming and leading target.

(3) *Parachute aiming and leading target.*—Parachute aiming and leading targets (fig. 34) represent four descending

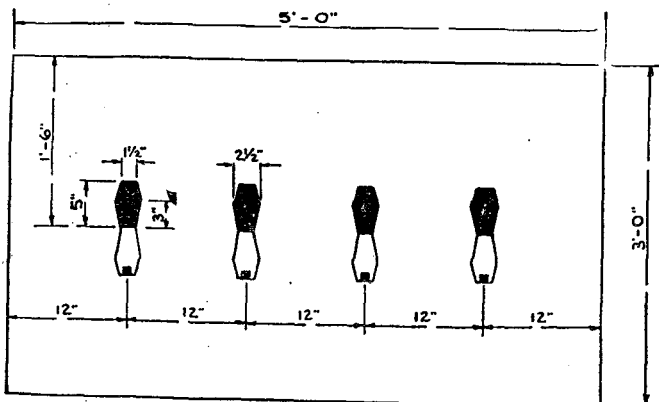

FIGURE 34.—Parachute aiming and leading target.

parachute targets (silhouettes) which should operate at a rate of 1 foot per second. Under this condition, these targets represent actual parachutists at 300 yards descending at 17 feet per second.

NOTE.—Nonoverhead aiming and leading targets are provided with several black squares (pasters) which are used as aiming points for announced leads. Overhead and parachute targets are also provided with one similar square (paster) used for the same purpose.

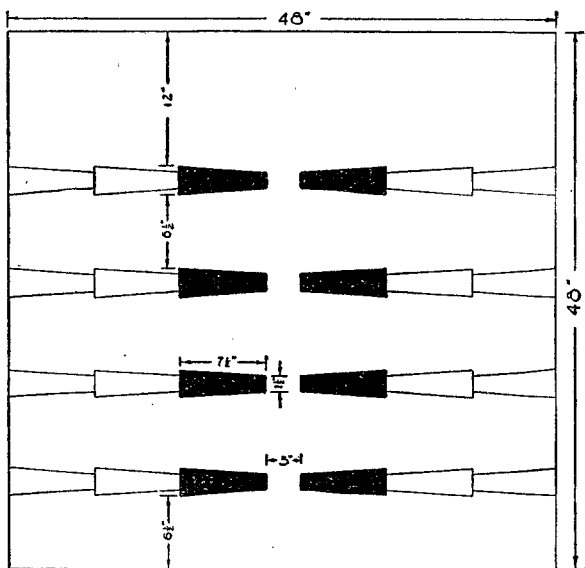

FIGURE 35.—Nonoverhead instruction target.

(4) *Trigger-press targets.*—Trigger-press targets are those which are actually used subsequently in instruction firing (figs. 35, 36, and 37.)

(5) *Instruction firing targets.*—(a) *Nonoverhead type target.*—The nonoverhead type target consists of eight silhouettes for each of which there are two scoring spaces; four silhouettes are used for pupils leading from left to right, and the remaining four silhouettes are used for pupils leading from right to left.

(b) *Overhead type target.*—The overhead type target consists of four silhouettes for each of which there is one scoring space.

(c) *Parachute type.*—The parachute type target consists of four silhouettes for each of which there is one scoring space.

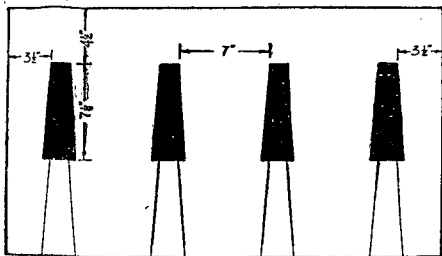

FIGURE 36.—Overhead instruction target.

(6) *Group firing targets* (fig. 38).—Group firing targets consist of two stakes suspended vertically from the moving cable on the horizontal nonoverhead target carrier. Four black silhouettes are mounted on each stake. The right stake is used for firing by pupils when tracking from left to

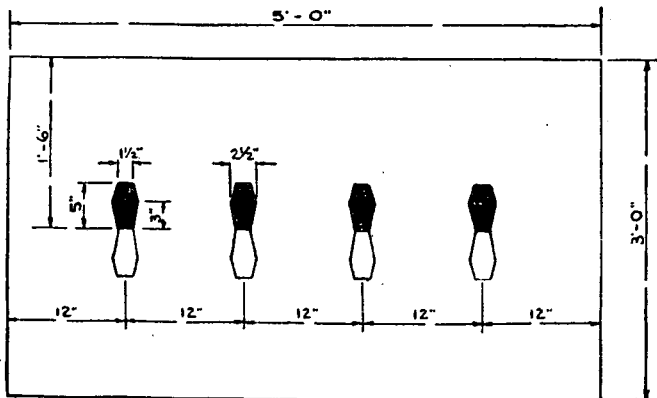

FIGURE 37.—Parachute instruction firing targets.

right; the left stake is used for firing by pupils when tracking from right to left.

■ 145. FIRST STEP: POSITION EXERCISES.—*a. General.*—The position used in antiaircraft firing should be one which can be assumed rapidly, afford the maximum flexibility to the body for manipulation of the automatic rifle, and one which

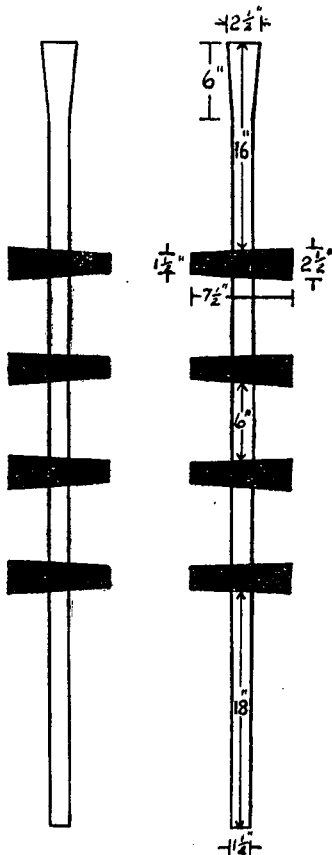

FIGURE 38.—Group firing target.

does not require undue exposure of the firer. This position will usually be kneeling, since it best meets the above requirements (par. 68 and fig. 25).

b. Field expedients.—Due to the inherent characteristics of the automatic rifle, the modified kneeling position is considered the usual position for firing at aerial targets. Under certain circumstances the automatic rifleman may be required to fire from the standing or reclining position and should receive some training in these positions (see FM 23-5).

c. Position training.—(1) All positions except the reclining position must be such that the automatic rifle, the body from the waist up, the arms, and the head move as one unit. When leading a target the rifle must be swung with a smooth, uniform motion. This is accomplished by pivoting the body at the waist; there should be no independent movement of the arms, shoulders, head, or the automatic rifle.

(2) The instructor explains and demonstrates the positions, and he explains that if the rifle is pulled or pushed in the desired direction by means of the left hand and arm it will move with a jerky motion. This increases the possibility of jerking the trigger or of pulling or pushing the front sight out of alinement.

(3) The instructor then requires his group to practice taking each antiaircraft position correctly, using the coach and pupil method of instruction. Through repetition and practice, each soldier is required to become proficient in assuming each position rapidly for firing at hostile aircraft moving in any direction.

■ 146. SECOND STEP: AIMING AND LEADING EXERCISE.—*a. Purpose.*—The purpose of the aiming and leading exercises is to teach the correct method of aiming and to develop skill in swinging the automatic rifle with a smooth, uniform motion so as to maintain the aim on aerial targets. Initially, students aim at a small black paster in order to practice taking an announced lead. Thus the instructor can vary the announced lead by having pupils aim at various pasters representing the announced lead.

b. Method.—(1) In the case of the nonoverhead targets (fig. 32), the pupils stand relaxed with their rifles pointing upward and in the general direction of the targets, elbows at

sides, and hands grasping the automatic rifle at the small of the stock and the forearm, ready to assume the designated position promptly. Pupils are placed in one line at intervals of about $1\frac{1}{2}$ yards, and 500 inches from and facing the assigned target (fig. 31①). The coaches take positions that enable them to observe their pupils. The commands for the exercise are: 1. AIMING AND LEADING EXERCISE, 2. ONE (TWO, THREE OR MORE) LEAD(S), 3. TARGETS. At the command TARGETS, the targets are operated at an approximate speed of 15 feet per second. The pupils assume the designated firing position rapidly, alining the sights on the silhouette or black paster representing the announced lead on the aiming and leading target. Then they swing their rifles with a smooth, uniform motion by pivoting their bodies at the waist, maintaining the aim on the announced lead during the travel of the target. The operation is continued until the target has been moved five times in each direction. The coaches and pupils then change places and the exercise is continued until all men have acquired skill in aiming and leading with various leads, both from right to left and from left to right, on the horizontal and the climbing and diving target (fig. 33).

(2) The group assigned to the two overhead aiming and leading targets is divided into four parallel lines facing the targets and perpendicular to the line of travel (fig. 31②). Pupils are arranged in the first and third lines; coaches, close behind their pupils, are placed in the second and fourth lines. Half of the pupils in each line aim and lead on the target as it approaches, while remaining pupils are aiming and leading on the other target as it recedes. All pupils continue to aim and lead their silhouettes as they change direction until each target has made five complete approaching and returning trips. Then pupils and coaches change places and repeat this procedure until all men have acquired skill in aiming and leading on the overhead target. Either one or no lead is used.

(3) The group assigned to practice on the parachute aiming and leading targets (fig. 34) is divided equally as coaches and pupils (fig. 31①). All pupils aim and lead on the descending target, tracking until the target reaches its lowest

point. All pupils continue to aim and lead their silhouettes until each target has made one or more descending trips. Either one or no lead is used. Coaches and pupils change places and the exercise is repeated.

c. Duties of coach.—In the aiming and leading exercise, the coach insures that the—

- (1) Proper position is taken.
- (2) Rifle is swung with a smooth motion.
- (3) Rifle is swung by pivoting the body at the waist.
- (4) Arms, shoulders, automatic rifle, and head move as a unit.

■ 147. THIRD STEP: TRIGGER-PRESS EXERCISES.—*a. Importance.*—(1) Correct trigger press is the most important operation to be performed in firing the automatic rifle. The automatic rifleman should be trained to press the trigger exactly as when firing rapid single shots at stationary ground targets, except that *the automatic rifle is kept in motion during the trigger press, during the firing of the burst, and after the firing of the burst (follow-through).*

(2) In firing at a rapidly moving target, the untrained automatic rifleman has a tendency to permit the automatic rifle to come to rest momentarily while applying the final pressure. This results in the shot passing behind the target. Another fault of the untrained man is that of pulling the trigger quickly the instant the aim is on the required lead. This causes the alinement of the sight to become disarranged.

(3) Because of the short period of time during which the usual aerial target will be within effective range, fire should be opened as soon as possible and delivered as rapidly as possible consistent with accuracy. The trigger should therefore be pressed promptly and decisively. Once started, the press should be continued until the slide is released.

(4) Skill in pressing the trigger properly when firing at rapidly moving targets is difficult to acquire. Although automatic riflemen will have had training in trigger pressing during their course in stationary ground target marksmanship, firing at rapidly moving targets introduces certain additional elements which must be overcome before skill is acquired. Since practice in taking correct positions rapidly, aiming, and leading are included in trigger-press exercises,

the greater part of the time allotted to preparatory exercises should be devoted to trigger press.

b. Object.—The primary object of the trigger-press exercises is to train the automatic rifleman to apply pressure on the trigger while keeping the automatic rifle in motion, to develop a decisive trigger press so that fire can be opened in a minimum of time without loss of accuracy, and to train him to follow through with the shot. In this training, the necessity of a smooth swing and follow-through, at the time the bolt strikes home, is second in importance only to the trigger press itself.

c. Method.—(1) Trigger-press exercises on nonoverhead targets are conducted in a manner similar to that used in conducting the aiming and leading exercises except as noted below.

(2) The commands for the exercise are: 1. TRIGGER-PRESS EXERCISE, 2. SIMULATE LOAD, 3. SQUADS ONE AND THREE FROM RIGHT TO LEFT (OR LEFT TO RIGHT), 4. SQUADS TWO AND FOUR FROM LEFT TO RIGHT (OR RIGHT TO LEFT), 5. ONE (TWO, OR MORE) LEAD(S), 6. TARGETS.

NOTE.—Squads one, two, three, and four refer only to the organization for training, shown in figure 31.

At the command TARGETS, the targets are operated at the prescribed speed; the pupils rapidly assume the designated firing position; mentally apply the target length as a unit of measure in measuring the lead announced in the order; direct the aim on that point; and, by swinging the rifle in the manner taught and practiced in the aiming and leading exercise, maintain the aim at the announced lead. At the same time they apply a constantly increasing pressure on the trigger until the slide (hammer) is released. *The aim is maintained during the entire length of travel of the target regardless of the time of release of the slide.* The importance of following through with the shot cannot be too strongly emphasized. It is only by this means that men will develop the habit of keeping their rifle in motion during the entire process of firing. All of these steps are performed as one continuous operation. The exercise consists of pressing the trigger each time the target moves across the front. The target having reached the end of its movement across the

firer's front, the automatic rifleman *quickly* swings his rifle back to the beginning of the target run, cocks the piece, and anticipates the return of the target to that end of the run. The exercise consists of five passages of the target in each direction. The coach and pupil then change places, and work is continued until all men have become proficient in pressing the trigger correctly, using various leads. It is essential that training be provided for targets moving in both directions. Experience has shown that leading from left to right is more difficult than leading from right to left.

NOTE.—All preparatory exercises of the automatic rifle in anti-aircraft marksmanship training should be carried on with the Browning automatic rifle M1918A2, in order to acquaint the firer with the proper trigger press, weight of rifle, and movement of the rifle when the slide moves forward.

(3) The group receiving instruction in trigger-press exercises on overhead targets is arranged as for aiming and leading exercises (fig. 31②). The instruction is conducted in a similar manner, except that when the target reaches the end of its run the firer does not track the movement in the opposite direction. He swings his point of aim quickly back to the starting point and continues the trigger-press exercise as described above for nonoverhead targets. The commands for this exercise are: 1. TRIGGER-PRESS EXERCISE, 2. SIMULATE LOAD, 3. SQUADS ONE AND THREE, APPROACHING TARGETS, 4. SQUADS TWO AND FOUR, RECEDING TARGETS, 5. ZERO (ONE) LEAD, 6. TARGETS.

(4) The group receiving instruction in trigger-press exercises on the parachute targets is arranged as for aiming and leading exercises (fig. 31①). The commands for the exercise are: 1. TRIGGER-PRESS EXERCISE, 2. SIMULATE LOAD, 3. ZERO (ONE) LEAD, 4. TARGETS. At the command TARGETS, the targets are operated at the prescribed speed; squads one and two simulate fire at the descending right targets. When the left targets reach the top of the carrier and start down, squads three and four simulate fire thereon.

d. Duties of coach.—In trigger-press exercises the coach sees that the—

- (1) Proper position is taken.
- (2) Rifle is swung with a smooth, uniform motion.
- (3) Rifle is swung by pivoting the body at the waist.

(4) Arms, shoulders, and head move as a unit as the rifle is moved.

(5) Pressure on the trigger is applied promptly, decisively, and continuously.

(6) Eye is kept open and does not blink at the instant the slide is released, if using the automatic rifle.

(7) Muzzle does not jerk coincident with the release of the hammer if using the caliber .22 rifle.

(8) Pupil continues the aim during the entire length of travel of the target.

(9) Rifle butt is kept on the shoulder while reloading the caliber .22 rifle.

SECTION IV

MINIATURE RANGE PRACTICE

■ 148. GENERAL.—*a.* Miniature range practice is divided into two parts, instruction firing and group firing. There is no record firing.

b. All firing is on moving targets on the 500-inch range. A suggested arrangement of the range is given in paragraph 158. Provision is made for simultaneous firing by separate groups on the horizontal, the climbing and diving, the overhead, and the parachute targets.

c. The course should first be fired with the caliber .22 rifle, after which, if the supply of ammunition and the danger area permit, the Browning automatic rifle, caliber .30, M1918A2 should be used. Single shots or short bursts of two or three rounds will be fired.

■ 149. SAFETY PRECAUTIONS.—The applicable safety precautions given in paragraph 241 will be observed.

■ 150. INSTRUCTION FIRING.—*a. General.*—(1) The purpose of instruction firing is to provide a means of applying the principles taught in the preparatory exercises.

(2) During instruction firing, the soldier works under the supervision of a coach.

(3) As a group completes the preparatory training on a target, instruction firing should be taken up on that target and completed before the group moves to another target.

(4) Instruction firing consists of the exercises indicated in table I, below.

b. Procedure.—(1) As the instruction firing on each type of target follows immediately after the preparatory exercises on that target, the organization of the training unit for firing should be the same as that given in paragraph 144b.

(2) The front rank of each group is formed on the firing line in the designated firing position. The men in the rear rank act as coaches.

(3) One-half of the front rank pupils of the group fires while the remaining front rank men simulate firing (fig. 31①). In this way, men are kept busy and receive additional preparatory instruction while waiting their turn to fire. This organization is, in effect, a "double" coaching system for squads (fig. 31).

(4) Silhouettes are assigned to each individual firer. For example, the four silhouettes on the right of the targets are assigned the first four men on the right of the line; the four silhouettes on the left of the targets are assigned the next four men. Silhouettes for the men simulating firing are assigned in the same manner; for example, the right four are assigned silhouettes on the right of the target and the left four are assigned silhouettes on the left of the target (par. 144c).

(5) When the men are in the desired firing position, the officer in charge of the firing commands: 1. SQUADS ONE AND TWO, LOAD, 2. SQUADS THREE AND FOUR, SIMULATE LOAD, 3. SQUADS ONE AND THREE, FROM RIGHT TO LEFT, 4. SQUADS TWO AND FOUR, FROM LEFT TO RIGHT, 5. ONE (TWO OR MORE) LEADS, 6. TARGETS. At the command TARGETS, the targets are operated at the prescribed speed. Pupils on the right half of the nonoverhead targets mentally apply the length in measuring the announced lead. They direct their aim on that point, and, while maintaining the aim, press the trigger until the shot is fired. *They continue to aim during the entire length of travel of the target, regardless of the time at which the shot was fired.* When the target reaches the end of its run, firers quickly swing their point of aim back to the starting point and promptly begin to aim when the target begins its next trip. They fire one shot each time the target crosses

from their left to right. Pupils on the left half of the same targets aim and fire one shot in the same manner as explained above each time the target crosses from their right to left.

(6) Pupils on the overhead target fire one round each time the target is operated; those assigned to the approaching target fire only as the target approaches; similarly, those assigned to the receding target fire only as the target recedes from the firing point. All pupils apply the announced target length lead, aim, press the trigger, follow through, and then swing back to the starting point as described above for the pupils firing on the nonoverhead targets. The commands given in (5) above are made applicable to overhead target firing by substituting the words "approaching targets," and "receding targets" for "right to left" and "left to right," respectively.

(7) When firing on parachute targets, the men on the right (left) being in the designated firing position, the officer in charge of firing commands: 1. SQUADS ONE (TWO) AND THREE (FOUR) LOAD, 2. SQUADS TWO (ONE) AND FOUR (THREE) SIMULATE LOAD, 3. ZERO (ONE) LEAD, 4. TARGETS. At the command TARGETS, squad one fires while squad two simulates fire at the right descending target. When the left target reaches the top of the carrier and starts down, squad three fires on that target during its descent while squad four simulates fire thereon. After all pupils have fired, coaches and pupils change places, and the exercises are repeated in a similar manner until all men have fired.

(8) Four rounds constitute a score. However, nonoverhead and overhead targets are usually operated for five complete round trips. Thus men whose rifles have malfunctioned (jammed) are allowed an opportunity to fire any remaining shots. After each string of four rounds has been fired, targets are scored and the shot holes are marked. One method for such marking is to place a piece of white chalk on the shot hole and give the chalk a quick twist.

(9) One point is awarded for each hit in the silhouette when using one lead or in the proper scoring space when using more than one lead.

(10) Half groups alternate firing and simulating firing.

(11) When front rank men have fired two scores, one as the target moved in each direction, they change places with the men in the rear rank. They then coach the rear rank men.

(12) This procedure is followed until all men of the group have performed the required firing at that target.

(13) Upon completion of the firing prescribed in table I for any one type of target, the group moves to another type target and continues until all have completed the preparatory training and instruction firing.

TABLE I.—INSTRUCTION FIRING (RANGE 500 INCHES)

Target	Sitting	Kneeling	Standing	Total	Remarks
Horizontal	<i>1 lead</i> 4 rounds L to R 4 rounds R to L	<i>2 leads</i> 4 rounds L to R 4 rounds R to L	<i>3 leads</i> 4 rounds L to R 4 rounds R to L	24	Fig. 42⊙.
Climbing or diving.	4 rounds L to R 4 rounds R to L	4 rounds L to R 4 rounds R to L	4 rounds L to R 4 rounds R to L	24	Fig. 42⊙.
Overhead	<i>0 lead</i> 4 rounds approaching. 4 rounds receding.	<i>0 lead</i> 4 rounds approaching. 4 rounds receding.	<i>1 lead</i> 4 rounds approaching. 4 rounds receding.	24	Fig. 42⊙.
Parachute	<i>0 leads</i> 4 rounds	<i>0 leads</i> 4 rounds	<i>1 lead</i> 4 rounds	12	Fig. 46.

Speed of all targets except the parachute target, 15 feet per second.

Speed of the parachute target, 1 foot per second.

(14) Modifications of the above method of firing to meet local conditions are authorized.

■ 151. GROUP FIRING.—*a. General.*—(1) Group firing is the final phase of antiaircraft marksmanship training on the miniature range.

(2) It provides for competition and illustrates the effectiveness of the combined fire of a number of riflemen.

(3) Group firing should not be undertaken until the pre-

paratory training and instruction firing have been completed.

b. Procedure.—(1) Two group firing targets (fig. 38), one to be fired upon as the target moves from left to right and one to be fired upon as the target moves in the opposite direction, are assigned to each squad or similar group.

(2) All men are arranged as shown in figure 31①. All pupils fire four rounds on assigned silhouettes as the target moves from right to left and then from left to right. Coaches and pupils change places and the exercise is repeated for rear rank men, now in position as pupils.

(3) Targets are not scored until completion of the firing of the entire squad or group.

c. Scoring.—A value of *one* is given each hit on the silhouette.

SECTION V

TOWED TARGET AND RADIO-CONTROLLED PLANE TARGET FIRING

■ 152. GENERAL.—*a.* The following types of targets are used in towed target and radio-controlled plane target firing using ball, armor-piercing, tracer, or a combination of tracer and one of the other types of ammunition.

(1) *Towed sleeve targets.*—Fifteen feet long with a diameter of 3 feet.

(2) *Towed flag targets.*—Forty feet by nine feet, equipped with weights so that the width (9 feet) is displayed to the firer as width and height, respectively, when the target is moving directly toward (away from) the man, or across the front.

(3) *Radio-controlled plane targets.*—Approximately 10 feet long, 12-foot wing spread, and 2 feet high.

NOTE.—Prior to actual firing, practice in aiming and leading and trigger-press exercise may be conducted, using airplanes as targets.

b. Towed target or radio-controlled plane target firing will follow miniature range instruction firing. If, because of lack of facilities, a unit is unable to conduct miniature range firing, it may be permitted to conduct towed target or radio-

controlled plane target firing, provided antiaircraft marksmanship preparatory training has been completed.

c. A hit on the engine or radio of the radio-controlled plane target will cause the parachute to open. The command to cease firing will be given as soon as the parachute is released.

■ 153. COURSES TO BE FIRED.—Units authorized to fire will fire one or more of the courses enumerated in table II or table III.

■ 154. SAFETY PRECAUTIONS.—See applicable safety precautions in paragraph 241.

■ 155. PROCEDURE OF FIRING.—*a.* The men to fire take their places on the firing line with at least 1½ yards interval between men. They then assume the antiaircraft firing position designated by the officer in charge of firing.

b. The officer in charge of firing takes position in rear of the center of the firing line.

c. Safety officers take position at either flank of the firing line.

d. As the target approaches the left (right) side of the danger area, the officer in charge of firing gives the command: 1. (SO MANY) ROUNDS, LOAD, 2. TARGET FROM THE LEFT (RIGHT). Each automatic rifleman cocks his piece, inserts a magazine, and turns the change lever to safe.

e. As the target approaches the danger area, the officer in charge of firing commands: 3. SIX LEADS (par. 141c). At this preparatory command, each automatic rifleman turns the change lever to the slow cyclic rate, aims by swinging to the announced lead, pivoting at the waist, and maintains the estimated lead.

f. For exercises in firing at crossing targets, the safety officer stationed at the end of the firing line, opposite to the target's approach, signals or commands COMMENCE FIRING when the target has completely crossed the line marking the firing area. The officer in charge of firing and such assistants as he desires repeat the command or signal to insure that all firers hear it. Each automatic rifleman presses the trigger until the slide is released. He continues to aim and fire rapidly until the command or signal CEASE FIRING is given.

TABLE II.—TOWED TARGET COURSES TO BE FIRED

Course No.	Type of flight	Altitude of target	Horizontal range (yards) ¹	Speed	Remarks
1	Nonoverhead horizontal (parallel to firing line from L to R).	Minimum consistent with safety.	Minimum, 100; maximum depends on width of danger area of range.	15 foot sleeve, 140 mph 40 foot flag, 165 mph.	None.
2	Nonoverhead horizontal (parallel to firing line from R to L).	do.	do.	do.	None.
3	Overhead (perpendicular to firing line).	do.	{ Minimum } { Maximum } In accordance with safety precautions.	do.	Fig. 39.
4	Combined courses 1, 2, and 3.	do.	Same as for courses 1, 2, and 3.	do.	Fig. 40.

¹ The horizontal distance from the firing point to a point directly under the target.

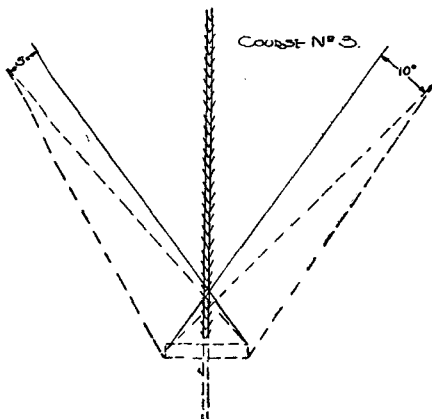

FIGURE 39.—Course No. 3. (Firing takes place when target is on shaded portion of course. Fire is opened when towing airplane is 50 yards or less from firing point.)

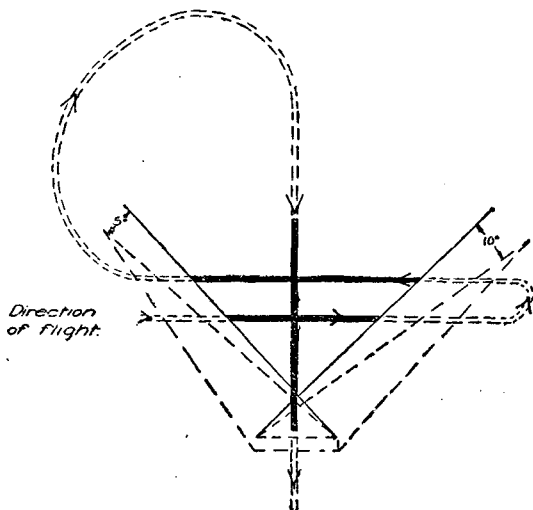

FIGURE 40.—Course No. 4. (Heavy lines indicate when towed target is fired upon.)

TABLE III.—RADIO-CONTROLLED PLANE TARGET COURSES TO BE FIRED

Course	Type of flight	Ground range to nearest 25 yards	Altitude to nearest 25 feet	Slant range in yards (approximate)	Speed	Number of runs	Remarks
1	Nonoverhead.....	300	200	300	95	1 L to R..... 1 R to L.....	None.
2	Nonoverhead.....	300	800	400	95	1 L to R..... 1 R to L.....	None.
3	Nonoverhead.....	300	1, 200	500	95	1 L to R..... 1 R to L.....	None.
4	Overhead.....	550-150	750	600-300	95	1 approaching.....	None.
5	Overhead.....	150-550	750	300-600	95	1 Receding.....	None.
6	Overhead diving.....	550-150	750-250	600-175	Max.	1 approaching.....	Fig. 41.
7	Overhead climbing.....	150-550	250-500	175-600	Max.	1 receding.....	Fig. 41.
8	Oblique diving.....	500-225	1, 000-600	600-300	Max.	1 incoming.....	Fig. 41.
9	Oblique climbing.....	225-500	600-750	300-600	Max.	1 outgoing.....	Fig. 41.

NOTE.—Courses 1, 2, and 3 will be flown on an arc of constant range, elevation, and speed. The maximum slant range for all courses should not exceed 600 yards.

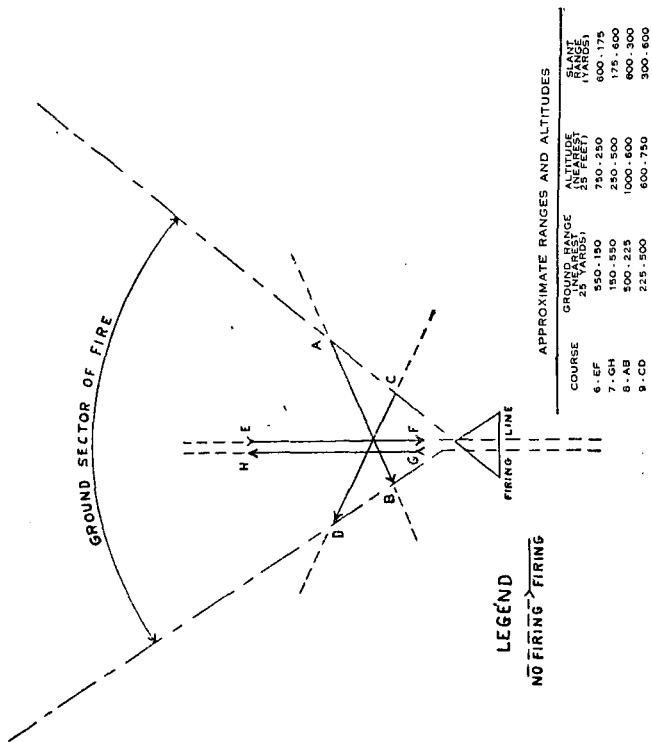

Figure 41.—Radio-controlled plane target course.

The safety officer at the end of the firing point opposite to the target's departure observes the flight of the target during the firing. When he observes that the target is about to leave the firing area, he signals or commands **CEASE FIRING**. The officer in charge of firing and his assistants repeat the command or signal to insure that all firers hear it.

g. In firing at overhead targets, the same procedure is followed except that the officer in charge of firing (from his position behind the center of the firing line) determines when firing commences and ceases; in towed target firing, he gives the command or signal to **COMMENCE FIRING** when the towing plane is 50 yards or less in front of the firing line and gives **CEASE FIRING** before the sleeve is 100 yards in front of the firing line (par. 241).

■ 156. **SCORING.**—*a.* The number of hits is found by dividing the number of holes in the target by 2. An odd hole is counted as a hit.

b. The hit percentage is obtained by dividing the number of hits as obtained in *a* above by the total number of rounds fired at the target.

SECTION VI

RANGES, TARGETS, AND EQUIPMENT

■ 157. **RANGE OFFICER.**—A range officer is appointed well in advance of range practice. His chief duties are—

a. To make timely estimates for material and labor to place the range in proper condition for firing.

b. To supervise and direct the repairs and alterations to installations.

c. Where safety demands, to instruct and supervise range guards.

■ 158. **MINIATURE RANGE.**—*a.* The miniature range consists of—

- (1) One horizontal target (fig. 42①).
- (2) One double climbing and diving target (fig. 42②).
- (3) One overhead target (fig. 42③).
- (4) One parachute target (fig. 46).

b. A suggested arrangement of the targets is shown in figure 48.

c. For details of targets, see figures 32 to 38, inclusive.

d. For details of range apparatus, see figures 42 to 48, inclusive, and TM 9-855.

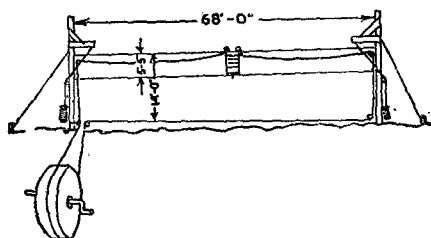

① Horizontal.

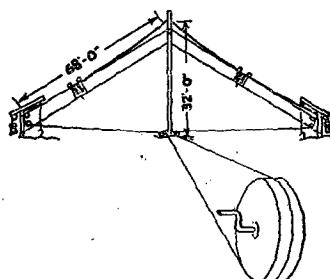

② Climbing and diving.

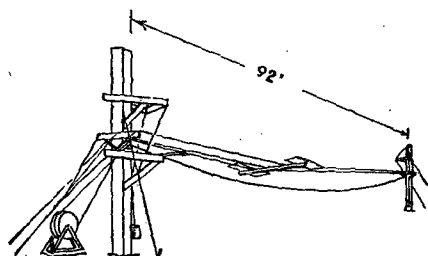

③ Overhead.

FIGURE 42.—Diagrams showing types of miniature range targets

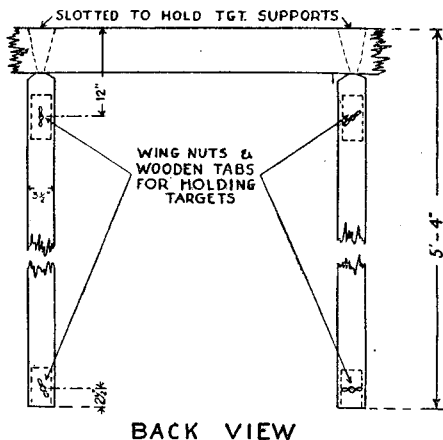
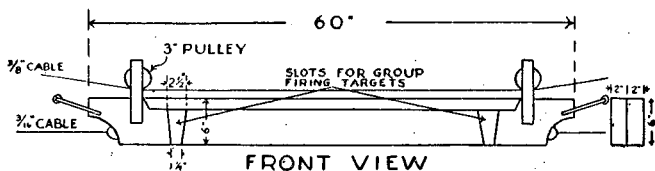

SUPPORTS FOR INDIVIDUAL FIRING TARGETS

FIGURE 43.—Target carrier used on horizontal and on climbing and diving miniature range targets. (See fig. 42① and ②).

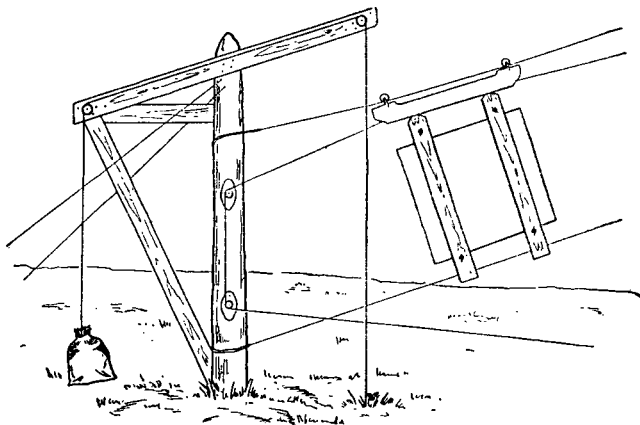

FIGURE 44.—Details of climbing and diving target (rear view).

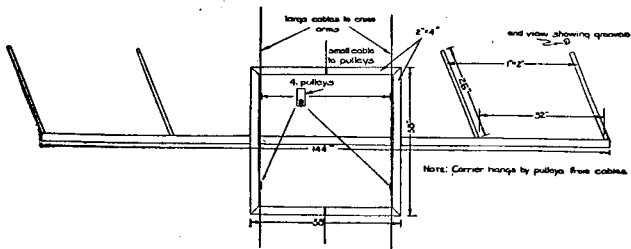

FIGURE 45.—Overhead target carrier.

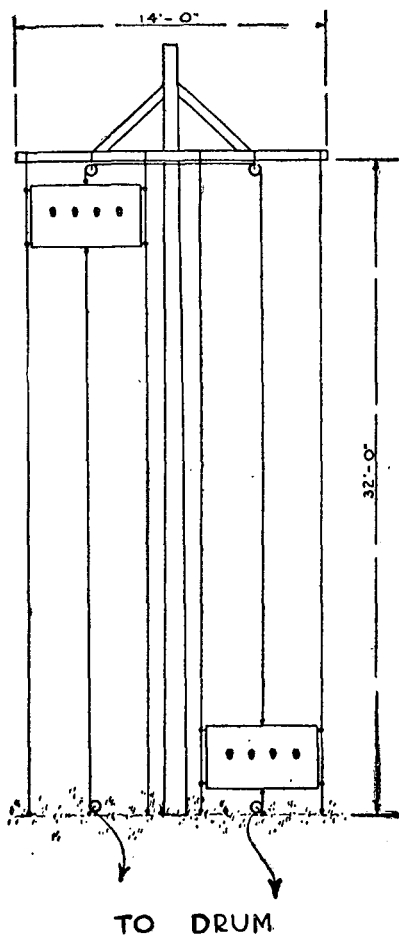

FIGURE 46.—Miniature parachute target course and target carrier.

e. (1) The danger area required is dependent upon the type of ammunition. (For information on sizes and shapes of danger areas, see AR 750-10.)

(2) The miniature range may be laid out in the manner shown in figure 48. Care must be taken to insure that the firing line and targets are placed so that no fire will fall outside of the firing area.

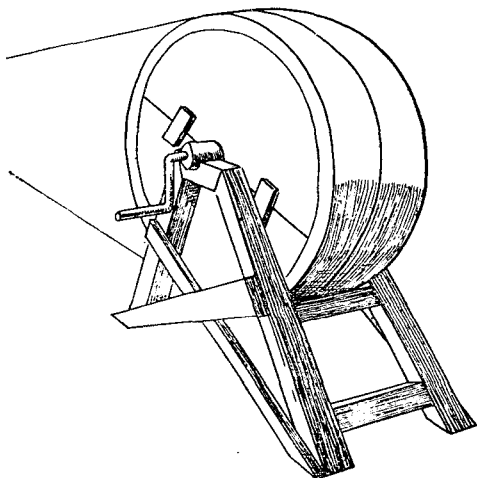

FIGURE 47.—Cable drum.

f. If the organization for training is as suggested in paragraph 144b, the following equipment is necessary:

(1) Eighty caliber .22 rifles. (If not available, the organization for training should be altered accordingly.)

(2) Seven aiming and leading targets (figs. 32, 33, and 34). (Each of these targets consists of a piece of beaverboard on which the silhouettes are pasted or stenciled.)

(3) Six instruction firing targets per range (figs. 35, 36, and 37). (The overhead and parachute targets are the same as the aiming and leading overhead and parachute targets except that the pasters are eliminated.)

(4) One score card per man.

Figures shown below each firing point indicate the number of men who can be satisfactorily trained on such a range. If an increased capacity is desired, appropriate increases in available facilities should be made.

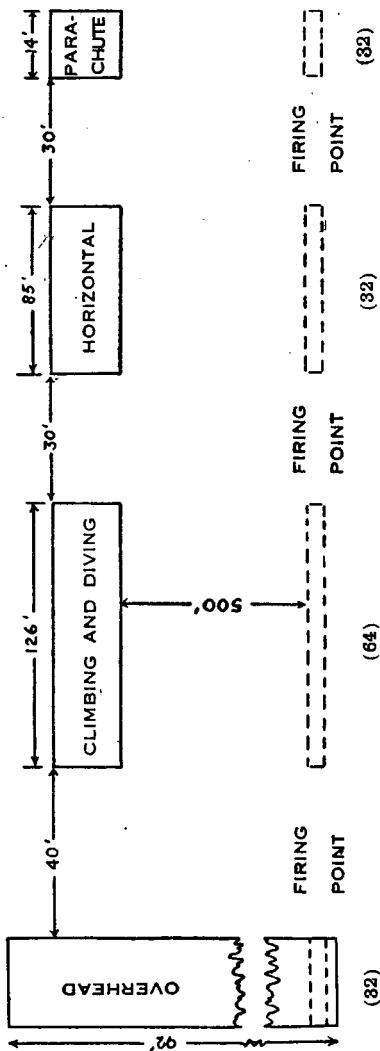

FIGURE 48.—Arrangement of targets.

INDIVIDUAL SCORE CARD
ANTI-AIRCRAFT RIFLE MARKSMANSHIP

Name _____ Date _____, 19...

Target	0 leads			1 lead			2 leads			3 leads		
	Rounds fired	Hits	Percent	Rounds fired	Hits	Percent	Rounds fired	Hits	Percent	Rounds fired	Hits	Percent
Horizontal	X											
Climbing												
Diving												
Overhead							X					
Parachute												
Total												

■ 159. FIELD FIRING.—*a.* In selecting the location of a range for field firing at aerial targets, the danger area is the chief consideration (AR 750-10).

b. The firing point should accommodate at least 50 men in line with a 1½-yard interval between men. A level strip of ground, preferably on a hill, 75 yards long and 2 yards wide, is suitable. A firing point similar to the firing point of a class A rifle range may be built.

c. (1) After the range has been selected, the firing point, limits of fire, and danger area should be plotted on a map or sketch of the area.

(2) From this map or sketch, the range is then laid out on the ground. First, each end of the firing point is marked by a large stake. The right and left limits of fire are then each marked by a post. The posts are located in azimuth

by the following method: To locate the post marking the left limit of fire, an aiming circle or other angle measuring instrument is set up at the right end stake of the firing point. It is then oriented and laid on an azimuth which, by reference to the map or sketch, is known to be the farthest to the left that the rifle can safely be fired from its position at the right end of the firing point. The post marking the right limit of fire is similarly located with the instrument set up at the left end stake of the firing point. Each post is placed at the maximum distance at which it will be plainly visible from the firing point (fig. 49).

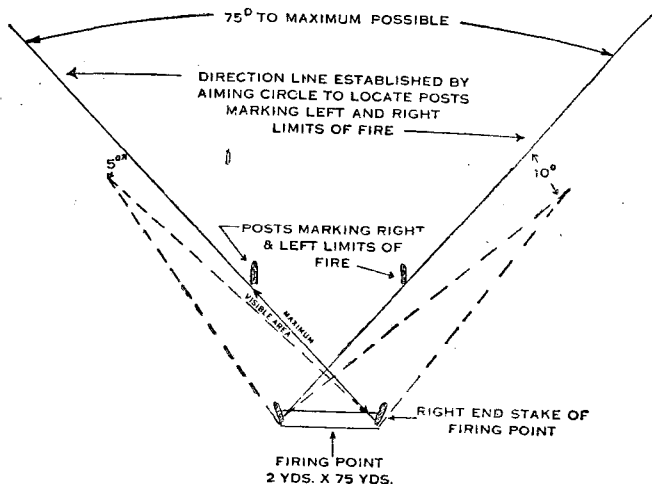

FIGURE 49.—Towed target range showing firing point and limits of fire; dotted lines show danger area.

(3) Direction guides for the towing airplane to follow should, within the limits of fire, be distinctly marked on the ground for each course. White targets or strips of cloth, placed flat on the ground about 30 feet apart, are suitable.

■ 160. TARGETS.—*a. Type and source.*—The targets used in towed target firing are sleeve or flag targets furnished by the air force unit assigned the towing mission (par. 152). They are returned to the air force unit after they have been scored.

Radio-controlled plane targets will be obtained through the division commander.

b. Towline.—The towing line for the towed target will be not less than 600 yards long.

■ 161. INSTRUCTIONS TO PILOTS FOR TOWING MISSIONS.—*a.* Towed target firing requires the closest cooperation between the pilot of the towing plane and the officer in charge of firing. Decisions affecting the safety of the plane rest with air force personnel.

b. The air mission for towed target firing should be specifically stated. The commanding officer requesting airplanes for towed target firing should furnish in writing to the air force unit commander concerned, the following information:

(1) Place of firing.

(2) Date and hour of firing.

(3) Number of missions to be flown; altitude, course, speed, and number of runs for each.

(4) Ground signals to be used.

(5) Map of the area with the firing line, angle of fire, danger area, course of each mission, and location of the grounds for dropping targets and messages plotted thereon. An alternate dropping ground should be designated when practicable with either or both dropping grounds subject to approval by the pilot.

(6) Length of the towline, within limits established by the air force and subject to approval of the pilot.

(7) Number of targets required.

c. Whenever practicable, the officer in charge of the firing will discuss with the pilot the detailed arrangements mentioned in *b* above. This discussion should take place where the various range features can be pointed out to the pilot. The courses over which the airplane is to be flown should be distinguished on the ground (within the angle of fire). Machine-gun targets placed flat on the ground about 30 feet apart or strips of target cloth are practicable for this purpose on some courses. On others a terrain feature such as a beach line may be used.

■ 162. SIGNALS.—*a.* Direct radio communication is the most effective means by which the officer in charge of firing and

the pilot of the towing plane maintain contact with each other. Even though radio is being used, panels should be available in case radio communication fails.

b. For signaling from the ground to the pilot, any method agreed upon by the officer in charge of firing and the pilot of the towing airplane may be used. The panel signals generally used are as follows:

Stand by -----	0	0	2.
Ready to fire-----	0	0	0.
Repeat run No. 1-----	0	9	1.
Repeat run No. 2-----	0	9	2.
Repeat run No. 3-----	0	9	3.
Repeat course-----	0	9	4.
Mission complete-----			Pick up panels.

c. The pilot may also communicate with the officer in charge of firing by dropped messages or by rocking his wings.

d. When the radio-controlled plane target is used, it is essential that the radio control operator be able to cause the firing to cease immediately. This can best be accomplished by the use of a klaxon or siren. Some system of prearranged signals must exist between the radio control operator and the officer in charge of firing.

CHAPTER 5

TECHNIQUE OF FIRE

	Paragraphs
SECTION I. General.....	163-165
II. Range estimation.....	166-170
III. Target designation.....	171-174
IV. Automatic rifle fire and its effect.....	175-181
V. Application of fire.....	182-189
VI. Landscape target firing.....	190-197
VII. Field target firing.....	198-201
VIII. Destruction of ordnance matériel.....	202

SECTION I

GENERAL

■ 163. DEFINITIONS.—*a.* The training of riflemen and automatic riflemen for combat is progressive in nature and includes three phases. The *first phase* is individual training and comprises such allied subjects as marksmanship, extended order, drill and combat signals, and certain elements of scouting and patrolling. The *second phase* is called "technique of fire" and is team training consisting of instruction in the application and control of the collective fire of rifle fire units. In the *third phase*, the individual and team training learned in the first and second phases are combined with tactical training. This chapter deals with the second phase of training.

b. Collective fire is the combined fire of a group of individuals.

c. A fire unit is one whose fire in battle is under the immediate and effective control of its leader. The usual rifle fire unit is the squad.

■ 164. IMPORTANCE OF AUTOMATIC RIFLE FIRE.—Effective automatic rifle and rifle fire is an element which may determine the issue of battle. Collective fire is most effective when it is the product of teamwork. Training in the technique of fire, as set forth in this chapter, is designed to train rifle squads to act as efficient and dependable teams in the application and control of collective fire.

■ 165. SCOPE.—*a.* Training in the technique of fire does not involve the solution of tactical situations. However, a tactical situation is presented in each exercise to form the basis for instruction in the principles of technique of fire; and such subjects as the use of cover and concealment in the selection and occupation of positions, the selection and engagement of targets, and others used in the application of fire, should be included in the training in technique of fire. Instruction is progressive and is divided into six consecutive steps. Each step includes some or all of the technique learned in previous steps. The steps are as follows:

- (1) Range estimation.
- (2) Target designation.
- (3) Rifle and automatic rifle fire and its effect.
- (4) Application of fire.
- (5) Landscape target firing.
- (6) Field target firing.

b. It is not essential that perfection be reached in each step before proceeding to the next step; it is better that such a standard be attained by repetition, applying in the steps that follow everything that has been learned. However, each step should be understood before proceeding to the next. The instructor explains each step in detail. He then makes plain its relation to the subject as a whole. This is followed by a demonstration, which in turn is explained by the instructor. The troops then practice the principles and methods previously explained and demonstrated. Exercises pertaining to each step are hereinafter described in detail. They can be used for demonstrations and instructional practice. Some of them can be used to test fire units, thus introducing the desirable element of competition. These exercises may be changed to conform to local conditions.

SECTION II

RANGE ESTIMATION

■ 166. IMPORTANCE.—In battle, ranges are seldom known in advance, so that the effectiveness of fire depends in large measure upon the accuracy of range estimation.

■ 167. METHODS.—Of the various methods of estimating ranges, only the following are considered in instruction in the technique of fire:

- a. Use of tracer bullets.
- b. Observation of fire.
- c. Estimation by eye.

■ 168. USE OF TRACER BULLETS.—When the range to a target is being estimated by the use of tracer bullets, one of the scouts or the leader estimates the range by eye, sets his sight for that range, and fires a tracer bullet the path and strike of which are observed by the second scout or a designated observer. The firer corrects the sight setting according to the strike of the bullet and continues to fire and correct the sight setting until a tracer appears to strike the target. The firer then announces by voice or signal the required range setting to hit the target, taking into consideration the zero of his rifle.

■ 169. OBSERVATION OF FIRE.—This method can be used when the ground is dry and the strike of the bullets can be observed. The procedure is the same as that used in determining the range by tracer bullets. The following points must be taken into consideration:

- a. Dust will appear slightly above the striking point of the bullet.
- b. If observing from the firing point, dust will appear on the side toward which the wind is blowing.
- c. If observing from a point on the flank, shots which pass over the objective will appear to strike on the side toward which the observer is posted; those which fall short, toward the opposite side.

■ 170. ESTIMATION BY EYE.—a. *Necessity for training.*—The usual method of estimating ranges in combat is estimation by eye. Untrained men make an average error of 15 percent of the range when estimating by eye. Hence a definite system of range estimation, coupled with frequent practice on varied terrain, is essential to success with this method.

b. *Unit of measure method.*—(1) Ranges less than 500 yards are measured by applying a mental unit of measure 100 yards

long. Thorough familiarity with the 100-yard unit and with its appearance on varied terrain and at different distances is necessary, if the soldier is to apply it accurately.

(2) Ranges greater than 500 yards are estimated by selecting a point halfway to the target, applying the unit of measure to this halfway point, and then doubling the result.

(3) The average of a number of estimates by different men will generally be more accurate than a single estimate. This variation of the suggested method is used when time permits by taking the average of the estimates of members of the squad or specially qualified men.

c. Appearance of objects.—In some cases, much of the ground between the observer and the target will be hidden from view, and the application of the unit of measure will be impossible. In such cases, the range is estimated by the appearance of objects. Whenever the appearance of objects is used as a basis for range estimation, the observer must make allowance for the following effects:

(1) Objects seem nearer—

(a) When the object is in a bright light.

(b) When the color of the object contrasts sharply with the color of the background.

(c) When looking over water, snow, a wheatfield or any uniform surface.

(d) When looking downward from a height.

(e) In the clear atmosphere of high altitudes.

(f) When looking over a depression most of which is hidden.

(2) Objects seem more distant—

(a) When looking over a depression most of which is visible.

(b) When there is a poor light, or fog.

(c) When only a small part of the object can be seen.

(d) When looking from low ground upward toward higher ground.

d. Exercises.—(1) *No. 1.*—(a) *Purpose.*—To familiarize the soldier with the unit of measure—100 yards.

(b) *Method.*—The unit of measure (100 yards) is previously staked out on one or more courses over varied ground (fig. 50), using markers that will be visible up to 500 yards.

In order to familiarize the men with the appearance of the unit of measure, they are conducted to a starting point which should be centrally located if more than one course is to be practiced. They are then moved to a point that is 100 yards (400-yard marker) from the selected 500-yard marker and are formed approximately on line facing that marker. Then they are required to move back toward the starting point until all are on line with the 300-yard marker, actually thus being 200 yards from the 500-yard marker. Successively they are moved to a point on line with the 200- and 100-yard

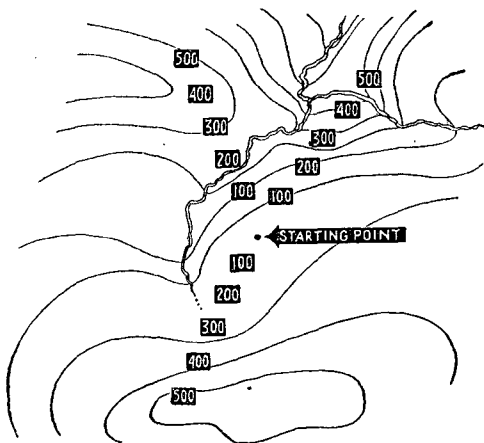

FIGURE 50.—Schematic lay-out illustrating an area used for teaching the 100-yard unit of measure.

markers, thence to the starting point. At each of the stopping points, men are required to study the appearance of the unit of measure and to apply it successively up to 500 yards. This exercise should be practiced at each of the several ranges in the prone, sitting, squatting, kneeling, and standing positions. The unit receiving instruction may be divided into two or more smaller groups, each practicing successively on the several courses. The exercise is repeated until the desired proficiency is attained.

(2) *No. 2.—(a) Purpose.*—To illustrate the application of the unit of measure.

(b) *Method.*

1. Ranges up to 900 yards are measured accurately and marked at every 100 yards by large markers or target frames, each bearing a number to indicate its range. Men undergoing instruction are then placed about 25 yards to one side of the prolonged line of markers and directed to place a hat or other object before their eyes so as to exclude from view all of the markers. They are then directed to apply the unit of measure five times along a straight line parallel to the line of markers. When they have selected the final point, the eye cover is removed and the estimations of the successive 100-yard points and the final point are checked against the markers. Accuracy is gained by repeating the exercise.

2. Ranges greater than 500 yards are then considered. With the markers concealed from view, men estimate the ranges to points which are obviously over 500 yards distant and a little to one side of the line of markers. As soon as they have announced each range, they remove their eye covers and check the range to the target and to the halfway point by means of the markers. Prone, sitting, squatting, kneeling, and standing positions are used during this exercise.

(3) *No. 3.—(a) Purpose.*—To give practice in range estimation.

(b) *Method.*—From a suitable point, ranges are previously measured to objects within 1,000 yards. The men are required to estimate the ranges to the various objects as they are pointed out by the instructor, writing their estimates upon paper or cards previously issued (par. 232). At least one-half of the estimates are made from the prone or sitting (squatting) positions. Thirty seconds are allowed for each estimate. When all ranges have been estimated, the papers are collected and the true ranges announced to the class.

To create interest, individual estimates and squad averages may be posted on bulletin boards.

(4) *No. 4.—(a) Purpose.*—To demonstrate a soldier's appearance at various ranges.

(b) *Method.*

1. From a suitable point, measure off 500 yards across smooth terrain; place men at 100 yard intervals and have them take concealed positions. As an introduction, the men undergoing instruction are told that they will have an opportunity to study the appearance of men at various ranges.
2. On signal, have all men stand. Then instruct the group to observe the gradual disappearance of detail (facial features, helmet, belt, rifle, hands, and leggings), and the fact that men seem to get smaller and smaller as the distance increases. Then call attention to distances at which various details vanish.
3. On signal, have the posted men kneel. Have the group study the appearance of the posted men. The instructor calls attention to the fact that the details fade at shorter ranges than they did when the posted men were standing.
4. On signal, have the posted men take up prone firing positions with rifles aimed at the group. Have the group study the appearance of the posted men. The instructor again calls attention to the fact that the details fade at even shorter distances than they did when the posted men were in the standing or kneeling position.
5. This exercise should be conducted both looking into the sun and away from the sun.

SECTION III

TARGET DESIGNATION

■ 171. *IMPORTANCE.*—Target designation is a vital element in technique of fire. Battlefield targets are generally so indistinct that leaders and individuals must make every attempt

to designate their location and extent carefully and accurately. Enemy troops will usually be so well concealed that the location of most individuals of the hostile unit will not be visible. To cover such a target, squad leaders must be able to designate the area in which hostile troops are located, and members of the squad must be trained to place heavy fire on the designated area even though no specific targets are visible.

■ 172. TOPOGRAPHICAL TERMS.—Prior to instruction in target designation, riflemen should understand the topographical terms normally employed in designating targets; for example, crest, military crest, hill, cut, ridge, bluff, fill, ravine, cross-roads, road junction, road center, road fork, skyline, etc., (fig. 51).

■ 173. TARGET DESIGNATION.—*a. General.*—(1) A complete target designation includes the following elements:

- (a) Range (how far to look).
- (b) Direction (where to look).
- (c) Description (what to look for).

(2) These elements are always given in the above sequence, with a slight pause between elements. An exception to this rule occurs when the target is expected to be visible for a short time only. In such cases, the target is pointed out as quickly as possible with a brief oral description as, for example, "Those men."

b. Range.—Range tells the man *how far* he must look to see the target when the direction is announced. It is announced first so that the man may set his sights and be ready to fire as soon as the two remaining elements of target designation are given and understood. It may be given either by voice or by arm-and-hand signal, and is determined by visual estimation or by observing the strike of bullets on the ground or the path of tracer bullets.

c. Direction.—Direction tells the man *where* to look, and may be indicated in the following three ways, or combination thereof:

(1) *Orally.*—The terms *front* (left front, right front, left flank, right flank, left rear, right rear, and rear) may be used to indicate the general direction of the target (fig. 52).

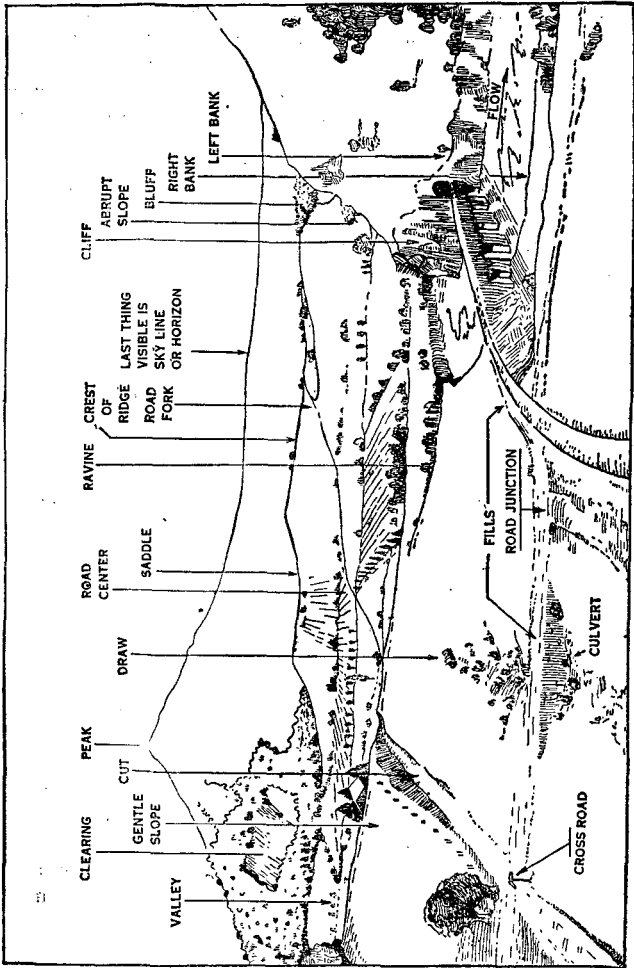

FIGURE 51.—Military terms for terrain features.

(2) *Pointing.*—In pointing, either the arm or rifle may be used. When using the rifle to indicate the direction to a target, cant the rifle to the right and aim it at the target; without moving the rifle, move the head to the left so as to permit the man behind the rifle to look through the sights and locate the target. If time permits, a bayonet may be stuck diagonally into the ground to serve as a rest for the rifle in order to keep it in place after it is laid on the target.

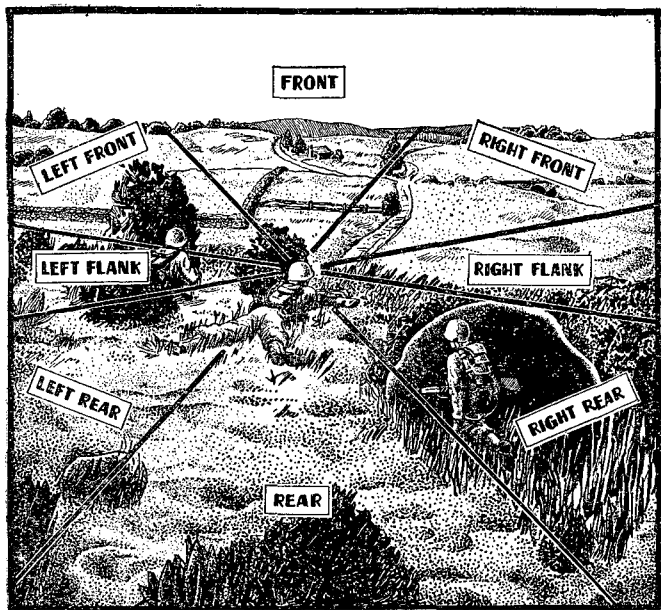

FIGURE 52.—Target designation—general directions.

In lieu of the bayonet, a log, the crotch of a tree, or any other suitable rest may be used; or the automatic rifle may be pointed, using the bipod as a rest.

(3) *Tracer bullets.*—The use of tracer bullets is a quick and sure method of indicating the direction to an indistinct battlefield target and the most accurate method of indicating the flanks of an obscure target. Their use is invariable

when scouts or other members of the squad are already under fire, when the squad is separated and out of voice-range of the leader, or when cover is scarce so that the movement required for pointing out the target will expose personnel to hostile fire. Designating a target by tracers, notwithstanding its advantages, has certain handicaps in that it discloses the position of the firer and at the same time lessens the surprise effect of a sudden burst of fire laid on the enemy position. Before firing tracers, it is helpful to indicate the general direction of the target orally in order that the squad members will be sure to look in the required direction and that they will be able to pick up the flight of the tracers.

d. Description.—Description tells the man *what* he is expected to see as well as the nature of his target—whether it is a point, linear, or oblique target, or one which extends in depth. Though oral designation is often used, battlefield conditions will rarely permit a leader thus to designate a target directly to all members of his unit. Therefore, when a scout or leader has preceded the squad, he frequently announces, “Range 500, right front, watch my tracer,” and fires a tracer at the target. He then describes the target, for example, “machine gun.” To designate a linear target, a scout or leader indicates its limits by firing tracers at each flank. He also announces or signals any range or windage correction obtained by tracer firing.

e. Examples.—The simplest form of target designation is the most effective. The adopted method should be the one best suited to the conditions existing at the time the target appears. Troops must be trained to use all methods. The following examples illustrate how several types of targets may be designated in specific situations:

(1) *Target plainly visible, or near an easily recognized object or terrain feature.*

Range 425.

Left front.

Sniper at base of dead tree (point marked A in fig. 53).

(2) *Target invisible, indistinct, or not located near an easily recognized object or terrain feature.*—The direction to the target is indicated by the use of a reference point. The

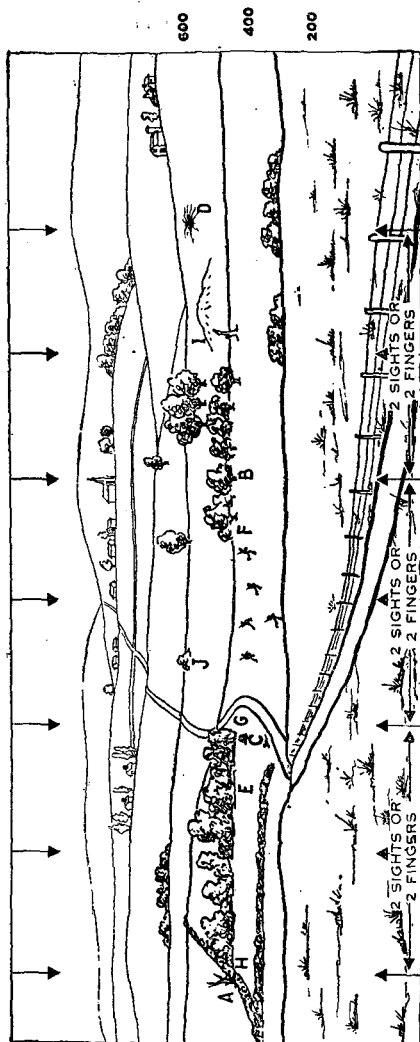

FIGURE 53.

selected reference point should be capable of being easily identified to members of the squad concerned, and should not be subject to being mistaken for a similar nearby object or point. A reference point on line with and beyond the target will give greater accuracy than one located between the observer and the target. The selected reference point should be as near to the target as practicable in order that the target may be quickly and easily picked up by all members of the squad. For brevity, a reference point when used in target designation is called "reference."

(a) *Reference point on line with target:*

Range 450;

Front;

Reference: church spire;

Target: machine gun in edge of woods (fig. 53, target at B).

It will be noted that the range announced is that to the target and not to the reference point. When the word "reference" is used, the word "target" is also used to differentiate between the two objects. Another example follows—

Range 350;

Left front;

Reference: black stump;

Target: sniper on far side of road (fig. 53, target at C).

(b) *Reference point not on line with target.*—1. The interval to the right or left between the reference point and the target is measured in units called "fingers." If the hand is held so that the left edge of a finger is on line with the reference point and the right edge of that same finger is on line with the target, the target is one finger width to the right of the reference point; this interval is announced as "Right, one finger." If two fingers can be applied to this lateral interval, it is announced as "Right, two fingers." The following additional examples refer to figure 53 and illustrate this method:

(Target at D)—

Range 600;

Front;

Reference: church spire; right, two fingers;

Target: group of enemy in shell hole near crest;

(Target at E)—

Range 425;

Left front;

Reference: dead tree; right, one and one-half fingers;

Target: sniper in edge of woods.

(Target at F)—

Range 450;

Front;

Reference: church spire; left, one-half finger;

Target: machine gun in corner of woods.

2. The width or extent of targets is also measured in fingers (target G to H):

Range 425;

Front;

Reference: church spire; left, two fingers;

Target: enemy groups in edge of woods extending left, two fingers.

(c) *Successive reference points.*—These may be used instead of finger measurements from one reference point (target at I):

Range 500;

Front;

Reference: church spire; to the right and at a shorter range, a group of three trees; to the right and at the same range;

Target: machine gun at left end of mound of earth.

(d) *Combination of successive reference points and fingers may be used.*—Example (target at J):

Range 600.

Front.

Reference: church spire; to the left and at a shorter range, lone tree; left one finger and at the same range.

Target: machine gun in clump of brush.

f. *Variations.*—If one end of a target is considerably nearer than the other, the average range is announced since dispersion will cover the target. Battlefield conditions will impose many practical substitutions and combinations of methods in target designation. Frequently the squad leader will be able to designate the target to only one or two members of his squad. Therefore, each member of the squad

must be taught to assist in designating the targets to other members of the squad team. At times the entire target designation will be furnished by the scouts to other members of the squad as they arrive in the vicinity. Formal, long-winded oral target designation will often confuse more than help.

■ 174. EXERCISES.—*a. No. 1.*—(1) *Purpose.*—To teach the use of fingers for lateral measurement.

(2) *Method.*—(a) A number of short vertical lines 1 foot apart are plainly marked on a wall or other vertical surface (fig. 54). At a distance of 20 feet from the wall, a testing line is drawn or marked out by stakes. The instructor explains that the vertical lines are one finger (50 mils) apart when measured from the testing line, and are used for the purpose of determining the correct distance from the eye that the index finger must be held so that it will cover the space between one of the vertical lines and the next line to the right or left.

(b) The instructor then explains and demonstrates the use of the index finger in lateral measurement. First he holds his hand, with palm to the rear and finger pointing upward, at such a distance from his eye that the finger will cover the space between one vertical line and the next line to the right or left. Then he lowers his hand to his side without changing the angle of the wrist or elbow and notes the exact point at which the hand strikes the body. Thereafter, when measuring with the finger, he first places his hand at this point and raises his arm to the front without changing the angle of the wrist or elbow. His hand will then be in the correct position for measuring fingers. The men then determine the proper distance of the finger from the eye as explained by the instructor. The men should then practice until they know exactly how far from the eye to hold the finger. When proficient, this should be done without reference to the point where the hand touched the body, so they can use the finger measurement from any position. The instructor explains that the one finger measurement may be repeated or two or three fingers may be used in measuring intervals between points.

(c) Using convenient objects within view, practice in making lateral measurement is given.

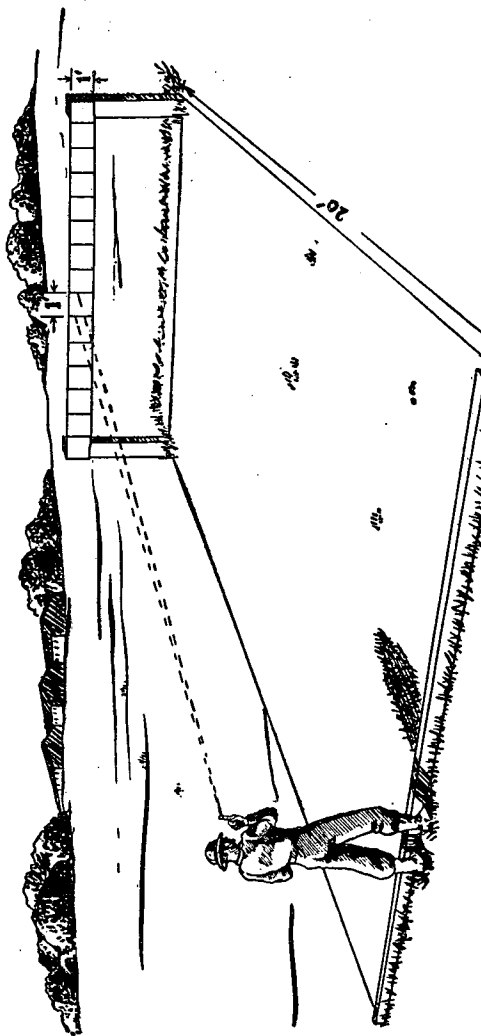

FIGURE 54.—Finger calibration court.

b. No. 2.—(1) *Purpose*.—To afford practice in target designation (indicating direction by oral description).

(2) *Method*.—(a) The squad is deployed and faced to the rear. The squad leader is at the firing point, where sandbags or bayonet rests have been provided for each rifle.

(b) At a prearranged signal, the target is indicated by displaying a flag, by firing a burst of blank cartridges from a machine gun, or by other suitable ballistic means. When the squad leader states that he understands the nature and position of the target, the flag is withdrawn.

(c) The squad is then brought to the firing point and placed in the prone position. The squad leader, also in the prone position, estimates the range and gives his designation. Each man is required to set his sight, use the sandbag or bayonet rest, and sight his rifle on the point at which he believes the target is located.

(d) The instructor checks the designation given by the squad leader from a position similar to that assumed by the squad leader. The men are required to leave their rifles on the rests, properly pointed, until verified by the instructor or squad leader.

(e) After the rifles have been checked, the flag is waved again or another burst of blanks is fired so that all men may be given an opportunity to check on their knowledge as to the location of the target.

c. No. 3.—(1) *Purpose*.—To afford practice in target designation (indicating direction by pointing with the rifle).

(2) *Method*.—(a) The squad is formed faced to the rear. The instructor then points out the target to the squad leader who takes the kneeling or prone position, estimates the range, adjusts the rear sight, alines his sights on the target, and then calls "Ready."

(b) The members of the squad then move in turn to a position directly behind the squad leader and look through the sights until they have located the target. The range and a brief description of the target are given orally by the squad leader to each individual.

(c) As soon as each man has located the target he moves to the right or left of the squad leader, sets his sight, places

his rifle on a bayonet rest or sandbag, and alines his sights on the target.

(d) The instructor, assisted by the squad leader, verifies the sight setting and the alinement of the sights of each rifle.

d. No. 4.—(1) Purpose.—To afford practice in target designation (indicating direction by firing tracer bullets).

(2) *Method.*—(a) A concealed target representing a machine gun is placed near a pit or other bulletproof shelter. About 500 yards in front of the target, a firing position suitable for a squad is selected. The location of the target will be visible from the firing position but the target itself may be invisible because of its concealment. This concealment should have a natural appearance in order not to attract attention.

(b) The squad is deployed along the firing position and all except the scouts are then faced to the rear.

(c) The scouts take the prone position and are told that the waving of a red flag to their front will represent the firing and smoke from the machine gun.

(d) A man stationed in the pit waves a flag in front of the target for about 30 seconds and retires to the protection of the pit. In lieu of the red flag, a machine gun inside a pit at the target location may be fired.

(e) The squad is faced to the front and men take the prone position with their rifles loaded and locked. The scouts use tracer ammunition and the remainder of the squad use ball cartridges.

(f) One scout estimates the range and adjusts his rear sight, alines his sights on the target, and opens fire. He adjusts his sights by increasing or decreasing his elevation as directed by the other scout who observes the fire. Thus having determined the correct range, the scouts have identified the target for the remainder of the squad. The scouts then announce the range which is passed orally from man to man.

(g) As soon as each man understands the location of the target, he opens fire with the proper sight setting.

(h) The instructor causes firing to cease shortly after all men commence firing.

(i) Noncommissioned officers do not participate in the fire.

Squad leaders move about freely behind their men and observe the firing. The assistant squad leader assists the squad leader.

(j) After firing ceases, sight settings are checked by the squad leader and the target is examined or the hits are signaled to the squad.

SECTION IV

AUTOMATIC RIFLE FIRE AND ITS EFFECT

■ 175. **TRAJECTORY.**—*a. Nature.*—The trajectory is the path followed by a bullet in its flight through the air. Using M2 armor-piercing ammunition, the bullet leaves the automatic rifle at a speed of 2,775 feet per second. Because of this great speed the trajectory at short ranges is almost straight or flat.

b. Danger space.—The space over level or uniformly sloping ground between the rifle and the target in which the trajectory does not rise above a man of average height is called the "danger space." The trajectory for a range of 750 yards does not rise above 68 inches. Therefore, it is said that the danger space over level or uniformly sloping ground for that range is continuous between the muzzle of the gun and the target. For ranges greater than 750 yards, the bullet rises above the height of a man standing, so that only part of the space between the gun and the target are danger spaces (fig. 55).

■ 176. **DISPERSION.**—Because of differences in ammunition, aiming, holding, and wind effects, a number of bullets fired from an automatic rifle at a target are subject to slight dispersion. The trajectories of those bullets form a cone-shaped figure (fig. 56) called the "cone of dispersion."

■ 177. **SHOT PATTERNS.**—The pattern formed by the cone of dispersion on a vertical target is narrow in width and the height of the pattern is slightly longer than the width. Because of the flatness of the trajectory, the pattern formed by the cone of dispersion on a horizontal target is much greater in length than in width. On level ground the length

(H=MAXIMUM ORDINATE - HIGHEST POINT OF TRAJECTORY)

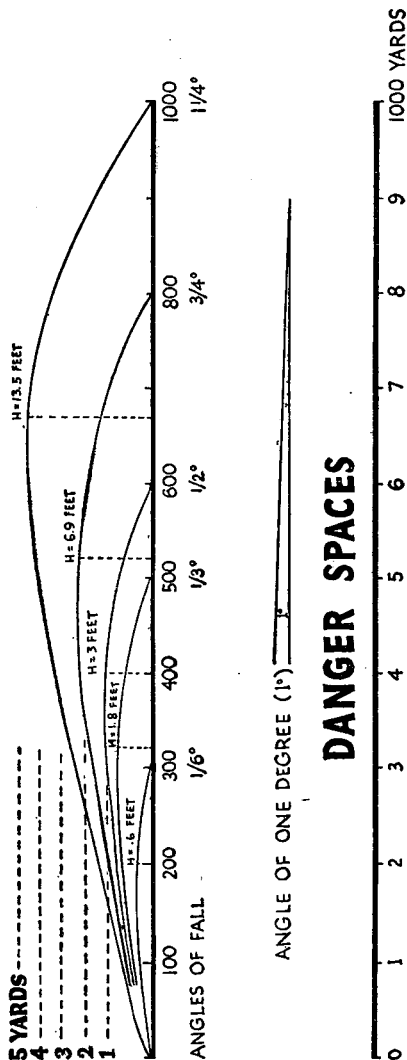

DANGER SPACES

CONTINUOUS TO 750 YARDS

800 YARDS

1000 YARDS

Figure 55.—Trajectory and danger space diagram for M2 armor-piercing ammunition. (Vertical scale is approximately 27 times horizontal scale.)

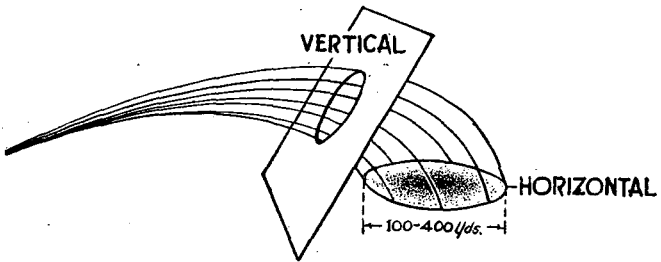

FIGURE 56.—Cone of dispersion, vertical and horizontal shot patterns.

of the horizontal pattern varies in length from 100 yards at the longer ranges to 400 yards at short ranges.

■ 178. **BEATEN ZONE** (fig. 57).—The beaten zone is the area on the ground struck by the bullets. The slope of the ground therefore has great effect on the shape and size of the beaten zone. Rising ground shortens the beaten zone. Ground that slopes downward and in the approximate curve of the trajectories will greatly lengthen the beaten zone. Falling ground with greater slope than the trajectory will escape fire and is said to be in defilade.

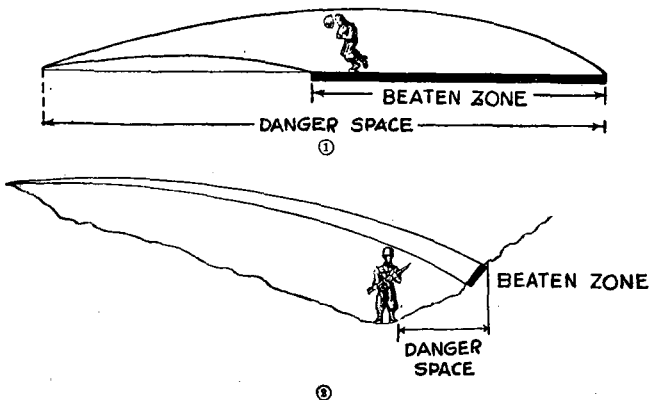

FIGURE 57.—Grazing and plunging fire showing beaten zone.

■ 179. CLASSES OF FIRE.—*a.* According to direction, fire is classified as follows (fig. 58):

(1) *Frontal*.—Frontal fire is fire delivered at right angles to the front of the objective. It is least effective against a target shallow in depth, such as a line of skirmishers, because it fails to take advantage of the depth (length) of the beaten zone. It is most effective against targets which are narrow and deep, for example, a column of squads approaching the rifle.

(2) *Flanking*.—Fire delivered against the flank of a target is called flanking fire. This type of fire (except for its surprise and morale effect) is not very effective against the flank of column targets of small width, because only a small part of the target will be covered by the narrow beaten zone of the automatic rifle fire. However, flanking fire is very effective against a line target such as a skirmish line, for here, the long axis of the target coincides with the long axis of the beaten zone.

(3) *Oblique*.—Fire delivered from a direction oblique to the long axis of the target is called oblique fire.

(4) *Enfilade*.—Enfilade fire is fire, either frontal or flanking, in which the long axis of the beaten zone coincides with the long axis of the target. It is the most effective type of fire. Columns of approaching troops engaged from the front, or line targets engaged from positions on their flanks, are said to be taken in enfilade.

b. According to trajectory, fire is classified as follows:

(1) *Grazing* (fig. 57[ⓐ]).—Grazing fire is that fire which

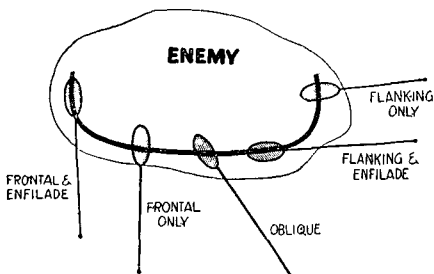

FIGURE 58.—Classes of fire with respect to target.

does not rise above the height of a man standing. Where the automatic rifle is fired from the prone position, the trajectories of the bullets at ranges up to 750 yards, over level or uniformly sloping ground, produce grazing fire.

(2) *Plunging*.—Plunging fire (fig. 57②) is fire in which the bullet's angle of fall with reference to the slope of the ground is such that the danger space is practically confined to the beaten zone. The length of the beaten zone is materially lessened. Fires delivered from high ground on ground lying approximately at right angles to the cone of fire, or against ground rising abruptly to the front with respect to the position of the rifle, are examples of plunging fire (fig. 57②). As the range increases, fire becomes increasingly plunging, because the angle of fall of the bullets becomes greater.

(3) *Overhead*.—Overhead fire is fire delivered over the heads of friendly troops, and may be employed when the conformation of the ground is such that the fire will not be dangerous to friendly troops.

■ 180. EFFECT OF FIRE.—*a.* Automatic riflemen secure the most decisive results when close to the enemy. The entire squad usually holds its fire until the range to the target is 500 yards or less. However, under favorable conditions, the automatic rifle is effective against enemy troops or areas known to contain enemy groups at ranges between 500 yards and 1,000 yards, the effectiveness of the fire being about the same as that of the light machine gun under the same conditions.

b. Automatic rifle fire is effective and should be used against low-flying planes. It can be used effectively against tanks to cause the crew to keep doors and shields closed. When armor-piercing ammunition is used, the fire is effective against lightly armored vehicles and concrete emplacements, as well as personnel.

c. Fire may be continued when the morale effect and hazard are sufficient to keep the enemy under cover, render his fire ineffective, and maintain fire superiority. However, when opposing forces are entrenched and neither is trying to advance, fire for morale effect alone is worthless.

■ 181. EXERCISE.—*a. Purpose.*—To show trajectories.

b. Method.—(1) The unit under instruction watches the firing of a few tracer bullets at targets the ranges to which are announced. Ranges of 300, 600, and 800 yards are suitable selections. The flatness of the trajectories is called to the attention of the men.

(2) The automatic riflemen fire several bursts of tracer bullets at the slow cyclic rate to acquaint the unit under instruction with the cone of fire made by the trajectories of the automatic rifle.

SECTION V

APPLICATION OF FIRE

■ 182. GENERAL.—*a. Means of action.*—Rifle units have two general means of action—fire and movement. Fire, movement, and hand-to-hand fighting are combined in the combat action of the squad and larger units. The application of fire by such units is essential to their success.

b. Application of fire.—(1) *In attack.*—The squad and smaller groups must be trained to place a large volume of accurate fire upon probable enemy locations and indistinct or concealed targets such as enemy machine guns or small groups. The squad and smaller groups must be trained to apply such fire quickly upon order or signal of their leader and, in appropriate circumstances, to apply it without such order. During the fire fight, the primary duty of the squad leader is to place the fire of his squad on the target. In accomplishing this, he keeps in mind the fire power of the automatic rifle team which he employs within the squad to place automatic fire on suitable targets and to support the advance of other members of the squad (figs. 59 and 60). For this reason he selects positions for the automatic rifleman from which he can deliver effective fire on any target holding up the remainder of the squad. When practicable this position should permit the automatic rifle to cover the entire squad front. The selected position will usually be the one with the best field of fire.

(2) *In defense* (figs. 61 and 62).—In defense, the fire of a small rifle unit such as a squad is delivered by small groups

and individuals from positions which they must hold. The automatic rifle team is placed where it can obtain the best field of fire, and at the same time take advantage of cover and concealment. Consideration should also be given to placing it where it will be able to assist adjacent units. The automatic rifle can be used to establish a final protective line by the grazing fire method outlined in paragraph 239. The possibility of such use should be considered in selecting the position for the automatic rifle.

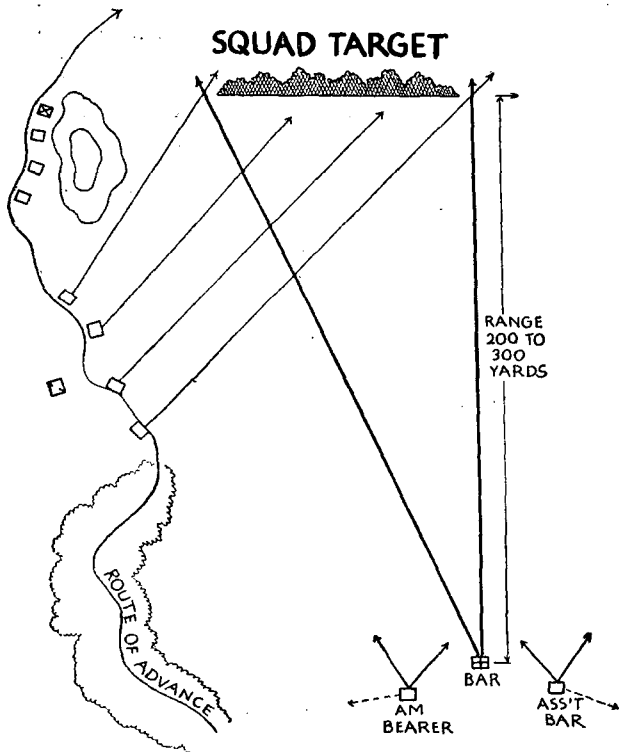

FIGURE 59.—Diagram showing use of automatic rifle to support advance of the riflemen of the squad. (Four of the riflemen are firing to give additional fire support while the remainder of the squad continues the advance.)

(3) *In delaying actions.*—Because of its high mobility and fire power, the automatic rifle is particularly adapted to use in delaying actions to harass the enemy and to cover road blocks, stream crossings, and defiles. To cover these with fire, a well trained automatic rifle team should take advantage of opportunities to fire from position defilade as described in paragraph 240.

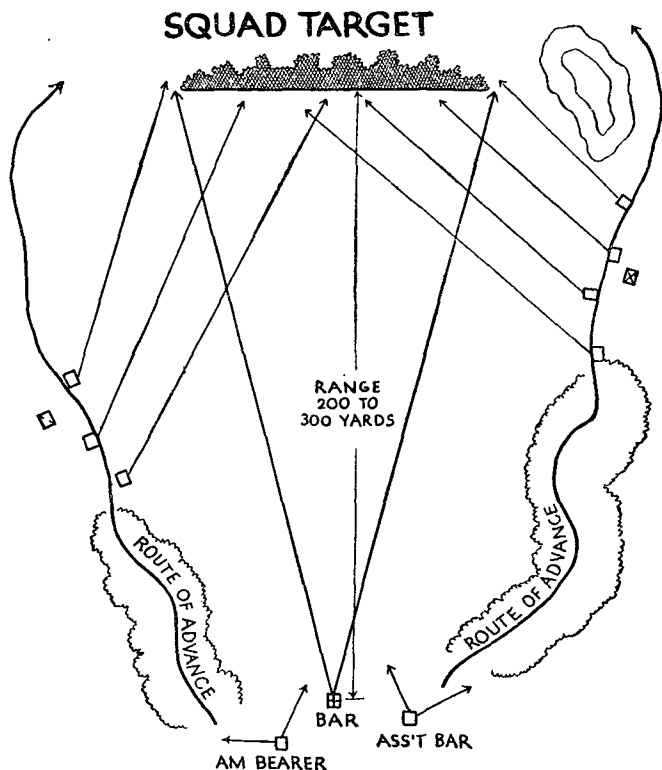

FIGURE 60.—Diagram showing use of automatic rifle to support advance of the riflemen of the squad. (The riflemen are divided into two groups, one on each flank. One group fires to support the advance of the other; or the groups alternately fire and advance, each supporting the advance of the other.)

c. Actions of members of automatic rifle team.—The automatic rifle team is a fire unit within the rifle squad. This team should be kept together and duties alternated in all phases of training so that each member knows all the duties of the other members, thus insuring that the fire power of this weapon will not be materially affected by battle casualties.

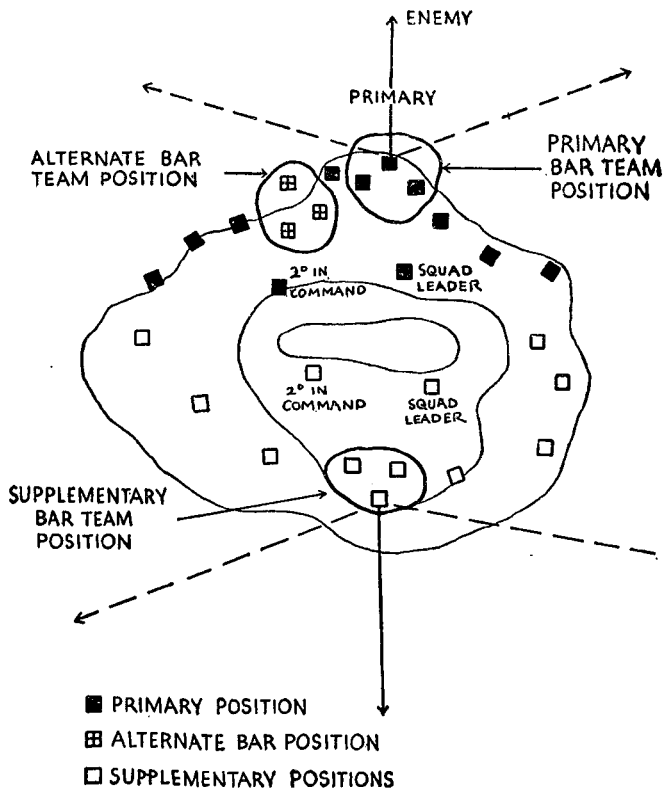
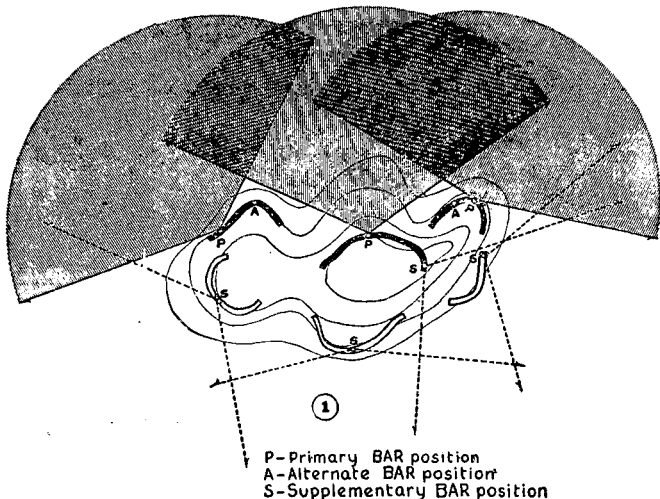

FIGURE 61.—Diagram of a squad in a defensive position showing the location of the automatic rifle team in primary, alternate, and supplementary positions.

(1) The automatic rifleman receives orders from the rifle squad leader or the assistant squad leader. Pursuant to such orders, he takes position and brings under fire any designated targets and such targets of opportunity as may present themselves. He is ever watchful for opportunities to further the advance of the remainder of the squad by the timely use of the fire power of his automatic weapon.

(2) The assistant automatic rifleman takes position so that he can see the target, the squad leader (or assistant squad leader), and the automatic rifleman. He aids the automatic rifleman in getting on the target, transmits to him orders and signals from the squad leader (or assistant squad leader), observes for new targets, assists the automatic rifleman in the reduction of stoppages, and replaces

ENEMY



① Automatic rifle sectors of fire.

FIGURE 62.—Diagram of a platoon in a defensive position showing location of automatic rifle teams to support adjacent squads, the location of alternate and supplementary positions, and the coordination of the fires of the automatic rifles with the squad sectors of fire.

him should he become a casualty. When necessary, he participates in the fire with his rifle.

(3) The ammunition bearer's primary duty is to keep the automatic rifleman supplied at all times with ammunition. When he is not engaged in supplying ammunition he performs the duties of a rifleman, and promptly engages those targets which threaten the automatic rifle. He also aids the assistant automatic rifleman in carrying out his duties and assumes the duties of the automatic rifleman in case both the automatic rifleman and assistant automatic rifleman become casualties.

d. Requirements of position.—In the occupation of a firing position, the location of squads in the platoon area should be made with due regard to the following requirements:

- (1) Suitability for desired fire support.
- (2) Field of fire to the front.
- (3) Maximum use of available cover and concealment.
- (4) Fire control by unit leader.

ENEMY

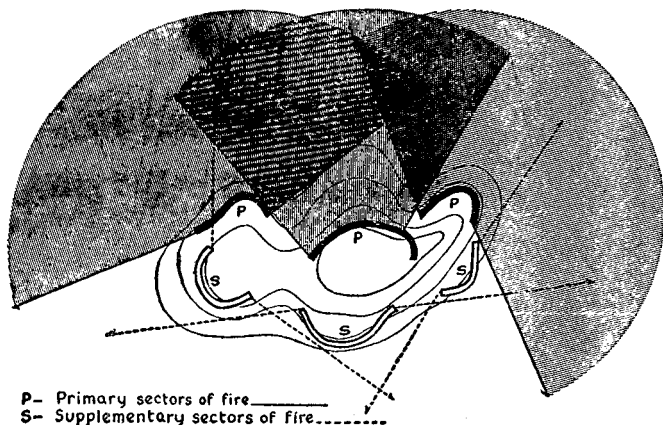

② Squad sectors of fire.

FIGURE 62—Continued.

When these requirements conflict, it is the duty of leaders to weigh the importance of each and make the best dispositions.

■ 183. **CONCENTRATED AND DISTRIBUTED FIRE.**—The size and nature of the target presented may call for the fire power of the entire group or only certain parts. The fire of a group must necessarily be either concentrated or distributed fire.

a. Concentrated fire.—Concentrated fire is fire directed at a single point. This fire is very effective. Machine guns and other crew-served weapons are examples of suitable targets for concentrated fire.

b. Distributed fire (fig. 63① and ②).—(1) Distributed fire is fire distributed in width for the purpose of keeping all parts of the target under effective fire. It is habitually used on targets having any considerable width.

(2) The method of fire distribution employed by a squad

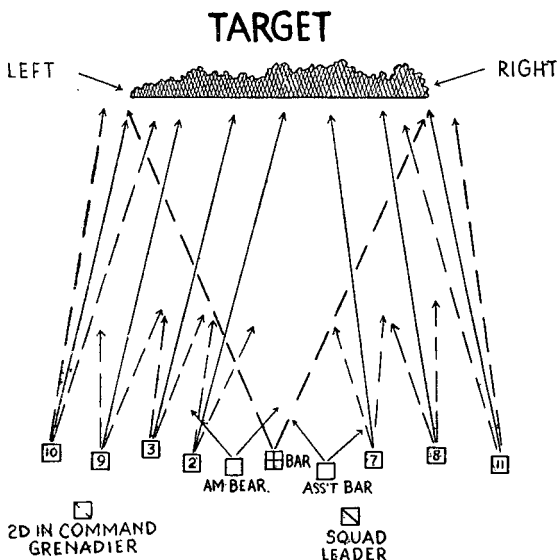

① Automatic rifle team centrally located, No. 11 on the flank.

FIGURE 63.—Squad fire distribution.

is as follows: Each rifleman fires his first shot on that portion of the target corresponding generally to his position in the squad. He then distributes his remaining shots to the right and left of his first shot, covering that part of the target on which he can deliver accurate fire without having to change position. The amount of target each rifleman can cover will depend upon the range and the position of the firer. In some cases each rifleman will be able to cover the entire target with accurate fire. Fire is not limited to points known to contain an enemy; on the contrary, riflemen space their shots so that no portion of the target remains unmolested. This does not mean that rifleman or automatic riflemen try to cover every square foot of the target area, but rather that each rifleman searches the sector which he can cover and fires wherever and whenever he actually sees an enemy. He also fires at each likely spot where an enemy might be concealed. The flank men are taught to overlap the flanks of

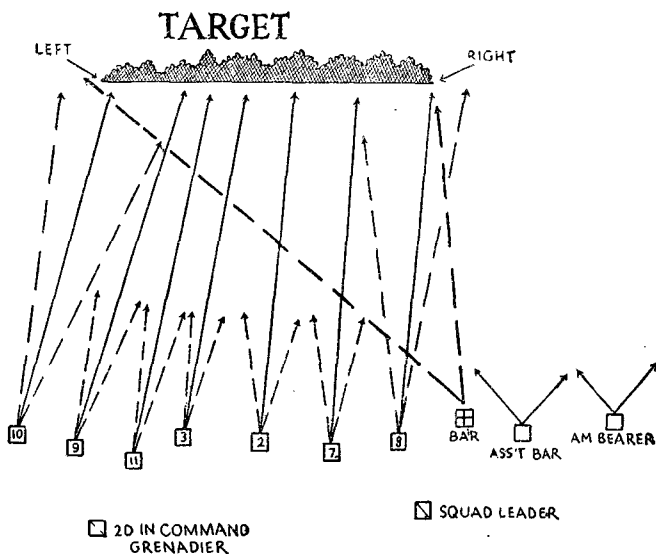

FIGURE 63—Continued.

the target slightly to be sure that both flanks are covered. This method of fire distribution is employed without command. It enables squad leaders to distribute the fire of their units so as to cause the entire target to be kept under fire.

(3) From a position best suited to provide support, the automatic rifleman distributes his fire over the entire target, or on any target which will best support the advance of other members of the squad. The automatic rifleman, his assistant, and the ammunition bearer function as a team in order to keep the automatic rifle in a state of constant readiness for action.

(4) If a squad is employing this method of fire distribution and other targets appear, the squad leader announces such changes in the fire distribution as are necessary.

(5) When a target can be engaged by the entire platoon and is narrow in width, each squad engages the entire target. When this is impracticable, the platoon leader assigns a portion of the target to each squad.

■ 184. ASSAULT FIRE.—Assault fire is that fire delivered by a unit during its assault on a hostile position. Riflemen with bayonets fixed, and the automatic rifleman, his assistant, and the ammunition bearer, taking full advantage of existing cover, such as tanks, boulders, trees, walls, and mounds, walk rapidly toward the enemy and fire as they advance at areas known or believed to be occupied by hostile personnel. Such fire is usually delivered from the standing position and is executed at a rapid rate. This fire may also be delivered from the hip or any other convenient position. The automatic rifleman fires from the assault fire position (fig. 24) and at a rapid rate.

■ 185. RATE OF FIRE.—The automatic rifleman fires at the rate of fire most effective under existing conditions. He therefore determines the rate of fire to use by considering the type of fire (frontal, oblique, enfilade), the size of the target, the proximity (range) of the target, and the available supply of ammunition. The maximum rate at which the automatic rifle should be fired is determined by the speed and ability of the gunner to align the sights and press off accurate bursts. To exceed this rate is a waste of ammunition. Con-

siderable skill is required to fire single shots. The accuracy of this fire is the same as that of a rifle. When bursts of 2 or 3 rounds are fired, there is a small loss in accuracy when compared to single shot firing. A longer burst causes dispersion of the shots in depth. Hence the size of the burst is determined by the type of target on which fire is to be placed. In the case of frontal fire without enfilade effect, bursts of 2 or 3 rounds are the most effective to use. Against compact targets or small areas known to contain compact groups and against targets taken in enfilade, bursts of 4 or 5 rounds should be used. Where a long target is taken in enfilade, a skilled automatic rifleman, by aiming initially at the near end of the target, can fire a burst of 20 rounds and obtain good fire effect. At ranges beyond 600 yards, bursts of 2 or 3 rounds should be used when accuracy of fire is necessary. The initial burst may be long in order to provide observation of the strike of the bullets. To obtain the element of surprise, the first few bursts should be delivered at the maximum rate in order to pin the enemy to the ground. Thereafter, the rate of fire should be slowed down to a rate which is just sufficient to maintain fire superiority. This allows for adjustment of the fire by the squad leader and conserves ammunition.

■ 186. FIRE DISCIPLINE.—*a.* Fire discipline implies the careful observance of instructions relative to the use of the rifle and automatic rifle in combat, and exact execution of the orders of the leader. When fire discipline is good, men fight as they have been trained to fight and obey orders promptly and carefully; they resist and overcome the influence of danger, excitement, and confusion. Fire discipline is necessary for proper control by leaders; teamwork and effectiveness of the collective fire of the unit depend upon this control. The training necessary to insure good fire discipline cannot be completed during the brief period devoted to technique of fire. Training in fire discipline starts with the soldier's first drill and continues throughout his military training. Any drill or exercise which develops alertness and the habit of obedience or other soldierly qualities will aid in developing the character essential to fire discipline.

b. Fire discipline is maintained by leaders chiefly by their example of coolness and courage. Replacement of casualties is an element of fire discipline which keeps the unit working as a team in spite of losses. If any group finds itself without a leader, it is essential for one of the group to assume leadership and carry out the assigned mission or attach the group to the nearest organized unit. An individual separated from his squad fights on his own initiative only when he has reason to believe that his single effort will accomplish some important result. Otherwise he reports to the nearest leader at once.

c. Fire discipline in the squad is the responsibility of the squad leader; he is assisted by the assistant squad leader. The position of the squad leader during the fire fight will be where he can best control his squad. The assistant squad leader will be where he can best assist the squad leader.

■ 187. FIRE CONTROL.—*a. General.*—Fire control consists of the initiation and supervision of the fire of a unit or group by its leader. It implies the ability of the leader to have his men open fire or cease fire at the instant he desires, to adjust the fire upon the target, to shift all or a part of the fire from one target to another, and to regulate the rate of fire. Fire control pertains chiefly to the squad or smaller group. The leader of the squad or smaller group must supervise and control the fire of his men so that it is directed and maintained at suitable targets. All must understand that controlled fire is always the most effective fire. On the other hand, the irregular formations adopted for an advance will often render such control impracticable. In such case, fire must be opened and maintained on the initiative of individuals, as circumstances require. However, the leader should seek to regain control of the fire of his men at the first opportunity.

b. How exercised.—Squad leaders and assistant squad leaders exercise fire control by means of orders, commands, and signals. The signals most frequently used are—

Signals for range.

Commence firing.

Fire faster.

Fire slower.

Cease firing.
 Are you ready?
 I am ready.
 Fix bayonets.

■ 188. FIRE ORDERS.—*a. Purpose.*—The leader of a rifle fire unit or group of riflemen, having made a decision to fire on a target, must give certain instructions as to how the target is to be engaged. The instructions by which the fire of a squad is directed and controlled form the fire order.

b. Basic elements.—A fire order contains three basic elements which are announced or implied in every case. Only such elements or parts thereof will be included as are essential. Except when the squad is to engage more than one target, in which case the fire distribution element may be given first, the sequence is always as follows:

Target designation element.

Fire distribution element.

Fire control element.

(1) *Target designation element.*—The target may be designated by any one or a combination of the prescribed methods. This element tells where the target is and what it is (par. 173).

(2) *Fire distribution element.*—This tells who is to fire. It may be omitted from the fire order when all members of the squad are firing at the same target. The method of fire distribution described in paragraph 183*b* is habitually employed against targets of width in the absence of instructions to the contrary. When necessary to engage more than one target, the fire distribution element includes the subdivision of the target. In this case, the fire distribution element may be given first.

(*a*) A squad leader desires to engage two machine-gun nests; the fire distribution element of his order might be as indicated by the italicized words below:

Cooper, Emerson, Crane, Hines, Turner (riflemen).

Range 400.

Front.

Machine gun at base of lone pine.

Brown (automatic rifleman), Smith, Jones, Howard, Stone (riflemen).

Range 500.

Left flank.

Machine gun at base of haystack.

(b) The squad leader may engage two targets by placing a number of riflemen under the command of the assistant squad leader, directing him to engage one target, while he (the squad leader) engages the other target with the automatic rifleman and other members of the squad; or, the squad leader may place the automatic rifleman and certain members of the squad under the assistant squad leader to engage one target, while, with remaining members of the squad, he (the squad leader) engages the second target.

(3) *Fire control element.*—(a) The fire control element normally consists of only the command or signal **COMMENCE FIRING**. It tells when to fire. It may also include the number of rounds and, for the automatic rifle, may include the number of bursts or the number of rounds in the burst or both. Examples are:

EIGHT ROUNDS, **COMMENCE FIRING**.

ONE (TWO OR MORE) MAGAZINE(S), **COMMENCE FIRING**.

BURSTS OF TWO (THREE, FOUR, OR MORE), **COMMENCE FIRING**.

TWO BURSTS OF TWO (THREE, FOUR, OR MORE), **COMMENCE FIRING**.

(b) An example of a complete fire order follows:

1. *Target designation element.*

(Range) _____ Range 600.

(Direction) _____ Front (left front, etc.).

(Description of target) _____ Group of enemy.

2. *Fire distribution element.*— (Implied.)

3. *Fire control element.*— Commence firing.

c. *Surprise fire.*—To secure the maximum surprise and shock effect, it is important that all weapons of a unit open fire at the same instant. To insure this, the leader may preface the command or signal for commencing fire by the words "upon command" or "upon signal." Men are trained so that each one, as soon as he reaches a firing position and picks up his target, aims his rifle or automatic rifle at the target. As soon as the leader has determined that all men are in position and are aiming at the target, he gives the command or signal **COMMENCE FIRING**. In some situations,

the leader may delay in giving the command **COMMENCE FIRING** until the critical moment for opening fire is at hand. In this case, to insure that all men open fire at the same time, a sufficient pause is made between the words "commence" and "firing" to permit the men to realine their sights on the target and be ready to fire at the word "firing."

d. Other than surprise fire.—If surprise fire is not required, the command **COMMENCE FIRING** is announced immediately after the target designation element of the fire order. Each man then opens fire as soon as he is in a firing position and has picked up his target.

■ 189. **DUTIES OF LEADERS.**—The following summary of duties of leaders relates only to their duties in the technique of fire:

a. Squad leader.—(1) Carries out orders of platoon leader.

(2) Selects firing positions for squad.

(3) Designates targets and issues fire orders.

(4) Controls fire of squad, when possible.

(5) Maintains fire discipline.

(6) Observes targets and effect of fire.

(7) Directs the assistant squad leader to control the fire of a portion of the squad, when desirable.

b. Assistant squad leader.—(1) Carries out orders of squad leader.

(2) Assists squad leader to maintain fire discipline.

(3) Assumes command of squad in absence of squad leader.

(4) Participates in firing when the fire of his rifle is considered more important than other assistance to the squad leader.

(5) Controls any portion of the squad, as directed by the squad leader.

SECTION VI

LANDSCAPE TARGET FIRING

■ 190. **SCOPE AND IMPORTANCE.**—*a.* After satisfactory progress has been made in the preceding steps, the soldier may be given practice in the application of those lessons by firing at landscape targets.

b. The advantages of this training are as follows:

(1) Immediate supervision over all members of the firing

unit is made possible by their close proximity. The instruction is therefore more individual than would be otherwise possible.

(2) The accessibility and nature of the targets permit the application and effect of the fire to be shown in a minimum of time.

(3) This form of instruction lends itself to indoor training when lack of facilities or weather conditions make it desirable.

c. In circumstances where there is a choice between landscape target firing as covered in this section and field target firing as covered in section VII of this chapter, the latter is to be preferred. Firing at landscape targets is therefore not required as a part of training.

■ 191. DESCRIPTION OF TARGET.—A landscape target is a panoramic picture of a landscape and is of such size that all or nearly all of the salient features will be recognizable at a distance of 1,000 inches. The standard target is the series A target of five sheets in black and white.

■ 192. WEAPONS TO BE USED.—Firing at landscape targets should be with caliber .22 rifles, preferably the M1922M2 equipped with the Lyman receiver sight. When a sufficient number of these rifles are not available, the caliber .30, M1 and M1903 rifles, and the automatic rifle may be used.

■ 193. PREPARATION OF TARGETS.—*a. Mounting.*—(1) The target sheets are mounted on frames made of 1- by 2-inch dressed lumber, with knee braces at the corners. The frames for the target sheets are 24 by 60 inches. These frames are covered with target cloth which is tacked to the edges.

(2) The target sheets are mounted as follows: Dampen the cloth with a thin coat of flour paste and let it dry for about an hour; apply a coat of paste similarly to the back of the paper sheet and let it dry about an hour; apply a second coat of paste to the back of the paper and mount it on the cloth; smooth out wrinkles, using a wet brush or sponge and working from the center to the edges. The frame must be placed on some surface which will prevent

the cloth from sagging when the paper is pressed on it. A form for this purpose can easily be constructed. It must be of the same thickness as the lumber from which the frames are built and must have approximately the same dimensions as the aperture of the target frame.

b. Target frame supports.—Panels mounted on frames as described above are set in vertical frame supports consisting of posts (about 4 by 4 inches) of sufficient height, placed upright in the ground, 5 feet from center to center, with horizontal pieces of 2 to 4 inches to support the panels, braced to insure stability (fig. 64). The panels are supported by cleats and dowels in order to allow for easy removal.

c. Range indicators.—In order to make all elements of target designation complete, assumed ranges must be used on landscape targets. Small cards on which are painted appropriate numbers representing yards of range are tacked along one or both sides of a series of panels (fig. 64). The firers must be cautioned that the range announced in any target designation is for the sole purpose of designating the target, and that the sight setting necessary to zero their rifles must not be changed.

d. Direction cards.—In order to provide the direction element in oral target designation, small cards on which are painted "Front," "Right front," "Left front," "Right flank," and "Left flank," are tacked above the appropriate panels of the landscape series (fig. 64).

e. Scoring devices.—(1) Scoring the exercises will tend to create competition between squads and will enable the instructor to grade their relative proficiency. A scoring device for a point target (fig. 65), conforming in size to the 50- and 75-percent shot groups to be expected of average shots firing at 1,000 inches and at reduced ranges, can easily be made from wire. A better one may be prepared by imprinting a scoring diagram on a sheet of transparent celluloid. By using a scoring template constructed from celluloid, plywood, beaverboard, or any similar material, the scoring space can be outlined on the target in pencil before the target is shown to squad leaders (fig. 65). This procedure prevents any misunderstanding of squad leaders as

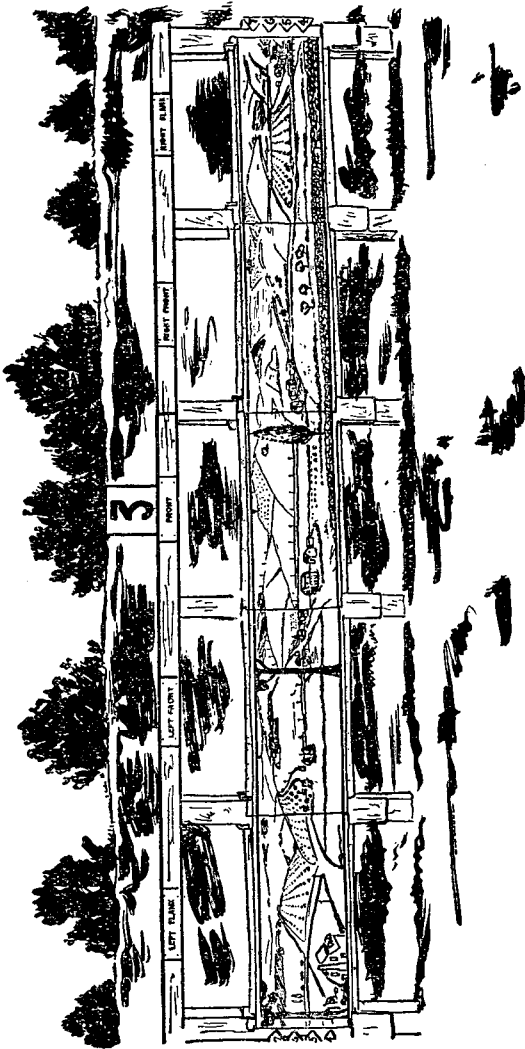

FIGURE 64.—Arrangement for setting up landscape target panels.

to the limits of the designated target. Upon completion of firing, the entire squad is shown the target and the results of the firing.

(2) While shot groups are in the form of a vertical ellipse, the 50- and 75-percent zones should be shown by the devices as rectangles. This is for convenience in their preparation. For a distance of 1,000 inches, the 50-percent zone is a rectangle 2½ inches high by 2 inches wide; the 75-percent

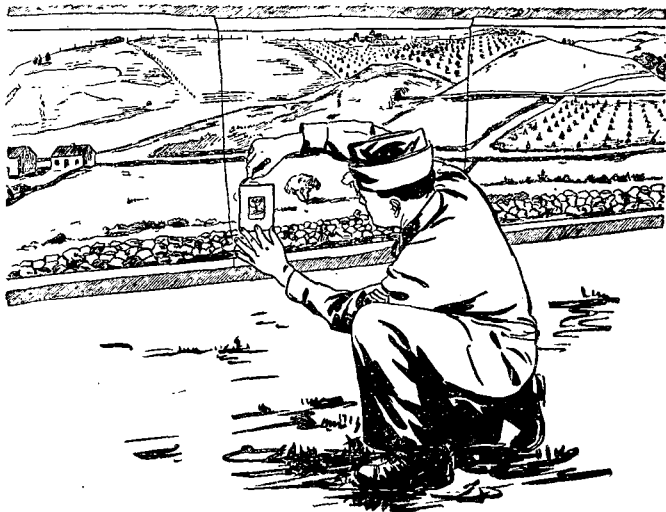

FIGURE 65.—Lining in scoring area (point target) with scoring template.

rectangle is 5 inches high by 4 inches wide. For a distance of 50 feet, the 50-percent zone is a rectangle 1½ inches high by 1.2 inches wide; the 75-percent rectangle is 3 inches high by 2.4 inches wide. The target is at the center of the inner rectangle or 50-percent zone.

(3) For a linear target, such as a small area over which the riflemen will distribute their fire, the 50-percent zone is formed by two lines drawn parallel to the longer axis of the target (area) and with the target midway between those

lines. A suitable scoring device (fig. 66), conforming in size to the 50- and 75-percent shot groups expected of average shots at 1,000 inches and at reduced ranges, can be made for a linear or vertical target as described above for a point target. Also, it is used in a similar manner (fig. 67). For a distance of 1,000 inches, the lines should be $2\frac{1}{2}$ inches apart; for a distance of 50 feet, the lines should be $1\frac{1}{2}$ inches apart. Two additional lines similarly drawn form the 75-percent zone. For a distance of 1,000 inches, the lines should be 5 inches apart; for a distance of 50 feet, the lines should be 3 inches apart. The width of the zones will vary according to the size of the target selected. For a distance of 1,000 inches, the zones extend 1 inch beyond each end of the target; for a distance of 50 feet, the zones extend 0.6 inch beyond each end of the target. The zones are then divided into a convenient number of equal parts, the number depending on the length (width) of the target and the number of men firing. This is done in order to give a score for distribution of shots fired on a linear target (par. 196).

(4) Figure 68 shows a scorer placing the scoring template on a vertical target.

■ 194. ZEROING OF RIFLES.—*a.* It will be necessary to zero the rifles used before firing exercises on the landscape target. A target with two rows of ten 1-inch-square black pasters (Nos. 1 to 10, from right to left, fig. 69) with bottom row about 6 inches from and parallel to the bottom edge of the target, should be prepared and used for zeroing. In all firing for zeroing, sandbag rests are used.

b. The procedure in detail is as follows:

(1) The sights of the rifles are blackened if necessary.

(2) The squad is deployed on the firing point; the squad leader takes the proper position in rear of the squad.

(3) The instructor causes each firer to set his sights at zero elevation and zero windage, or minimum range and zero windage for the automatic rifle, and then checks each sight setting.

(4) Each man is assigned the particular small black paster which corresponds to his position in the squad as his aiming point.

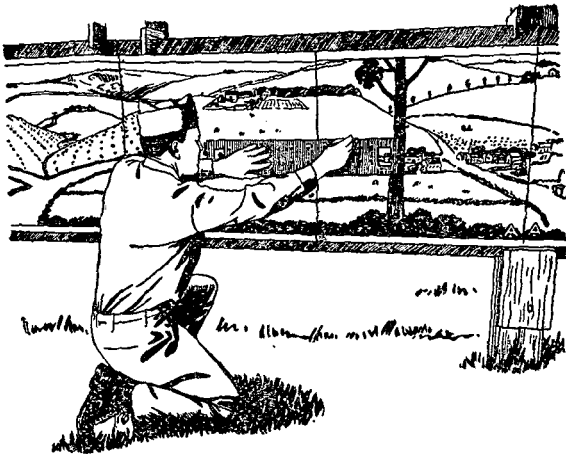

FIGURE 66.—Lining in scoring area (horizontal linear target) with scoring template.

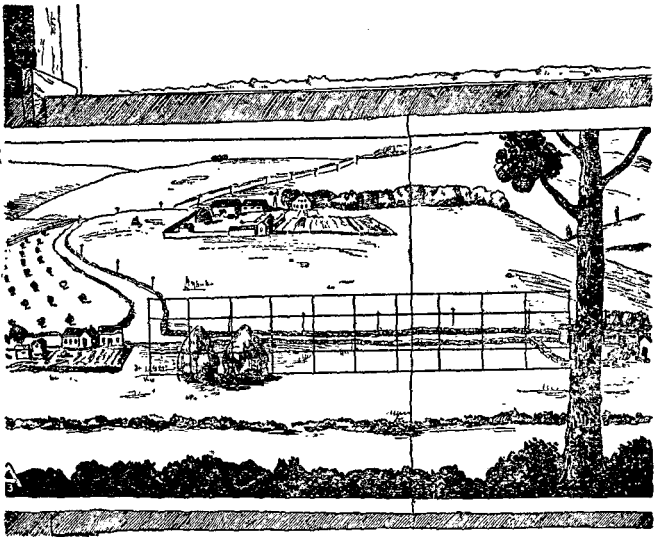

FIGURE 67.—Landscape target panel showing linear target with scoring areas and distribution spaces.

(5) Three rounds are issued to each man on the firing point, to be loaded and fired singly at the command of the instructor, or to be loaded as a partial clip of three rounds.

(6) Each man fires three shots at his paster at the command **THREE ROUNDS, COMMENCE FIRING.**

(7) The instructor commands: **CLEAR RIFLES.** The squad leader checks to see that this is done.

(8) The instructor and squad leader inspect the target and, based upon the location of the center of impact of the re-



FIGURE 68.—Using target scoring template to divide a vertical target into spaces to give score for distribution.

sultant shot group, give each man the necessary correction for his next shot, in terms of clicks.

(9) The firing continues as outlined above until all rifles are zeroed; that is, until each man has hit his aiming point.

c. For the caliber .22 rifle equipped with the Lyman receiver sight—

(1) At a distance of 1,000 inches, a change of 5 minutes in elevation (10 clicks) will move the strike of the bullet about $1\frac{1}{2}$ inches. A change of 1 point of windage (8 clicks) will move the strike about $1\frac{1}{4}$ inches. A simple rule of thumb is

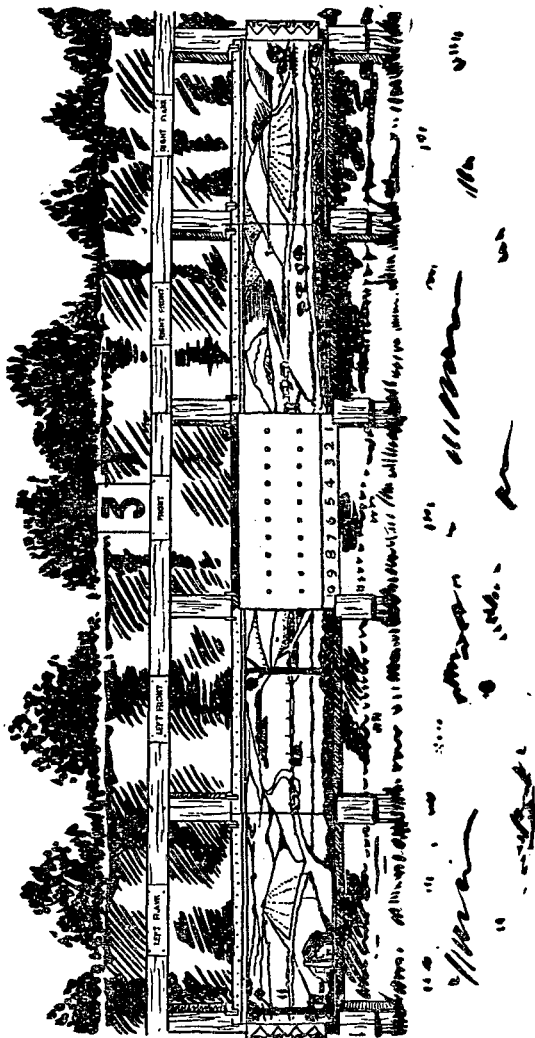

FIGURE 69.—Number bar under zeroing panel.

that 1 click of elevation or windage will move the center of impact of the bullet approximately $\frac{1}{8}$ of an inch.

NOTE.—Actually, 1 click of elevation moves the strike of the bullet $\frac{3}{20}$ of an inch, at 1,000 inches.

(2) At a distance of 50 feet, a change of 6 minutes in elevation will move the strike of the bullet about 1 inch, and a change of 1 point of windage will move the strike about $\frac{3}{4}$ of an inch. For additional details, see TM 9-280.

d. For the caliber .30, M1 rifle—

(1) At a distance of 1,000 inches, changes of one click in elevation and windage, respectively, will move the strike of the bullet about $\frac{1}{4}$ of an inch in the changed direction.

(2) At a distance of 50 feet; a change of one click in elevation and windage, respectively, will move the strike of the bullet about $\frac{1}{6}$ of an inch in the changed direction.

e. For the Browning automatic rifle, caliber .30 M1918A2—

(1) At a distance of 1,000 inches, changes of one click in elevation and windage, respectively, will move the strike of the bullet about 1 inch in the changed direction.

(2) At a distance of 50 feet, a change of one click in elevation and windage, respectively, will move the strike of the bullet about $\frac{1}{2}$ inch in the changed direction.

■ 195. FIRING PROCEDURE.—The sequence of events in conducting firing exercises is as follows:

a. All members of the squad except the squad leader face to the rear. ●

b. The instructor takes the squad leader to the panels and points out the target to him. They return to the firing point and the squad leader then takes charge of the squad and has the men resume their firing positions.

c. The squad leader gives the command LOAD, cautioning, “___ rounds.” If the automatic rifle is being used, it should be given more rounds than the rifles. If caliber .22 rifles are being used by the automatic rifle team, each man of the team is given the same number of rounds as a rifleman. The three members of the team then represent the fire power of the automatic rifle and distribute their fire on linear targets as prescribed for the automatic rifle.

d. The squad leader designates the target orally. Refer-

ence to panels to indicate direction should not be allowed in the designation. To complete the fire order, the squad leader adds: **COMMENCE FIRING.**

e. When the squad has completed firing, the squad leader commands: **CEASE FIRING, CLEAR RIFLES.** The squad then examines the target. The target panel is scored and marked with the squad number.

f. The instructor holds a critique after each exercise.

■ 196. **SCORING.**—*a. Concentrated fire.*—In concentrated fire, the sum of the value of the hits within the 2 zones is the score for the exercise. For convenience of scoring and comparison, 100 is fixed as the maximum score. Any method of scoring and of distribution of ammunition among members of the squad may be used. The following examples, based on firing 50 rounds, are given as suggested methods:

(1) Value of each hit in 50-percent zone, 2.

(2) Value of each hit in 75-percent zone but outside the 50-percent zone, 1.

b. Distributed fire.—A method of scoring for distributed fire of the squad on a target of width is as follows:

(1) Value of each hit in 50-percent zone, 2.

(2) Value of each hit in 75-percent zone but outside the 50-percent zone, 1.

(3) Value of each distribution space which is hit (if target is divided into 10 equal spaces), 10.

(4) The score for distribution (100 possible), plus the value of all hits (100 possible), divided by 2, is the score for the exercise. Again, 100 is fixed as the maximum score.

■ 197. **EXERCISES.**—*a. (1) No. 1.*—(a) *Purpose.*—To teach target designation and to show the effect of concentrated fire.

(b) *Method.*—The squad leader employs the fire of his squad on one point target indicated to him by the instructor.

(2) *No. 2.*—(a) *Purpose.*—To teach target designation and the division of the squad fire on two points of concentration.

(b) *Method.*—The instructor indicates two point targets to the squad leader, giving the nature of each. The squad leader applies the fire of his squad on the two targets in the proportions directed by the instructor. The scoring

will be as for concentrated fire on each target, the several scores being combined in totals for the score of the exercise.

(3) *No. 3.*—(a) *Purpose.*—To teach target designation, fire distribution, and fire control in diverting part of the fire of the squad to a suddenly appearing target.

(b) *Method.*—The instructor indicates a target of width (linear target) to the squad leader. After firing has commenced, the instructor indicates and gives the nature of a new (point) target to a flank. After this second target is indicated and he is directed by the instructor, the squad leader shifts the fire of the automatic rifle (group of 3 or more caliber .22 rifles) to the new point target. A simple method of scoring this type of exercise is to add the value of hits on the point target, the value of hits on the target of width, and the score for distribution on the target of width, and divide this sum by 2. This provides a score for the problem on a basis of a possible of 100 points.

(4) *No. 4.*—(a) *Purpose.*—To teach the application of fire on an enemy group marching in formation, the fire control necessary to obtain fire for surprise effect, and to show the effect of fire on troops in formation.

(b) *Method.*—The instructor indicates to the squad leader a target that represents a small group of the enemy marching in approach march, patrol, or other formation. It is assumed that the enemy is not aware of the presence of the squad. The squad leader applies the fire of his squad; his instructions must result in the simultaneous opening of fire of all weapons and the distribution of fire over the entire target. The assignment of half the riflemen to fire at the rear half of the target and the remaining riflemen to fire at the forward half, with the automatic rifleman covering the entire target, is a satisfactory method of distributing fire over such a target (par. 179).

b. The assistant squad leader will be given instruction and practice in the same type of exercises as outlined in *a* above.

c. Caliber .30 as well as caliber .22 ammunition may be used to provide training for the automatic rifleman.

(1) *Using caliber .30 ammunition.*—When caliber .30 ammunition is available it is desirable to fire the automatic rifle on landscape targets so as to provide training for the automatic rifle team.

(2) *Using caliber .22 ammunition.*—When caliber .30 ammunition is not available but caliber .22 ammunition is to be had, the fire effect of the automatic rifle team may be simulated with the squad by grouping the automatic rifle team together when engaging targets.

SECTION VII

FIELD TARGET FIRING

■ 198. **SCOPE OF TRAINING.**—The training in this phase is similar to that given the soldier in landscape target firing but with the added features of the use of cover and concealment, range estimation, firing the caliber M1 rifle and the automatic rifle with ball, armor-piercing, and tracer ammunition at field targets, at unknown ranges, and fire control under more difficult conditions. Training must be progressive, the soldier first being given an opportunity to fire at more or less exposed targets, followed by fire at targets which are concealed from view but exposed to fire. Individuals should preferably receive this training in the squad or in smaller groups.

■ 199. **TERRAIN, TARGETS, AND RANGES.**—*a. Terrain.*—(1) The availability of ground and considerations for safety determine the selection of terrain for field firing ranges. Where possible, varied ground suitable for the employment of the weapons of the squad will be selected. It is a great advantage from the instructional standpoint to use ground that is unfamiliar to the unit to be trained.

(2) In the absence of other facilities, the known distance ranges can be used by arranging the exercises so that they will begin off the range and require the delivery of fire on the range and in a safe direction.

b. Targets.—(1) Targets may be improvised from available material or they may be obtained from the Ordnance Department.

(2) With the field targets furnished by the Ordnance Department, a stationary target may be represented by E or F targets placed on stakes and driven in the ground or set in sockets (fig. 85).

(3) A surprise target that can appear and disappear may be made by using either E or F targets or dummies, fastened to an I-beam, rope, or pole, and operated by a man in a pit (figs. 70 to 84).

(4) A movable field target may be made by fastening E or F targets to a sled (fig. 29), or by suspending such targets from a wire (figs. 75 and 77).

(5) In the field, targets should be placed in locations that would be used by intelligent enemy. They should not be prominently exposed nor in a regular line. Targets used should vary in size and the degree of concealment (at ranges unknown to the firer) in which they are placed. The exposure of targets kept out of sight at the beginning of an exercise may be indicated by the firing of blank ammunition or the operation of other noise or smoke-producing equipment in the vicinity of the target when it does appear (fig. 86). To test the proficiency and skill of the squad leader in designating the target and adjusting fire, targets may be so placed as to be visible with the binocular but entirely invisible to the naked eye.

(6) The appearance of the targets from the firing line will depend a great deal upon the direction of the sun, the background of the targets, and the angle at which the targets are placed. These factors should be taken into consideration when placing the targets for any particular exercise.

c. Ranges—shelter.—(1) Ranges for field firing exercises can be efficiently operated without an elaborate system of shelters and dugouts. Simple pits to accommodate the target operators are sufficient.

(2) Every effort should be made to avoid altering the natural appearance of the terrain when locating and camouflaging targets and when locating and constructing pits (figs. 70, 74, 77, and 83).

(3) When targets are placed in the rear or to one side of the pits, the likelihood of ricochets falling into the pits is minimized (figs. 73, 79, and 80). If tracer ammunition is to be used, it is best to have covered pits. (See fig. 70 (view from firing line) and figs. 77 and 83 (rear view).) It is desirable to have all pits and the firing line connected by telephone. Small portable two-way voice radio sets may be used if available.

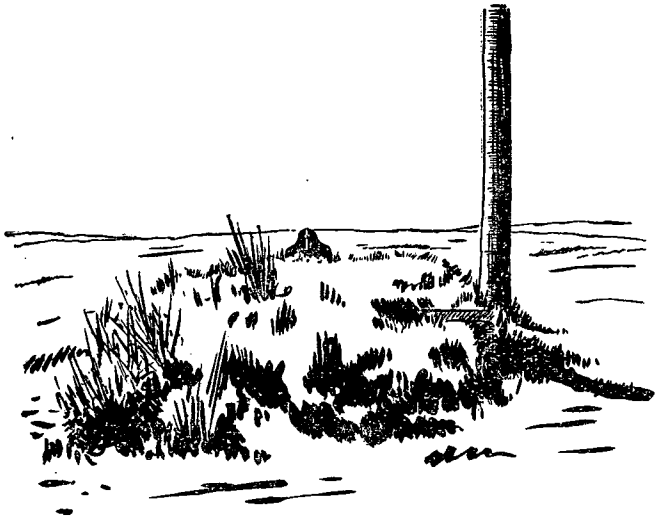

FIGURE 70.—Surprise target at pit. (See figs. 82 and 83 for operating details.)

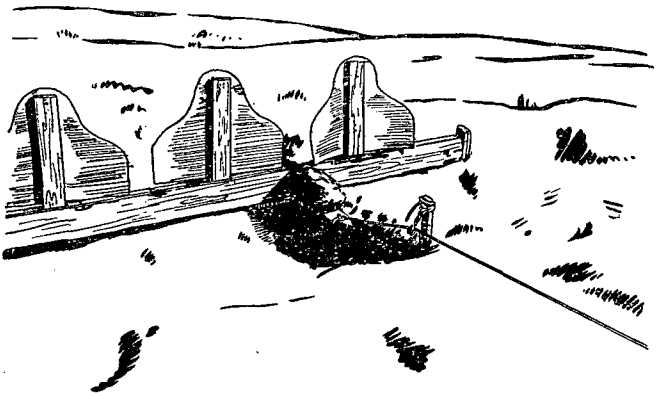

FIGURE 71.—Method of raising surprise point targets. (Note pull rope and counterweight in rear.)



FIGURE 72.—Arrangements for raising surprise targets and producing fire to attract attention. (Cardbord shield protects light machine gun from dirt and dust.)

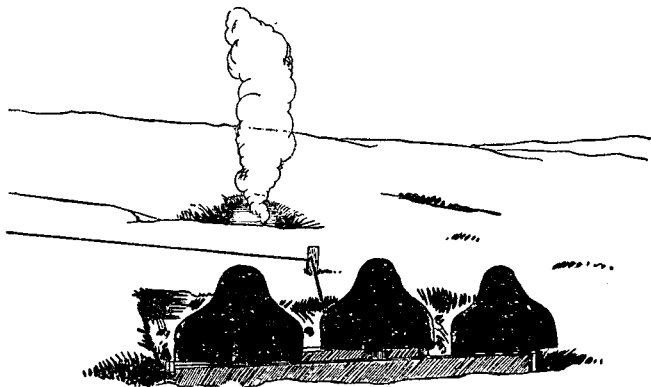

FIGURE 73.—Arrangement for showing surprise (point) target and creating machine-gun fire for sound effect. (Dust is raised by light machine gun rounds striking into earth.)



FIGURE 74.—Method of breaking outlines of silhouette targets.

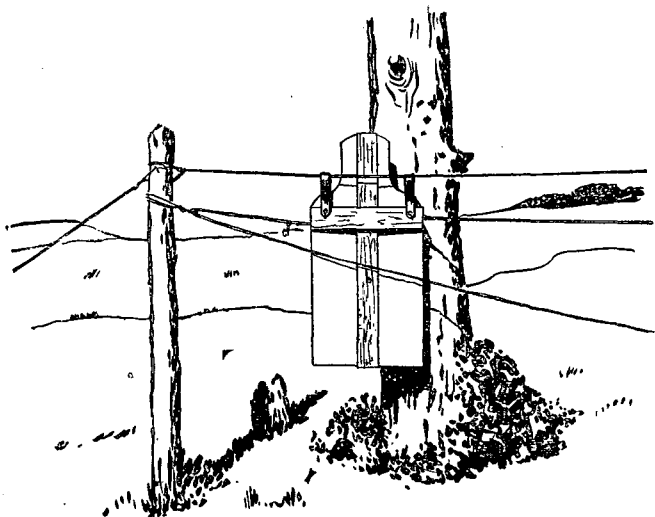

FIGURE 75.—Arrangement for moving surprise target along horizontal line (running figure).

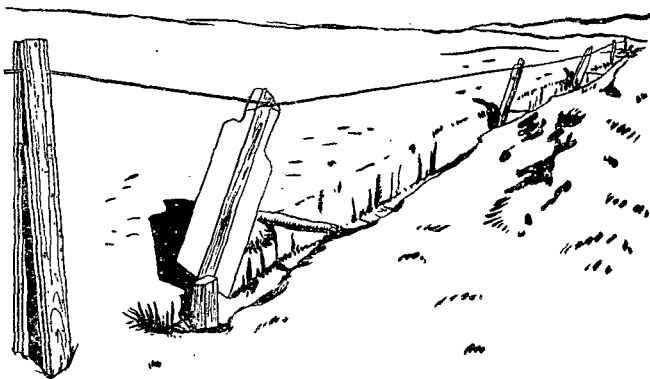

FIGURE 76.—A method of raising surprise targets (linear target).

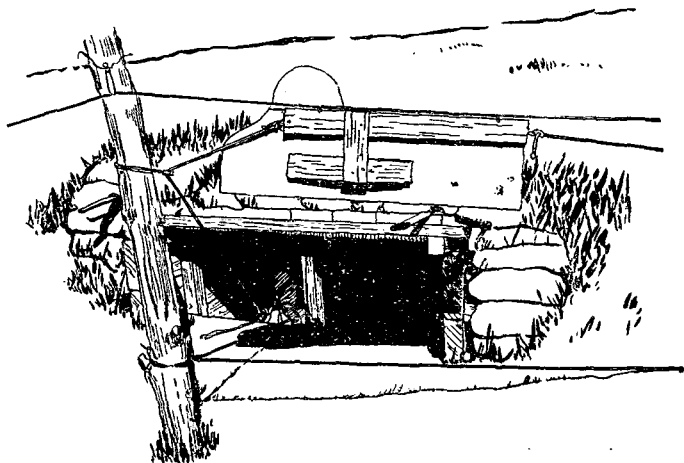

FIGURE 77.—Method of exposing surprise target moving horizontally along the ground (crawling man).

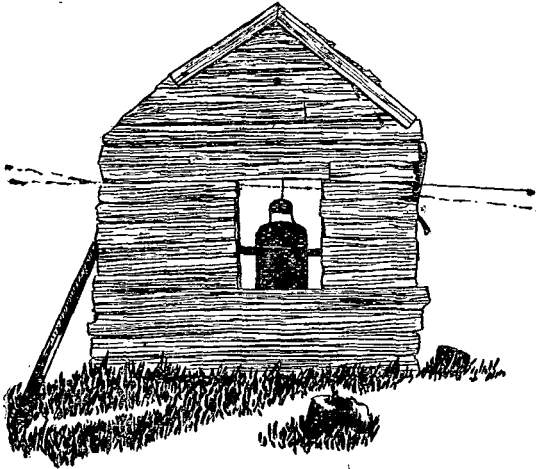

FIGURE 78.—Surprise target appearing in window.

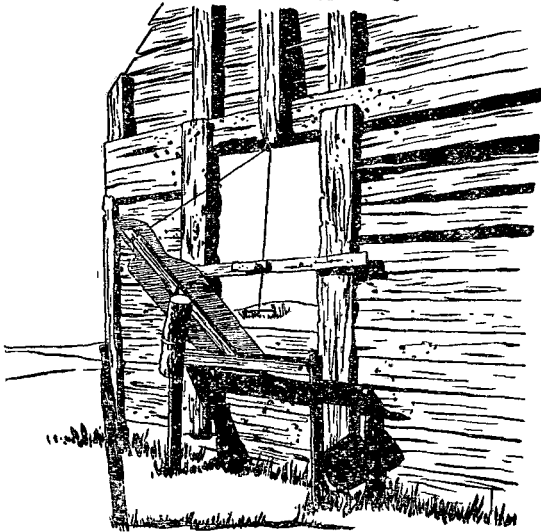

FIGURE 79.—Arrangement for raising surprise target in window from pit.

■ 200. GENERAL CONSIDERATIONS.—*a. Progressive training.*—Although field target firing does not involve the tactical application of fire and movement, training in moving from an approach march formation or a place of concealment to firing positions is included primarily for the following two purposes:

(1) To teach the soldier the proper use of cover and concealment and the intelligent selection of firing positions.

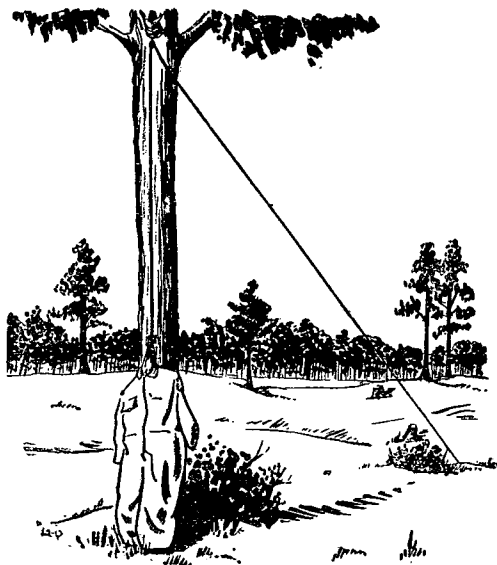

FIGURE 80.—Method of raising surprise target in tree (sniper).

(2) To combine the technique of applying and controlling collective fire with scouting and patrolling and other related subjects.

b. Firing positions and representation of enemy.—In battle, a unit is not deployed with individuals abreast and at regular intervals apart. The selection of individual and group positions is governed by the field of fire, cover or concealment while firing, covered route(s) of approach to those positions,

fire control, and nature of target. The representation of the enemy will conform to irregular battle formations.

c. *Use of cover.*—(1) The proper use of available cover is important because—

(a) The man who neglects the use of cover will be seen and hit.

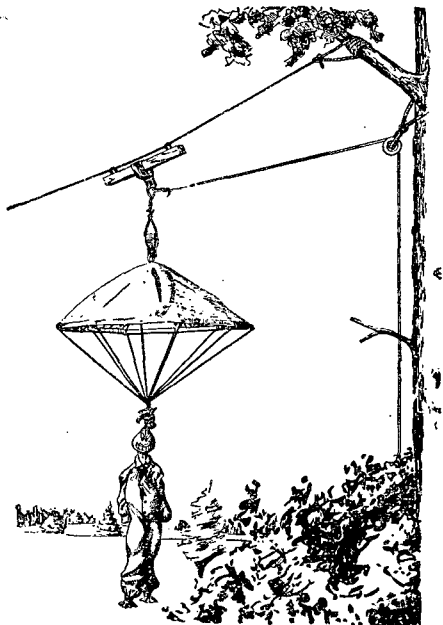

FIGURE 81.—Arrangement for raising and lowering surprise target (parachutes). (Control rope leads to pit.)

(b) His squad not only loses the fire effect of one rifle or automatic rifle, but its position is unnecessarily disclosed and other casualties may follow.

(2) The individual use of cover and concealment is taught in FM 21-45. For training in firing at field targets, the principles are the same.

(3) In seeking covered and concealed firing positions, men must avoid those places which mask the fire of others or

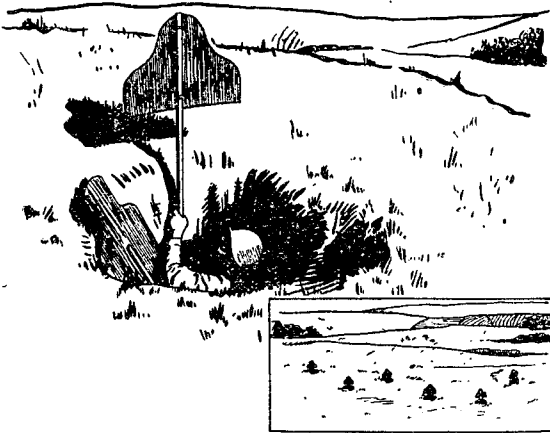

FIGURE 82.—Method of displaying surprise target to represent skirmishers.

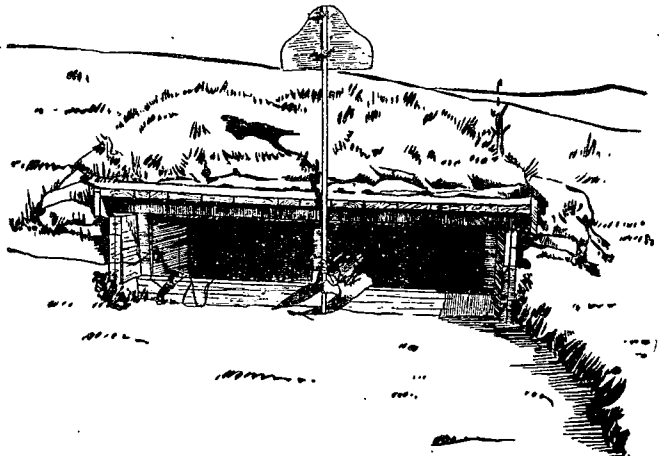

FIGURE 83.—Method of exposing surprise target. (See fig. 70 for front view.)

cause their fire to be dangerous to other men of their unit. Also, if there is the probability of hostile detection while moving into a firing position, men should understand that a few yards movement in any direction, if it can be made by a covered or concealed path, will permit fire from an undisclosed position. Bunching must be avoided. In selecting a covered position, however, the field of fire should receive first consideration. No attempt should be made to secure

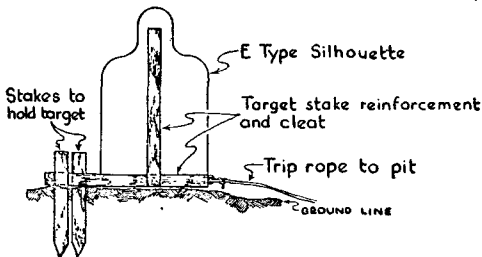

FIGURE 84.—One method of withdrawing a stationary field target.

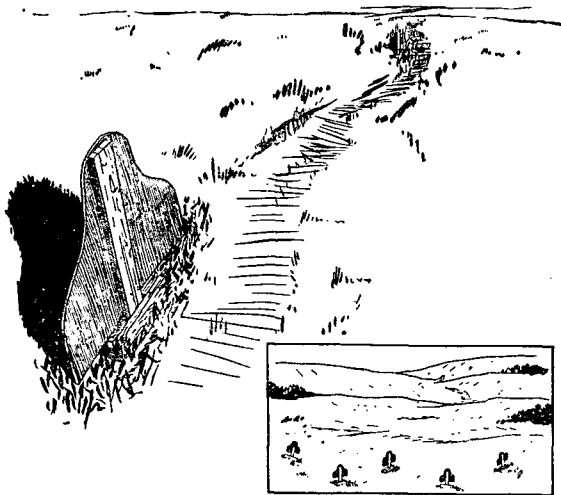

FIGURE 85.—Method of setting up targets to represent skirmishes.

cover in a deflated position which necessitates firing while sitting, kneeling, or standing. Usually a position nearer the crest to the front can be found which will permit firing in the prone position and which will give a better field of fire.

d. Marksmanship applied.—(1) The principles of rifle and automatic rifle marksmanship are followed in this training so far as they suit existing conditions.

(2) These principles should be applied to the technique of fire and to combat in a common sense way. It should be

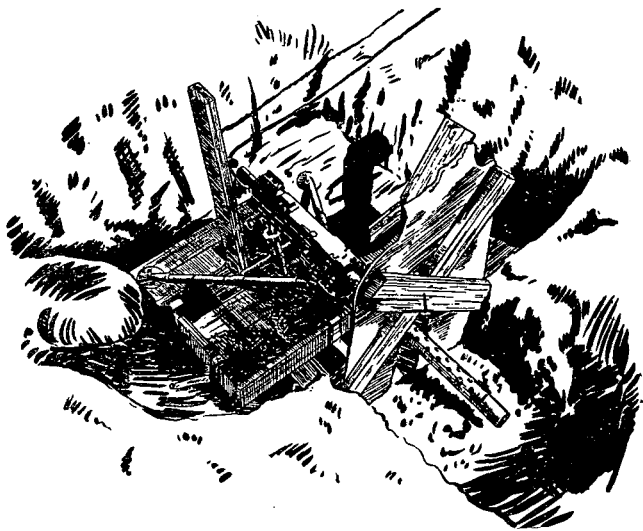

FIGURE 86.—Details showing method of installing light machine gun to produce sound effect.

appreciated that the conditions encountered in combat situations will differ from those found on the target range. On the target range the soldier is expressly prohibited from resting his rifle against an unauthorized rest while firing. In firing at a field target and in battle, the soldier takes advantage of trees, rocks, or any other rest which will make his fire more accurate. The positions prescribed in marksmanship are used whenever the ground will permit, but on rough

ground it is often necessary to modify them in order to get a comfortable and steady position. In aiming at a target in combat, the sights should be alined on that point of the target that it is desired to hit; this differs from the method of aiming on the target range.

e. Use of battle sight.—The battle sight corresponds to a sight setting of 300 yards. It is used on targets from 0 to 400 yards when time is lacking for setting the sight or in firing at moving targets.

f. Firing at field targets.—Squad members should receive practice in firing at field targets before firing squad problems. The preliminary practice in firing at field targets should be at ranges of 400 yards or less. Provisions for preliminary field target firing may be made on any field target firing range. The scope and the method of conducting this training are outlined in paragraph 238.

■ 201. EXERCISE.—*a. General.*—(1) Exercises for firing at field targets should be suitable to the actual terrain upon which they are conducted. Some of these exercises will be fired with the gas mask adjusted, and should be repeated until all men have demonstrated their proficiency in firing the rifle and automatic rifle with the gas mask adjusted.

(2) Each exercise should be initiated by a unit either—

(a) Already deployed in a firing position.

(b) Halted in approach march formation or in a place of concealment with scouts present in formation, the unit either acting along or as part of a larger force.

(c) Advancing in approach march formation with scouts out.

(3) (a) In the first case, all men should be in selected firing positions, special attention being paid to individual cover and concealment.

(b) In the second case, when practicable, squad leaders conduct their squads forward by covered and concealed routes and send the riflemen and the automatic riflemen to their firing positions by individual directions. Occupation of the initial firing position of a unit is done with the minimum of exposure.

(c) In the third case, the advance of the scouts must be checked by either represented or assumed enemy fire when

they are in the vicinity of a suitable location for a firing position for the squad; otherwise, to insure their safety, the scouts may have to be withdrawn from the exercise before firing is begun by the squad.

b. Critique.—Upon completion of any firing exercise, when the range is clear, the targets are scored, after which the instructor conducts a critique of that exercise. A suggested list of items to be covered during such a critique is shown in the outline below. Only those items are discussed which are specifically applicable to the exercise being critiqued.

FIELD TARGET FIRING CRITIQUE

- I. *Purpose of problem.*
- II. *Orders of squad leader.*
 - a. Method of target designation. (Was it appropriate?)
 1. Accuracy of range, direction, and description.
 2. Brevity—clearness.
 3. Use of concealment during designation.
 - b. Method of completing fire order (appropriate).
- III. *Approach and occupation of the firing position.*
 - a. Method.
 - b. Time taken (if time is a factor).
 - c. Distribution on firing point.
- IV. *Actions of individuals.*
 - a. Use of cover and concealment.
 - b. Attention to orders.
 - c. Looking to leader for signals.
 - d. Individual initiative.
- V. *Rate of fire.*
 - a. Initially rapid to pin enemy to ground.
 - b. Controlled to conserve ammunition with maximum effect.
- VI. *Fire control.*
 - a. Position.
 1. Initial position of leader.
 2. Initial position of second in command.
 3. Movement of leaders during firing.

b. Methods used.

1. Signals.
2. Verbal orders.
3. Use of assistant squad leader.
4. Time required to shift fire to new targets.
5. Distribution of fire.
6. Adjustment of fire.
7. Teamwork developed.

VII. Effect of fire.

- a. Were all targets fired on?
- b. Were all targets hit?
- c. Score.

c. *Exercises.*—(1) *No. 1.*—(a) *Purpose.*—Practice in fire orders, application of the fire of a squad in position, fire control, and proper individual concealment in the occupation of the firing position.

(b) *Method.*—Enemy represented by one group of targets exposed to fire but partially concealed from view; requiring a simple fire order. Squad leader is shown the targets (personnel with flag) and safety limits for firing position of the squad. When the squad leader fully understands the location and nature of the target and the instructor informs him that the range is clear, he will load ball ammunition, give the fire order, and fire the problem. The range should be estimated by eye, and the target should be designated by oral description.

(2) *No. 2.*—(a) *Purpose.*—Practice in correct issuance of fire orders, application of the fire of a rifle squad on a linear target, fire control, proper deployment and individual concealment in the occupation of the firing position, and engagement of a surprise target.

(b) *Method.*—Silhouette targets representing an enemy squad deployed in a firing position are partially concealed from view but exposed to fire. Squad is in rear of the firing position; squad leader is shown the linear target (by flag) and then conducts squad forward and disposes it in a concealed firing position. When squad leader is told the range is clear, he will engage the target with fire. A surprise target, well to the flank of the first target and representing an enemy machine gun, appears shortly after the squad has

engaged the linear target. The squad leader is told the amount of fire to shift to the surprise target.

(3) *No. 3.—(a) Purpose.*—To show the fire action of scouts when fired on, including the designation of a target by the scouts using tracer bullets, and to give the squad practice in approaching and occupying firing positions.

(b) *Method.*—The squad is marching in approach march formation with both scouts well in advance. When the scouts reach the firing position they are told that they are under fire from any enemy group represented by targets about 400 yards to their front. They determine the range by firing on the target with tracer bullets. The squad leader conducts his squad forward, establishes the men in firing positions, and engages the targets with the proper class of fire after the targets have been designated by the scouts by the use of tracers. Special attention is paid to the use of cover and concealment by all men while moving up and during the selection and occupation of positions.

(4) *Additional exercises.*—Suggested subject matter for additional problems is listed below:

(a) A situation to show the fire action of the squad when the scouts observe an enemy group without the enemy having detected their presence.

(b) A situation which requires the leader to use his automatic rifle, while keeping his riflemen, initially, under cover.

(c) A situation which requires the initial use of either a part or all of the riflemen, and then, later in the exercise, a surprise target appearing which requires the use of the automatic rifle team on the surprise target.

(d) A situation requiring the automatic rifleman to deliver fixed fire under conditions of low visibility; for example, the firing of grazing fire along a final protective line (see par. 239).

(e) A situation requiring the automatic riflemen to fire from position defilade. This method is described in paragraph 240. Suggested situations are:

1. In defense of a road block.
2. In defense of a stream crossing.
3. In delaying action.

4. In providing support for an adjacent unit without committing the automatic rifle team to such an extent that it cannot be withdrawn for other use.
5. Delivering fire over the heads of forward defiladed elements.

(f) A situation requiring the cooperation of the automatic rifle team and the rifle grenadier. Examples of such situations are:

1. A group of enemy in a depression, such as a quarry or cellar, is driven into the open by the rifle grenadier using antipersonnel grenades. The automatic rifle, which has been placed in position to enfilade the avenues of escape, covers a "killing zone," assuring destruction of the enemy when he is forced into the open.
2. While the automatic rifle engages an enemy tank to prevent the crew from opening doors to throw grenades into fox holes and emplacements, the rifle grenadier knocks out the tank when it comes within range.
3. The use of the automatic rifle to prevent the escape of the crew from a disabled hostile tank, or to prevent enemy salvage crews from rendering assistance to the disabled tank, after it has been disabled by the rifle grenadier.

(g) A situation to show the use of the automatic rifle team in street fighting. Suitable uses are:

1. To establish "killing zones" in streets and alleys.
2. To fire on doors and windows to cover the approach of the riflemen of the squad.
3. To cover a street barricade with fire.

(h) A situation requiring the use of the automatic rifle in wooded areas. Examples are:

1. To spray brushy areas where enemy are known to be concealed.
2. To cover lanes, gaps, or small open spaces.

(i) A situation requiring the use of the automatic rifle to deceive the enemy as to our own strength. Examples are:

1. Use of single shots to hide the fact that it is an automatic weapon.

2. Use of rapid single shots to make the strength in riflemen appear greater than it actually is.
- (j) A situation requiring the use of the automatic rifle team against aerial targets. Examples are:
1. Low-flying enemy planes (radio-controlled planes may be used, if available).
 2. Enemy paratroopers.
- (k) A situation requiring the use of large bursts of fire with the automatic rifle. Examples are:
1. Against assaulting troops.
 2. Against a hostile machine gun at a short range (100 yards).
 3. Against a large enemy column.
 4. Against compact, well-concealed groups.
- (5) *Related training.*—Depending upon the availability of time, range facilities, and sufficient quantities of ammunition, field target firing exercises should be extended to include tactical situations requiring actions and orders of platoon, squad, and assistant squad leaders. This type of training is referred to as “combat training exercises.” Frequently, these exercises are conducted over extended periods of time and often should include the wearing of gas masks until all men have demonstrated their proficiency in firing the rifle, advancing, and engaging in hand-to-hand combat without appreciable physical discomfort. At the end of this training period, higher commanders conduct their tests to determine the proficiency of rifle platoons. These tests are called “platoon combat proficiency tests.”

SECTION VIII

DESTRUCTION OF ORDNANCE MATÉRIEL IN EVENT OF IMMINENT CAPTURE IN COMBAT ZONE

■ 202. **GENERAL PRINCIPLES.**—The decision to destroy ordnance matériel to prevent its capture and use by the enemy is a command decision and will be ordered and carried out only on authority delegated by the division or higher commander.

a. Principles governing destruction.—The following are the fundamental principles to be observed in the execution of an order to destroy small arms:

(1) The destruction must be as complete as the circumstances will permit.

(2) Lacking time for complete destruction, the parts essential to operation of the weapon must be destroyed, beginning with those parts most difficult for duplication by the enemy.

(3) *The same essential parts of each weapon must be destroyed to prevent the reconstruction of a complete weapon from several damaged ones.*

b. Training.—The training of individuals before they reach the combat zone will be such as to insure their ability to destroy quickly and adequately the weapon(s) with which they are armed in an established and uniform sequence based on the principles stated in *a* above. *Training* will not involve the actual destruction of matériel.

c. Methods.—Of the two methods outlined herein for the destruction of the automatic rifle, the first is preferred.

(1) *Method No. 1.*—Remove the bolt and slide. Grasp the butt with both hands and smash the barrel against a tree, rock, or firm ground until it is bent. Remove and distort the recoil spring. Remove the firing pin, insert its point into the hole in the face of the bolt, and break it off. Break the slide by inserting the piston end into the front end of the receiver and pulling up on the other end of the slide. Elapsed time required for this method: 1 minute.

(2) *Method No. 2.*—Insert the bullet end of a complete round into the slot in either side of the bipod body and bend the case slightly, distending the mouth of the case to permit pulling out the bullet. Retain sufficient powder to cover the bottom of the case to a depth of approximately $\frac{1}{8}$ inch, and spill the remainder. Reinsert the bullet in the case, *point first*. Chamber and fire this round with the reduced charge; the bullet will stick in the bore. Chamber one complete round, lay the rifle on the ground, and fire it, using a 30-foot lanyard. Use the best available cover, as this means of destruction may be dangerous to the person destroying the

weapon. Elapsed time required for this method: 2 or 3 minutes.

(3) *Warning.*—Do not attempt to destroy the automatic rifle by firing it with the muzzle stuck in the ground. Destruction by this means is not assured.

d. Destruction of ammunition.—When time and materials are available, ammunition may be destroyed as follows: Break out all packed ammunition from boxes or cartons. Stack the ammunition in a heap. Stack or pile wood, or available gasoline and oil in cans or drums, around the ammunition. Throw onto the pile all available inflammable material such as scrap wood and brush. Pour any remaining gasoline or oil over the pile. Sufficient inflammable material must be used to insure a very hot fire. Ignite the materials and take cover. Thirty to sixty minutes will be required to destroy the ammunition carried by small combat units.

CHAPTER 6

ADVICE TO INSTRUCTORS

	Paragraphs
SECTION I. Mechanical training.....	203-211
II. Marksmanship, known distance targets.....	212-225
III. Marksmanship, aerial targets.....	226-230
IV. Technique of fire.....	231-240

NOTE.—The provisions of this chapter are to be accepted as a guide and will not be considered as having the force of regulations. They are particularly applicable to emergency conditions when large bodies of troops are being trained under officers and non-commissioned officers who are not thoroughly familiar with approved training methods.

SECTION I

MECHANICAL TRAINING

■ 203. GENERAL.—Mechanical training lends itself readily to the use of the applicatory system of instruction. The automatic rifle teams of the entire battalion, company, or platoon, each with its set of equipment and under the direct supervision of a trained assistant instructor, are assembled in a suitable area or building. The unit instructor supervises the instruction of the teams. Explanation and demonstration are concurrent, each assistant instructor demonstrating the elements of the phase of instruction as the unit instructor explains it. For short periods of practical work the instruction is decentralized under the assistant instructors.

■ 204. DISASSEMBLY AND ASSEMBLY OF AUTOMATIC RIFLE.—*a. Equipment necessary for each automatic rifle team.*

1 Automatic rifle.

1 magazine.

1 shelter-half or blanket (to keep parts out of dirt) or table if training is conducted indoors.

1 dummy cartridge.

b. Procedure.—(1) Have assistant instructors disassemble and assemble the rifles, step by step, while the unit instructor is explaining the procedure. It is helpful to the instructor to have an assistant beside him performing the operations described.

(2) Turn the rifles over to the students for practical work.

(3) Ask questions.

■ 205. DISASSEMBLY AND ASSEMBLY OF GROUPS.—*a. Equipment.* Same as in paragraph 204*a.* Extra rifles, magazines, and one spare combination buffer and rate-reducing mechanism are desirable, if available.

b. Procedure.—(1) The instructor has one assistant instructor with him. This man performs every step of disassembly and assembly as directed by the instructor, thereby serving as a time-gage for the speed of instruction and explanation. Also, this assistant instructor, as well as the assistant instructor with each team, points out each part on the automatic rifle as the instructor names the part.

(2) When the instructor starts his disassembly lecture, the assistant instructors will remove each part from the rifle when and in the exact manner as the instructor prescribes. As soon as the operating group (fig. 2) has been disassembled and laid out in order from left to right, the instructor calls on members of the various teams to name certain parts in the order of their disassembly. As the parts are named, the instructor repeats the name of each part to make sure that everyone knows the correct name. When the instructor feels that every man knows the names of the 16 operating parts, he has the assistant instructors correctly assemble the parts. He should make sure that the assistant instructors work in unison, replacing each part as directed. Practical work follows, with each team member disassembling and assembling the operating parts under the watchful supervision of an assistant instructor.

(3) The removal of the firing pin and extractor, without disassembling the rifle, is performed by the assistant instructors under the direction of the instructor. This is followed by practical work in this operation by the team members.

(4) The disassembly and assembly of the trigger group, bipod group, and magazine are carried on in the same manner as the operating group. Some instructors prefer to give the function of each group following the practical work on disassembly and assembly of that specific group.

(5) During the practical work, distribute the extra rifles, if any, among the men so that the three team members can work simultaneously. If this is not possible, after one individual has completed the disassembly and assembly of a group, he should pass the rifle on to the next man. (The combination buffer and rate reducing mechanism should be fastened to a board and circulated among the teams so that they will be able to see the various parts of this mechanism.)

(6) Ask questions.

■ 206. CARE AND CLEANING.—*a. Equipment.*—Same as in paragraph 204*a*, plus additional equipment necessary for special demonstrations (fig. 15).

b. Procedure.—(1) Explain and demonstrate the cleaning of the rifle, including the gas system, operating parts, sling, and magazine.

(2) Turn the rifle over to the students for practical work.

(3) Ask questions.

c. An explanation and demonstration of the points to be observed before, during, and after firing will prove valuable.

■ 207. FUNCTIONING.—*a. Equipment.*—Same as in paragraph 204*a*, plus a piece of cardboard, measuring approximately 2 by 4 inches, with which to make set-ups (fig. 87). In lieu of the piece of cardboard, a wooden frame can be constructed to represent the receiver of the automatic rifle (fig. 88). A "cutaway" rifle or wooden working models (figs. 8, 11, and 12) of operating parts of the automatic rifle will greatly facilitate instruction.

b. It is necessary that the automatic rifleman have a practical working knowledge of the functioning of the rifle if he is to exact its best performance. Some knowledge of functioning is essential in the application of immediate action. Men should be encouraged to visualize the function in question, for example: "Explain the functioning of all the parts involved in releasing the slide when the trigger is pressed," or "The firing pin has just struck a cartridge—explain what parts were directly concerned in causing the firing pin to strike the primer of the cartridge." Other similar questions may be asked.

c. A method of dividing functioning into operation of groups and demonstrating this operation.—(1) *General.*—The functioning of the Browning automatic rifle should be taken up in a logical sequence of the functioning of the respective parts. The various parts should be assembled on a table or other flat surface. With these parts laid out in the same relative position that they occupy in the rifle, the complete operational cycle can be carefully demonstrated and explained. Assume that the slide is to the rear and caught by the sear; take up the functioning of the parts in the following sequence:

(a) Trigger action.

(b) Forward movement of the slide.

(c) Rearward movement of slide.

(d) Functioning of rate-reducing mechanism and buffer.

(2) *Trigger action.*—(a) *Set-up.*—Trigger group, completely assembled, removed from rifle. Slide removed from rifle and held so the sear notch is engaged by the sear.

(b) *Demonstration on trigger group.*—Observe the sear nose on the sear being depressed as the forward end of the sear is raised by the connector, which rises when the trigger is pressed toward the rear, thus releasing the slide.

(c) *Explanation.*—Since the trigger is fastened at its forward end by the trigger pin, the rear end is raised by pressing toward the rear. The connector is raised by the rear end of the trigger and strikes the forward end of the sear raising it. Since the sear is pivoted at its center, the rear end is lowered as its forward end is raised, thus releasing the slide.

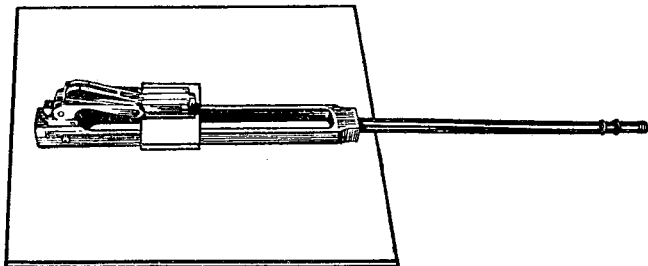

FIGURE 87.—Use of set-up board.

(d) The above demonstration may be made using the wooden frame (fig. 88) in lieu of the cardboard set-up.

(3) *Forward movement of slide.*—(a) *Set-up on rifle.*—Rifle completely assembled.

(b) *Demonstration on rifle.*—Pull the operating handle to the rear, cocking the rifle, press the trigger, and allow the slide to slam forward.

(c) *Explanation.*—The energy which was stored in the recoil spring by compressing it is used to push the slide forward when it is released by the sear.

(d) *Set-up on table* (fig. 87).—Slide, hammer, bolt assembly, and bolt link assembled and placed on the table or

other flat surface as they would be in the rifle. The 2- by 4-inch cardboard is placed on the slide to hold up the bolt. A magazine with one or two dummy cartridges loaded in it is used to demonstrate feeding.

(e) *Demonstration on table.*

1. Pick up the entire cardboard set-up (fig. 87). Hold the magazine so that the top fits between the sides of the slide with the feed rib on the bolt engaging the top cartridge. Push the set-up along the magazine, picking up a cartridge and carrying it out of the magazine.
2. Place the slide on the table, the bolt resting on the piece of cardboard, a dummy cartridge gripped by the extractor. Hold the cartridge from moving forward and pull on the slide until the bolt lock rises and the hammer strikes the firing pin.
3. Demonstrate 2 above several times, having the center rib of the hammer strike the firing pin a sharp blow.

(f) *Explanation.*—As the slide goes forward under the force of the expanding recoil spring, it pushes the bolt forward. The magazine spring holds the cartridge up so that it is picked up by the rib under the bolt. The cartridge is carried forward into the chamber where it is stopped. As soon as the forward movement of the bolt is checked, the bolt link revolves upward (over rear shoulders of the bolt supports) and forces the bolt lock into the locking recess in the receiver. The hammer then continues a short distance forward, striking the rear of the firing pin a sharp blow. The firing pin ignites the cartridge.

(g) The above demonstrations may be made using the wooden frame (fig. 88) in lieu of the cardboard set-up.

(4) *Action of gas.*—(a) *Set-up on rifle.*—Rifle completely assembled, bolt forward and dummy round in the chamber.

(b) *Demonstration on rifle.*—Pull the operating handle smartly to the rear, cocking the rifle. Do this several times.

(c) *Explanation.*—When a cartridge is fired, the expanding powder gases drive the bullet forward. As soon as the bullet passes the gas port, a portion of the gas escapes through the port and strikes the head of the piston, driving it to the rear. This movement of the slide to the rear corresponds

to the movement demonstrated by pulling the operating handle smartly to the rear.

(5) *Rearward movement of slide.*—(a) *Set-up on rifle.*—Rifle assembled, less gas cylinder tube and forearm and trigger group.

(b) *Demonstration on rifle.*

1. Place rifle down, resting on shoulders of rear sight and front sight cover. Grasp the slide at the guide rings and push it slowly to the rear, having the students observe in the opening in the bottom of the receiver (trigger guard opening).
2. Place rifle on left side and insert trigger group in rifle and a dummy cartridge in the chamber, bolt forward. Push slide slowly to the rear, having the students observe in the ejection opening.

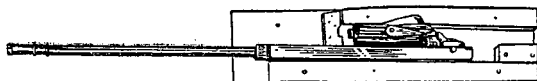

① Set-up to demonstrate action of operating parts.

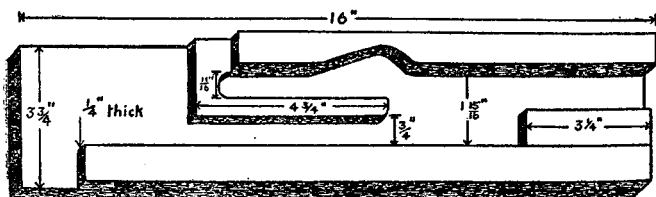

② Wooden frame to represent the receiver.

FIGURE 88.—Action of operating parts.

(c) *Explanation.*—There is a slight movement of the slide to the rear before unlocking begins. This allows the bullet to clear the muzzle, thus insuring against a blow-back of the expanding gases. The link is then rotated downward, withdrawing the bolt lock from the locking recess and camming the firing pin back from the fired cartridge. The recoil spring is compressed. The empty cartridge, gripped by the extractor, is withdrawn from the chamber, slowly at first, and gaining momentum when the bolt lock comes out of the locking recess and then moves rearward with the speed of the slide. The slide continues to the rear and the cartridge is ejected from the rifle by striking the ejector on the

trigger guard. The rearward movement of the slide is slowed down, as the recoil spring is compressed and by striking the rate-reducing mechanism. It is finally stopped without shock by the shock-absorbing mechanism (buffer). The slide starts forward under the action of the recoil spring and is caught by the sear nose engaging the sear notch on the under side of the slide.

(d) The above demonstration may be made using the wooden frame (fig. 88).

(6) *Functioning of rate-reducing and buffer mechanism.*—

(a) *Set-up on rifle.*—Rifle disassembled with slide replaced without recoil spring and guide.

(b) *Demonstration on rifle.*—Push slide to the rear slowly and have students observe in trigger guard opening noting that the rate-reducing mechanism is struck first and driven back, then the buffer is struck, stopping the slide. Pull the slide forward slowly, noting that the rate-reducing mechanism follows it.

(c) *Explanation.*—The expanding gases drive the slide to the rear with considerable force. The rear of the slide strikes the rate-reducing mechanism a hard blow, driving it to the rear and compressing the actuator spring. The slide then strikes the buffer head and sear release and is stopped without shock by means of the cups, cones, and buffer spring. The slide moves forward immediately and is engaged by the sear nose. In the meantime, the sear release has overcome its acceleration to the rear against the action of the actuator spring. The actuator spring drives the sear release forward and it cams down the rear of the sear, allowing the slide to go forward.

(d) *Set-up on board.*—The instructor should have an exhibit board showing a disassembled combination buffer and rate-reducing mechanism, and explain the functioning of the mechanism by means of this board.

■ 208. SPARE PARTS AND ACCESSORIES.—a. A piece of beaver-board 3 feet square with all the spare parts and accessories attached (see fig. 15).

b. *Procedure.*—(1) The instructor tells *why* and *how* the spare parts and accessories are carried; also gives use of each accessory.

(2) Ask questions.

■ 209. ADJUSTMENT OF THE GAS CYLINDER.—*a. Equipment.*—Same as in paragraph 204a plus combination tool.

b. Procedure.—(1) The instructor explains and has the assistant instructor demonstrate the correct method of adjusting the gas cylinder at each port.

(2) Each member of the team adjusts the gas cylinder correctly at each port.

(3) Ask questions.

■ 210. IMMEDIATE ACTION.—A member of the Browning automatic rifle team takes a firing position with the rifle (make sure that the firing pin has been removed). He places an empty magazine in the rifle and attempts to fire. The rifle fails to fire. What should the firer do? Answer: Immediate action—Immediately pull the operating handle to the rear, push the operating handle forward, tap up on the magazine, aim, and attempt to fire.

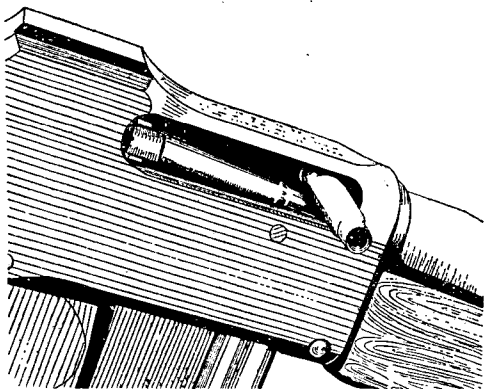
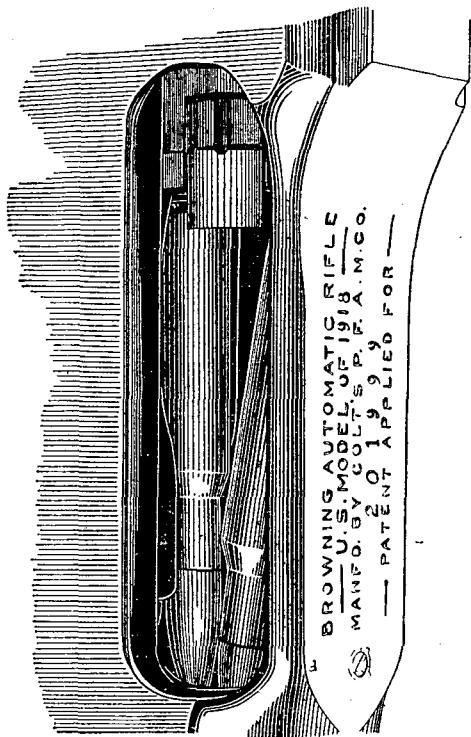

FIGURE 89.—Insufficient gas.

■ 211. STOPPAGE SET-UPS.—*a. Insufficient gas* (fig. 89).—Have an empty cartridge case protrude from the ejection opening with the base in the receiver; allow bolt to wedge the case in the ejection opening. Replace magazine. Answer: Insufficient gas—Set gas cylinder on next larger port. (This set-up may also be made by having a dummy cartridge wedging the empty round in the ejection opening).*

b. *Failure to feed* (fig. 90).—Place two dummy cartridges in the receiver with their noses wedged in the chamber by the bolt, or one dummy cartridge with bolt riding over it. Replace magazine. Answer: Magazine trouble—Change magazine.



①
FIGURE 90.—Failure to feed.

c. *Ruptured cartridge* (fig. 91).—Insert a dummy cartridge into a ruptured cartridge case, feed the dummy cartridge with the ruptured cartridge case attached into the chamber, and then allow the bolt to slam forward and jam the ruptured cartridge case in the chamber. Answer: Ruptured cartridge—If the ruptured cartridge case is not extracted with the dummy round when the operating handle is pulled to the rear, use the ruptured cartridge extractor to remove the ruptured case.

d. Single shot after application of first phase of immediate action.—What will cause the rifle to fire a single shot

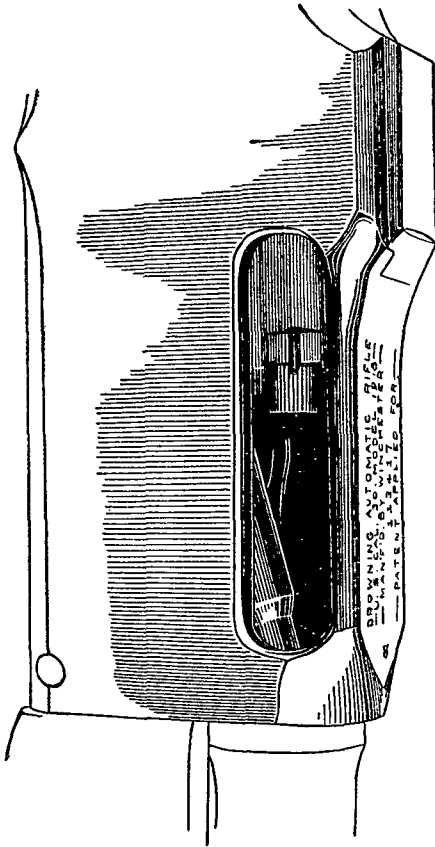

②
FIGURE 90.—Failure to feed—Continued.

after application of the first phase of immediate action?
 Answer: Faulty magazine or insufficient gas—Change the magazine and, if this does not correct the malfunction, set the gas cylinder on the next larger port.

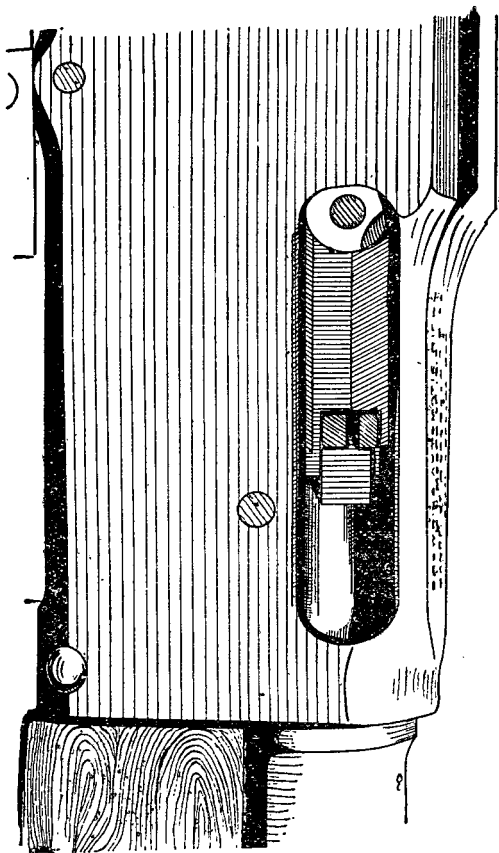

FIGURE 91.—Ruptured cartridge.

e. Failure to extract (rare) (fig. 92).—Place an empty cartridge in the chamber with a dummy cartridge attempting to get into the chamber. Answer: Faulty extractor or extractor spring—Change the extractor.

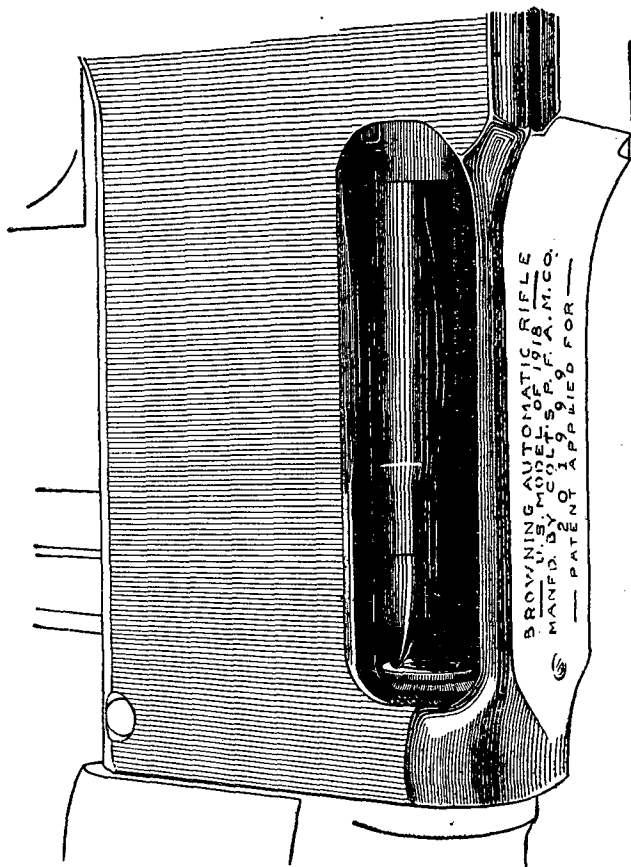

FIGURE 92.—Failure to extract.

SECTION II

MARKSMANSHIP, KNOWN DISTANCE TARGETS

■ 212. GENERAL.—*a.* Marksmanship is the basic step in training the automatic rifleman to employ his weapon in combat. An automatic rifleman will subconsciously apply in combat the fundamentals he has been taught in marksmanship, hence these fundamentals must be sound. *This fact should be kept uppermost in the mind of the instructor, and*

constant effort made to eliminate any artificialities which tend to creep in for the purpose of obtaining scores.

b. During instruction in the preparatory exercises, the entire unit is assembled in a suitable place (ravine or natural amphitheater), and attention focused on the instructor while he is giving the lecture and on the demonstration while it is being conducted. Following the demonstration, the teams move to their sets of equipment for practical work under the direct supervision of the assistant instructors.

c. Although not strictly a part of instruction in automatic rifle marksmanship, the soldier should be so trained as to be able to wear the gas mask over extended periods without material discomfort and attendant loss of battlefield efficiency. Therefore, this subject is considered to be directly related to proper physical conditioning for automatic rifle marksmanship, and subsequent training with the automatic rifle—field target firing exercises and combat training exercises. Extensive practice in having the soldier wear his gas mask while marching to and from the preparatory training area and the target range should be held.

■ 213. ASSISTANT INSTRUCTORS.—a. It is advantageous to have all officers and as many noncommissioned officers as possible trained in advance in the prescribed methods of instruction. When units are undergoing automatic rifle marksmanship training for the first time, this is not always practicable. A good instructor can give a clear idea of how to carry on the work in his lecture and demonstration preceding each step. In the supervision of the work following the demonstration, he should correct any mistaken ideas or misinterpretations.

b. When an officer in charge of automatic rifle instruction is to conduct successive organizations through the preparatory marksmanship training and range practice, it is advisable to attach officers and noncommissioned officers of following units to the organization taking the course of preparatory marksmanship training. These act as assistant instructors when their own units take up preparatory marksmanship training. Such assistants are particularly useful when one group is firing on the range and another is going through the preparatory exercises, both under the supervision of one instructor.

■ 214. **EQUIPMENT.**—*a.* A loud speaker will be found very useful in this instruction. All equipment used in the preparatory exercises must be accurate and carefully made. One of the objects of these exercises is to cultivate a sense of exactness in the minds of the men undergoing instruction. They cannot be exact with poor equipment.

b. The instructor should personally inspect the equipment for the preparatory exercises before the training begins. A set of model equipment should be prepared in advance by the instructor for the information and guidance of the organization about to take up the preparatory work. The sighting bars must be made as described, and the hole representing the peep sight must be absolutely circular. If the sights are made of tin, the holes should be bored by a drill. Good rear sights can be made for the sighting bars by using cardboard and cutting the holes with a punch of the type used for cutting wads for 10-gage shotgun shells. Silhouettes painted on a white background are not satisfactory. The silhouette targets from the M1 1,000-inch target pasted on tin or stiff backing make the best aiming points either for sighting and aiming exercises or for use in position and trigger manipulation exercises.

■ 215. **INSPECTION OF RIFLES.**—No man is required to fire with an unserviceable or inaccurate rifle. All automatic rifles should be carefully inspected far enough in advance of the period of training to permit organization commanders to replace all inaccurate or defective rifles. Automatic rifles having badly pitted barrels are not accurate and should not be used.

■ 216. **AMMUNITION.**—The best ammunition available should be reserved for record firing, and the men should have a chance to learn their sight settings with that ammunition before record practice begins. Ammunition of different makes and of different lots should not be used indiscriminately.

■ 217. **ORGANIZATION OF THE WORK.**—*a.* *In preparatory training.*—(1) The field upon which the preparatory work is to be given should be selected in advance and a section of it assigned to each group. The equipment and apparatus for the work should be on the ground and in place before the morning

lecture is given, so that each group can move to its place and begin work immediately and without confusion. Figures 93① and ② show suggested organizations for the work when a number of groups are undergoing instruction at the same time.

(2) Each company should be organized in two lines, facing away from each other. In this way the instructors, whose positions are normally between the lines, have all of their men under close supervision.

(3) The arrangement of the equipment is as follows (fig. 93①):

(a) On each line are placed the sighting bars and rifle rests at sufficient intervals to permit efficient work.

(b) Fifty feet from each line is placed a line of small boxes with blank paper tacked on one side, one box and one small sighting disk to each rifle rest.

(c) Two hundred yards from each line is placed a line of frames suitable for use in making triangles at 200 yards, one frame to each platoon. These frames have blank paper tacked or pasted on the front. A long-range sighting disk is placed with each frame. Machine-gun targets make acceptable frames for this work.

(4) In position and trigger manipulation exercises, targets should be placed at 1,000 inches and 200 yards (fig. 93②).

(5) When sufficient level ground is not available for the above arrangement, the organizations will have to vary from it in some particulars. It will nearly always be found, however, that all of the work, except making triangles at 200 yards, can be carried on in two lines.

b. In range practice.—(1) The range work should be so organized that there will be a minimum of lost time on the part of each man. Long periods of inactivity while awaiting a turn on the firing line should be avoided. For this reason, the number of targets available should be sufficient to accommodate the men on the range.

(2) As a general rule, six men per target is about the maximum and four men per target the minimum for efficient handling.

■ 218. MODEL SCHEDULES.—The following schedules are suggested for guides in a course in preparatory marksmanship and firing course A:

a. Preparatory training.

Subject	Time allotted (hours)	Day
Purpose of preparatory marksmanship training.....	¼	1st
First step: Sighting and aiming exercises—		
Explanation and demonstration.....	½	
First sighting and aiming exercise.....	½	
Sight blackening and second sighting and aiming exercise.....	¾	
Third sighting and aiming exercise.....	2	
Second step: Position exercises—		
Explanation and demonstration.....	½	
Gun sling adjustment; trigger slack; holding the breath; general rules for positions.....	½	
Prone position, bipod rest.....	1	
Sitting position.....	½	
Kneeling position.....	½	
Assault fire position.....	½	
Antiaircraft fire position.....	½	
Review of positions.....	1	2d
Sight setting and aiming exercises	1	
Third step: Trigger manipulation exercises—		
Explanation and demonstration.....	½	
Trigger manipulation exercise, prone position.....	1½	
Effect of wind; sight changes; use of score book ¹	1	
Changing magazine exercises.....	1	
Examination of all men by platoon leaders in all preparatory subjects and exercises ²	2	

¹ The use of the score book and effects of light and wind will be taken up with men who are not actually on the line undergoing instruction.

² Lack of proficiency disclosed by examination will be corrected at once by additional instruction.

b. Range practice, course A.

Subject	Time allotted (hours)	Day
Automatic fire exercises, 1,000-inch range.....	½	3d.
Exercises in replacing magazines.....	½	
Fire tables I and II (each score preceded by a simulated run for each man).	7	
Fire tables III and IV (each score preceded by a simulated run)...	8	4th.
Fire table V (each score preceded by a simulated run).....	4	5th.
Fire table VI (each score preceded by a simulated run).....	4	
Record practice (course A)—Fire table VII.....	8	6th.

NOTE.—The time allotted for firing the known distance range is based on six orders per target and a simulated run preceding each practice for each man.

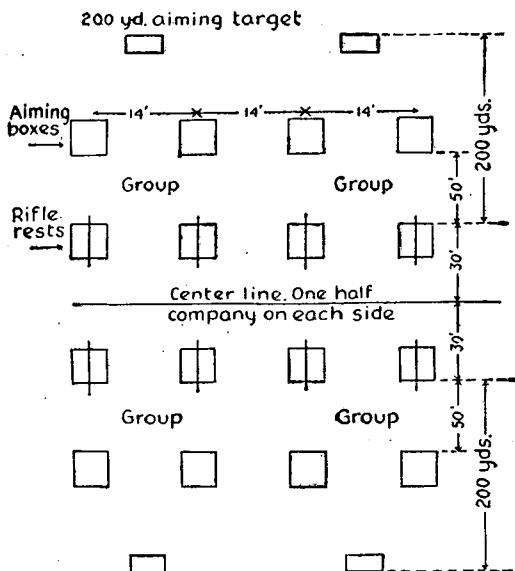

① Field lay-out for sighting and aiming exercises.

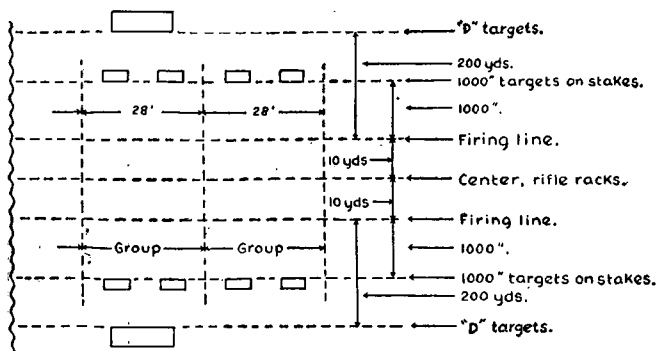

② Field lay-out for position and trigger manipulation exercises.

FIGURE 93.—Field lay-out for sighting and aiming, position, and trigger manipulation exercises.

c. For courses B, C, and D.—The preparatory exercises and 1,000-inch firing are the same as in course A. All other firing is conducted in a manner similar to course A, reducing the time accordingly.

■ 219. LECTURES AND DEMONSTRATIONS.—*a.* Lectures may be given at the beginning of each step of the instruction to the assembled automatic riflemen of the unit undergoing training to facilitate the work.

b. The notes on lectures which follow are to be used merely as a guide. The points which experience has shown to be the ones which usually require elucidation and demonstration are placed in headings in italics. The notes which follow each heading are merely to assist the instructor in preparing his lecture.

c. It is important to show the men undergoing instruction, by explanation and demonstration, just how to go through the exercises and to tell them why they are given these exercises.

■ 220. FIRST LECTURE: SIGHTING AND AIMING.—*a.* The group is assembled in a suitable outdoor location or in a building.

b. The following equipment is necessary for the demonstration:

- 1 sighting bar.
- 1 automatic rifle rest.
- 1 automatic rifle.
- 1 small sighting disk.
- 1 long range sighting disk.
- 1 small box.

Material for blackening sights.

c. The following subjects are usually discussed in the first lecture:

(1) *Value of automatic rifle fire.*—(a) The automatic rifle greatly increases the fire effect of the rifle squad.

(b) Individual proficiency consists in the automatic rifleman's ability to place a large volume of accurate fire upon appropriate targets.

(2) *Object of target practice.*—(a) To attain this individual proficiency.

(b) To show riflemen how to teach others.

(c) To train future instructors.

(3) *Method of instruction.*—(a) The instruction is divided into steps. The man is taught each step and practices it before going to the next step. When he has been taught all of the steps he is taken to the known distance range to apply what he has learned.

(b) Careful instruction in the various preparatory steps will be of material benefit in range practice.

(c) Explain coach and pupil method. Why used.

(4) *Reflecting attitude of instructor.*—If the instructor is interested, enthusiastic, and energetic, the men will follow his example.

(5) *Examination of men on preparatory work.*—Each man is examined in the preparatory work before going to the range. An outline of this examination is given in paragraph 80.

(6) *Method of marking blank form.*—Explain in blank form, paragraph 57e. Explain marking system by use of a blackboard, if available.

(7) *Five essentials to automatic rifle marksmanship.*

Correct sighting and aiming.

Correct position.

Correct trigger manipulation.

Correct application of automatic fire fundamentals.

Knowledge of proper sight adjustments.

(8) *Today's work.*—First step, sighting and aiming.

(9) *Demonstration of first sighting and aiming exercise.*—Require a previously trained group to demonstrate just how this exercise is carried on.

(10) *Blackening the sights.*—Explain why this is done and demonstrate it.

(11) *Demonstration of second sighting and aiming exercise.*—Require a previously trained group to demonstrate the second sighting and aiming exercise.

(12) *Demonstration of third sighting and aiming exercise.*—(a) Require a previously trained group to demonstrate the third sighting and aiming exercise.

(b) Show how the group is organized by the coach and pupil method so as to keep each man busy all the time.

(c) Discuss incorrect sight alinement, sight picture, and their effect on shot groups (fig. 94).

(13) *Long range shot group work.*—Show the class the dis for 200-yard shot group work. Explain how this work is carried on and why. Show some simple system of signals that may be used.

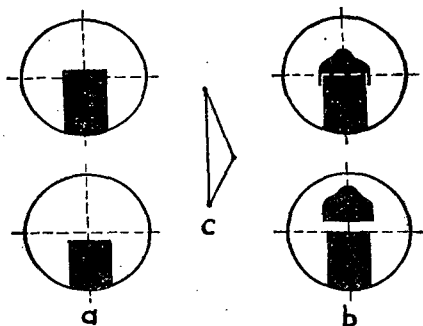

Front sight not exactly half way up in the peep. Silhouette not tangent to front sight.

Either type of error (a or b) will produce a triangle of the type c.

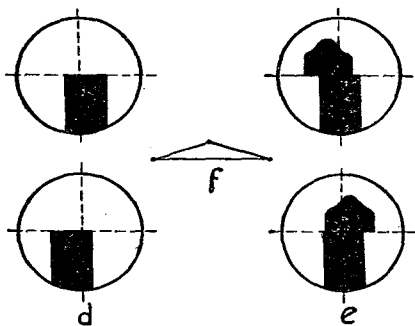

Front sight not centered from right to left in peep. Silhouette tangent to front sight but not at its mid-point.

Either type of error (d or e) will produce a triangle of the type f.

FIGURE 94.—Effect of incorrect sight picture.

(14) *Final word.*—(a) Start keeping your blank form today.

(b) Organize your work so that all men are busy at all times.

(15) Are there any questions?

(16) Next lecture will be ----- (State hour and place.)

■ 221. SECOND LECTURE: POSITION.—a. The following equipment is necessary for the demonstrations in this lecture:

1 automatic rifle with sling.

1 box with small aiming target.

b. The following subjects are the ones usually discussed in the second lecture:

(1) *Importance of each step.*—(a) Each step includes all that has preceded.

(b) Each step must be thoroughly learned and practiced or the instruction will not be a success.

(2) *Necessity for correct positions.*—Correct and comfortable positions are essentials of automatic rifle marksmanship. The prone position is especially important. Instruction in positions involves correct aiming.

(3) *Gun sling.*—State that the sling is used in the kneeling and sitting positions but not in the prone or in the anti-aircraft firing position. Demonstrate the adjustments of the loop and hasty sling and explain why they are used.

(4) *Taking up slack.*—Show the class the slack on the trigger. Explain why it is taken up in the position exercises. (Cannot begin to press the trigger until the slack has been taken up.)

(5) *Holding breath.*—Explain the correct manner of holding the breath and have the class practice it a few times. Explain how the coach observes the pupil's breathing by watching his back.

(6) *Position of thumb.*—May be either over the stock or on top of the stock but never along the side of the stock. Explain why.

(7) *Joints of finger.*—The trigger may be pressed with either the first or second joint of the index finger. However, it will be found that in firing single shots only a small percentage of men can successfully use the second joint of the finger.

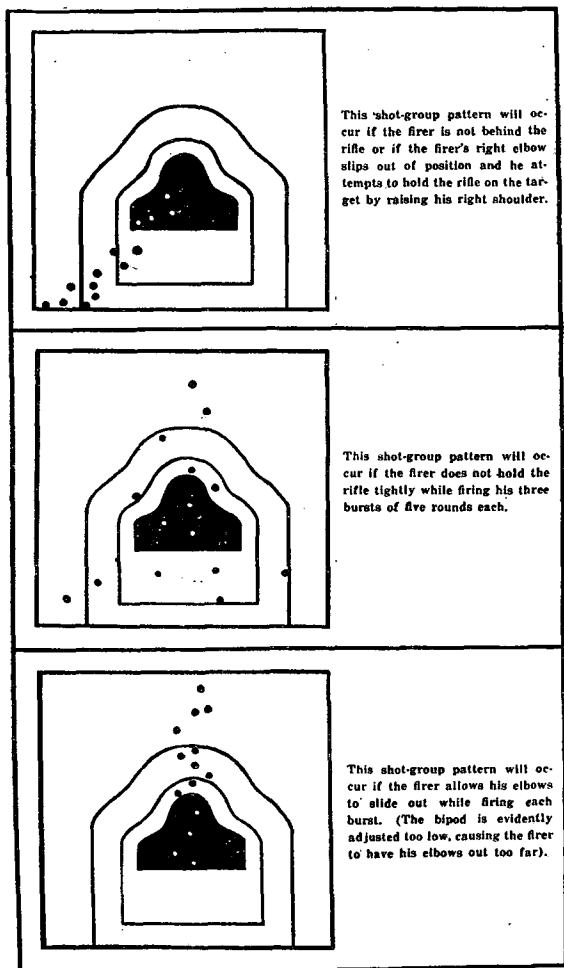

FIGURE 95.—Faulty shot patterns due to incorrect position.

(8) *Prone position.*—(a) Demonstrate correct prone position, calling attention to the elements which go to make up a correct prone position—body straight behind piece,

legs spread well apart, position of the butt on shoulder, position of the hands on the rifle, position of cheek against the stock, position of elbows. Demonstrate adjusting the bipod.

(b) Mention the usual faults which occur in prone position and especially the fault of having the body at an angle to the piece (fig. 95).

(c) Demonstrate the correct position again.

(9) *Sitting position*.—Demonstrate in the same manner as described above for the prone position.

(10) *Kneeling position*.—Demonstrate in the same manner as described above for the prone position.

(11) *Antiaircraft firing position*.—Demonstrate in the same manner as described above for the prone position.

(12) *Assault fire position*.—Demonstrate in the same manner as described for the prone position.

(13) *Today's work: position exercise*.—(a) Demonstrate the duties of a coach in a position exercise calling attention to each item (par. 63i).

(b) Demonstrate the positions of the coach, as described in paragraph 70.

(c) Show how the instructor organizes a group to employ the coach and pupil method so as to keep every man occupied.

(d) Continue the long range shot group work today.

(14) *Do not press trigger today*.—Take up the slack in these exercises but do not press the trigger.

(15) *Keep blank forms up-to-date*.—Examine each man in the group at the end of the day's work and assign him a mark.

(16) Are there any questions?

(17) Next lecture will be ----- (State hour and place.)

■ 222. THIRD LECTURE: TRIGGER MANIPULATION.—a. The following equipment is necessary for the demonstration:

1 automatic rifle.

1 box with small aiming target.

b. The following subjects are the ones usually discussed in the third lecture:

(1) *Methods of trigger manipulation*.—Explain that trigger manipulation for the automatic rifle differs materially

from the procedure employed in firing the Springfield or M1 rifle or the caliber .30 heavy machine gun. Marksmanship with the Browning automatic rifle, caliber .30, M1918A2, embraces two classes of fire, both of which are obtained by appropriate trigger manipulation with the automatic rifle set to fire at its slow cyclic rate. These two classes of fire and the trigger manipulation for each will be discussed separately.

(a) *Firing single shots.*—Single shots are fired by taking up the slack and pressing the trigger, being careful to maintain the alinement of the sights while the bolt is going home. An immediate release of the trigger is required when the bolt is released. Most men are able to attain this quick trigger release with a little practice. Explain to the group that if sometimes two or three shots instead of a single shot are obtained it makes no serious difference. Inform the group that in such event in qualification practice the several shots which are thus fired are included in the score. Explain that this is necessary because the weapon is not equipped with an adjustment for semiautomatic fire. Explain that single shots fired as explained above give a very effective form of field firing when it is necessary to conserve ammunition or for other tactical reasons.

(b) *Firing short bursts.*—Short bursts are fired by taking up the slack and pressing the trigger, retaining the pressure for the length of burst desired. Short bursts of two or three rounds are utilized in the marksmanship courses. Most men are able to manipulate the trigger to obtain such bursts with a little practice. Explain that these short bursts constitute the type of fire employed in the field when it is desired to take full tactical advantage of the fire power of this weapon. Explain that longer bursts would be seldom profitable in field firing and are not justified by the ammunition supply available to this weapon in the platoon.

(2) *Pulsations of body.*—In firing single shots in the sitting and kneeling positions, the natural movements of the body and its pulsations produce more or less parallel movement of the automatic rifle. These are not sufficient to affect the shot, and the alinement of the sights is maintained as steadily as possible without worrying about these small and natural

displacements of the aim as the trigger is pressed and the bolt is going home.

(3) *Aim and hold.*—Any man can easily learn to hold a good aim for 5 to 10 seconds, which is a much longer period than is necessary to fire a well-aimed single shot.

(4) *Calling the shot.*—Explain calling the shot and why it is done.

(5) *Today's work; trigger manipulation exercise.*—(a) Demonstrate the duties of a coach in the trigger manipulation exercises by calling attention to each item.

(b) The work is carried on as in position exercises with the pressing of the trigger added.

(c) Practice trigger manipulation for firing bursts and for firing single shots in the prone position only.

(d) Finish up the making of long range shot groups today.

(6) *Keep blank form up to date.*—Examine each man in the group at the end of the day's work and assign him a mark.

(7) Are there any questions?

(8) Next lecture will be ----- (State hour and place.)

■ 223. FOURTH LECTURE: REPLACING MAGAZINES AND AUTOMATIC FIRE.—*a.* The following equipment is necessary for the demonstration:

1 automatic rifle.

2 magazines.

1 target, United States rifle, caliber .30, M1.

b. The following subjects are the ones usually discussed in the fourth lecture:

(1) *Replacing magazine drill.*—(a) Explain how the exercise is carried on.

(b) Demonstrate and call attention to each item.

(2) *Meaning of automatic fire.*—Repeat the fact that automatic fire employs short bursts and the slow cyclic rate. Rapidity in sustained fire comes from skill in changing magazines.

(3) *Keeping eye on target.*—Explain the advantages of keeping the eye on the target while reloading and how it gains time.

(4) *Application in war.*—Explain the advantages of keeping the eye on the target in combat.

(5) *Automatic fire exercises.*—(a) Explain how the exercise is carried on.

(b) Demonstrate and call attention to each item.

(6) *Today's work; automatic fire exercise and replacing magazine drill.*—The remaining time today will be given to automatic fire exercises and drill in replacing magazines. The exercises will be repeated in short periods until each man is proficient.

(7) *Keep blank forms up-to-date.*—Examine each man in the squad at the end of the day's work and assign him a mark.

(8) Are there any questions?

(9) Next lecture will be ----- (State hour and place.)

■ 224. FIFTH LECTURE: EFFECT OF WIND AND LIGHT; SIGHT CHANGES; SCORE BOOK.—*a.* This part of the preparatory instruction can be given on any day on which the weather forces the work to be done indoors. If no bad weather occurs, this work should follow the fourth lecture.

b. The following equipment is necessary for the demonstrations:

1 D target (to be mounted on a frame and marked with the proper windage lines).

5 spotters that can readily be stuck into the target.

1 automatic rifle.

1 score book for each man.

c. The following subjects are the ones usually discussed in the fifth lecture:

(1) *Targets.*—(a) Explain the divisions on the target and give the dimensions of each.

(b) Call attention to windage lines. Have class compare them with diagram in the score book. Explain why lines are farther apart as the range increases.

(2) *Weather conditions.*—All weather conditions disregarded except wind.

(3) *Wind.*—(a) Explain how the direction of the wind is described.

(b) Explain how the velocity of the wind is estimated.

(c) Explain the effect of wind. This effect increases with the distance from the target.

(4) *Windage for first shot.*—Show windage diagram in the individual score book and explain its use as set forth in paragraph 76.

(5) *Windage-gage rule*.—State rule and explain it.

(6) *Elevation rule*.—State rule and explain it.

(7) *Light*.—Explain effect.

(8) *Score book*.—(a) Explain use of score book on range.

(b) Have class open score books and explain items of keeping score.

(9) *Exercises*.—Give the class a number of small problems as a demonstration as to how the day's work is to be carried on.

(10) *Today's work*.—(a) Study and practice in sight setting, sight changing, and use of score book. Instructors will work up problems for their groups.

(b) Additional practice in the exercises of the preceding days.

(11) Are there any question?

(12) Next lecture will be ----- (State hour and place.)

■ 225. **SIXTH LECTURE: RANGE PRACTICE**.—This lecture and demonstration should immediately precede range firing. If the class is not too large it should be given on a firing point of the rifle range.

a. The following equipment is necessary for the demonstrations:

Material for blackening sight.

1 automatic rifle with gun sling.

Corrugated type dummy cartridges (par. 18).

b. The following subjects are the ones usually discussed in the sixth lecture.

(1) *Preparatory work applied*.—Range practice is carried on practically the same as the preparatory exercises except that ball cartridges are used.

(2) *Coaching*.—Coach watches the man not the target. Coach does not keep the score for the pupil. Pupil must make his own entries in his score book. Coach sees that he does this.

(3) *Officers and noncommissioned officers*.—(a) Supervise and prompt the men acting as coaches.

(b) Personally coach pupils who are having difficulty in making good scores.

(4) *Spotters*.—Use in firing with and without time limit.

(5) Read safety precautions.

SECTION III

MARKSMANSHIP, AERIAL TARGETS

■ 226. PRELIMINARY PREPARATION.—*a.* The officer in charge of anti-aircraft training should be thoroughly familiar with the subject; should have sufficient officers detailed as assistant instructors; and should train the assistant instructors and a demonstration group before the first training period.

b. He should inspect the range and equipment in sufficient time prior to the first training period to permit correction of deficiencies.

■ 227. DESCRIPTION OF MINIATURE RANGE.—*a. Targets.*—(1) *Horizontal.*—This target is designed to represent a sleeve target towed by an airplane flying parallel to the firing point (figs. 35 and 42①).

(2) *Double diving and climbing.*—This target is in two sections. The right section is designed to represent a sleeve target towed so as to pass obliquely across the front of the firing line in the manner of an airplane diving, if run from left to right, or climbing, if run from right to left. The left section is the same but represents an airplane diving from right to left and climbing from left to right (figs. 35 and 42②).

(3) *Overhead.*—This target is designed to represent a sleeve target towed by an airplane which is approaching the firing line from the front and will pass overhead, or when run in the opposite direction represents an airplane that has passed over the firing line from the rear (figs. 36 and 42③).

(4) *Parachute.*—The target is designed to represent a parachutist descending vertically (figs. 37 and 46).

b. Size and speed of silhouette.—(1) The black silhouette of the horizontal and the climbing and diving target is a representation at 500 inches of a 15-foot sleeve at a range of 330 yards. It is 7.5 inches long. The speed of the silhouette should be not less than 15 feet per second. This speed represents that of an airplane flying 245 miles per hour at a range of 330 yards. The size and speed of the silhouette are based upon the time of flight of the caliber .22 bullet for 500 inches. This time of flight is approximately 0.04 second. When the target is moved at a speed of 15

feet or 180 inches per second, it will move 180×0.04 or 7.2 inches. Therefore, in order to hit the silhouette, the aim must be directed approximately one silhouette length (lead) in front of it. If two or three leads are used, the shot will hit in the appropriate scoring space. This does not hold equally true on the overhead target. If the shot is fired when the range is less than 500 inches from the firer, the required lead will be less than one target length.

(2) The black silhouette of the parachute target at 500 inches is a representation of a parachutist at a range of 300 yards. The target is operated at a speed of descent of 1 foot per second, which corresponds approximately to the angular travel of a parachutist descending 17 feet per second at a range of 300 yards. No lead is required to obtain hits on the black silhouette.

■ 228. PREPARATORY EXERCISES.—*a.* A method of conducting preparatory exercises is given in paragraph 144.

b. Each assistant instructor is assigned a target and conducts the preparatory training and firing of all groups on his target.

c. In preparatory training, coaches and pupils should change places frequently.

d. Forty-five minutes at each type of target should be sufficient to train each soldier in the preparatory exercises.

e. A detail of one noncommissioned officer and four or six men should be provided to operate each type of target except the parachute, which only requires one man.

■ 229. MINIATURE RANGE PRACTICE.—*a. Caliber .22 rifle.*—(1) The .22 caliber rifle, as issued, is equipped with a Lyman sight. The ordnance, upon request, will replace this Lyman sight with an open sight which is more practicable for anti-aircraft firing (par. 142c). However, the replacement of this sight is not necessary. If the aperture of the Lyman sight is unscrewed and removed from its frame, the frame itself can be used as a peep sight. This procedure is recommended as a time and labor saving expedient.

(2) Two magazines for each caliber .22 rifle should be provided.

(3) Ammunition should be available immediately in rear of the firing line at each type of target.

(4) Coaches should load magazines as they become empty.

(5) Scorers should be detailed for each type of target. After each score is fired, they score the target. They call off the number of hits made on each silhouette and pencil or chalk the shot holes. The coaches enter the scores on the firer's score card.

(6) A platform permitting the scorer to score the target should be provided for each type of target.

(7) To stimulate interest, the instruction can be concluded with a competition between individuals, squads, or training groups.

(8) If available, targets shown in figure 38 may be used on nonoverhead targets for group firing or competitions. One lead should be used in firing on this target.

(9) Considerable supervision is required in order to maintain target operation at the proper speed. Correct operation is required because the lead is based upon a speed of 15 feet per second.

(10) Safety precautions must be constantly observed.

b. Caliber .30 automatic rifle.—If the size of the danger area permits, the caliber .30 automatic rifle may be fired on the miniature range in the same manner as with the caliber .22 rifle, with the following exceptions:

(1) Use battle sight.

(2) The lead necessary to hit the black silhouette is approximately 2.5 inches. This is caused by the difference in the time of flight of the caliber .30 and caliber .22 bullets for 500 inches. The time of flight of the caliber .30 bullet for 500 inches is 0.015 second. When the target is operated at the speed of 15 feet per second, the silhouette will move approximately 2.5 inches during the time of flight of the bullet.

(3) Men must be constantly cautioned to keep the weight of the body forward.

(4) Preparatory exercises using the caliber .30 automatic rifle should precede firing that weapon. These exercises are conducted as explained for the caliber .22 rifle.

(5) The interval between individuals on the firing line should be increased. This may be accomplished by placing only one-half the group on the firing line at one time.

■ 230. TOWED TARGET (SLEEVE OR FLAG) AND RADIO-CONTROLLED PLANE TARGET FIRING.—*a. Range organization.*—(1)

Firing at a towed sleeve (flag) target or a radio-controlled plane target by an individual is impracticable and uneconomical. All firing is done by units of such size that fire can be readily controlled and directed. The platoon is the most convenient unit for such firing.

(2) An *ammunition line* should be established 5 yards in rear of the firing line. One small table for every 10 men in a firing group is desirable.

(3) Immediately in rear of the ammunition line the *ready line* should be established.

(4) The first platoon or similar group to fire is deployed along the ready line with each individual in rear of his place on the *firing line*. Other platoons or groups are similarly deployed in a series of lines in rear of the first unit to fire.

(5) Upon command of the officer in charge of firing, the group on the ready line moves forward to the firing line, securing ammunition en route; other groups close up.

(6) Upon completion of firing by one group, it moves off the firing line, passing around the flanks of the ready line so as not to interfere with the group moving forward.

(7) An ammunition detail sufficient to issue ammunition to groups as they move forward to the firing line and to collect unfired ammunition from the group which just completed firing should be provided. These two operations should be performed simultaneously. Unfired ammunition is delivered to the statistical officer.

(8) The officer in charge should have at least three assistants, two safety officers and one statistical officer.

b. Ammunition.—(1) Ball or tracer ammunition may be used. Tracer ammunition is useful to show the groups waiting to fire the size and density of the cone of fire delivered by the firing group.

(2) Tracer ammunition will assist the officer in charge of firing in verifying the lead announced in the fire order. It also provides a means of checking the firer's estimate of the lead ordered.

c. Technique of fire.—(1) *Leads.*—The lead used in the technique of fire described in paragraph 139 is the average of two theoretical extremes. For example: If the maximum slant range to a passing airplane is 600 yards and the minimum slant range is 300 yards, the lead used would be that

required for a slant range of 450 yards. Fire is delivered with one fixed lead in order to simplify the procedure. Experience indicates such technique is readily taught and that it is effective. This method will be taught in towed target range practice.

(2) The lead table given below may be helpful. It is based upon a 15-foot sleeve towed at 140 miles per hour and caliber .30, M2, ammunition. Since the average speed of the radio-controlled plane target is 95 miles per hour and its length is 10 feet, the leads listed below are equally applicable to this target.

Slant range (yards)	Lead required
100.....	2
200.....	3
300.....	5
400.....	7
500.....	10
600.....	12

The average of these is between six and seven leads. To hit a flag target 40 feet long, being towed at a speed of 165 miles per hour, requires an average of three leads.

d. Precautions.—Safety precautions as given in paragraph 241 must be rigidly enforced. This requires constant supervision by the officers in charge of firing.

e. Record.—The results of all firing should be recorded and analyzed. The statistical officer should record the total number of rounds fired and the hits obtained on each target. If the number of hits falls below the number expected, the reason should be sought and explained to the men. On the other hand, when results are satisfactory the men should be impressed with the value of rifle antiaircraft fire.

SECTION IV

TECHNIQUE OF FIRE

■ 231. GENERAL.—The instructor should secure necessary equipment, inspect ranges, and detail and train necessary assistants, including demonstration units, prior to the first

period of instruction. Instructors should use their initiative in arranging additional exercises in the application of the fundamentals and methods herein contained. It should be explained to trainees how the exercises used illustrate the methods in the technique of fire. Good work in the conduct of the exercises as well as errors should be called to the attention of all trainees.

■ 232. RANGE ESTIMATION.—*a.* A number of ranges to prominent points on the terrain should be measured so that a few minutes of each period can be devoted to range estimation.

b. Range cards as shown below will be of assistance in figuring percentage of errors.

■ 233. TARGET DESIGNATION.—*a.* The major portion of the time devoted to target designation should be spent on oral description. Simple designations should be required at first. The instruction should not be confined to the landscape panels.

b. An explanation should be made to the trainees as to why an angle of 50 mils will be subtended by 1 foot at 20 feet.

■ 234. AUTOMATIC RIFLE FIRE AND ITS EFFECT.—This step of instruction can best be covered by use of a blackboard and an automatic rifleman firing several bursts of tracer bullets to demonstrate the trajectories, danger space, dispersion, classes of fire, and related matters.

■ 235. APPLICATION OF FIRE.—*a.* Sufficient time and explanation should be devoted to the method of fire distribution to insure that all men fully understand it and can explain it in their own words.

b. A demonstration group can be used to show the technique employed in assault fire.

■ 236. LANDSCAPE TARGET FIRING.—*a.* An explanation and demonstration will be necessary to show the technique and procedure of zeroing rifles and the firing of exercises on the landscape targets.

b. Units should be given practical work in writing fire orders for targets on the landscape panels prior to their firing of any exercises.

■ 237. FIELD TARGET FIRING.—*a.* The most difficult factor in the preparation of problems for field firing is the selection of the terrain which complies with the safety regulations contained in AR 750-10. A drawing should be made on a

RANGE ESTIMATION

Name -----

Company -----

Squad -----

No.	Estimate	Correct	%	Remarks	No.	Estimate	Correct	%	Remarks
1					21				
2					22				
3					23				
4					24				
5					25				
6					26				
7					27				
8					28				
9					29				
10					30				
11					31				
12					32				
13					33				
14					34				
15					35				
16					36				
17					37				
18					38				
19					39				
20					40				

(Front)

TABLE FOR COMPUTING ERRORS IN RANGE ESTIMATION

Range in yards	Error in yards										
	5	10	15	20	25	30	35	40	45	50	100
250.....	2	4	6	8	10	12	14	16	18	20	40
275.....	2	4	5	8	9	11	13	15	16	18	36
300.....	2	3	5	7	8	10	12	13	15	17	33
330.....	2	3	5	6	8	9	11	12	14	15	30
350.....	1	3	4	6	7	9	10	11	13	14	29
380.....	1	3	4	5	7	8	9	11	12	13	26
400.....	1	3	4	5	6	8	9	10	11	13	25
420.....	1	2	4	5	6	7	8	10	11	12	24
440.....	1	2	3	4	6	7	8	9	10	11	23
460.....	1	2	3	4	5	7	8	9	10	11	22
480.....	1	2	3	4	5	6	7	8	9	10	21
500.....	1	2	3	4	5	6	7	8	9	10	20
520.....	1	2	3	4	5	6	7	8	9	10	19
540.....	1	2	3	4	5	6	7	8	9	10	19
560.....	1	2	3	4	4	5	6	7	8	9	18
580.....	1	2	3	3	4	5	6	7	8	9	17
600.....	1	2	3	3	4	5	6	7	8	8	17
620.....	1	2	2	3	4	5	5	6	7	8	16
640.....	1	2	2	3	4	5	5	6	7	8	16
660.....	1	2	2	3	4	5	5	6	7	8	15
680.....	1	1	2	3	4	4	5	6	7	8	15
700.....	1	1	2	3	3	4	5	6	6	7	14
720.....	1	1	2	3	3	4	5	6	6	7	14
740.....	1	1	2	3	3	4	5	6	6	7	14
760.....	0	1	2	3	3	4	5	5	6	7	13
780.....	0	1	2	3	3	4	4	5	6	6	13
800.....	0	1	2	3	3	4	4	5	6	6	13
850.....	0	1	2	2	3	3	4	5	5	6	12
900.....	0	1	2	2	3	3	4	4	5	6	11
950.....	0	1	2	2	3	3	4	4	5	5	11
1,000.....	0	1	2	2	3	3	4	4	5	5	10

NOTE.—Example of the use of this table: Suppose the correct range to be 695 yards and the estimated range to be 635. The "error in estimate" is consequently 60 yards. Select two "errors in estimate" in the 700-yard space (the nearest to the correct range given in the table) whose sum is 60 yards, as 50 and 10. Add the percentages shown thereunder, and the result will be approximately your error. In this case:

$$7 \text{ plus } 1 = 8\%$$

map showing all safety angles, target positions, and other required data.

b. The appearance of the ordinary prone or kneeling silhouette (E or F target) depends a great deal upon the direction of the sun, the background of the targets, and the angle at which the targets are placed. The effect of solidity can be obtained by using two figures placed at right angles to one another.

c. The firing should be controlled from a central location. Telephone communication between the firing point and the pits will facilitate this instruction. During this type of training the individuals of the team should approach and occupy the firing position with due regard to cover and concealment.

■ 238. TRANSITION FIRING.—*a. General.*—This phase of training gives the automatic rifleman practice in searching for targets, estimating ranges, and getting off an accurate burst quickly; and prepares him for combat firing exercises which follow later in his training.

b. Use of ranges.—(1) Ranges will vary greatly due to local conditions of space and terrain. There is no prescribed or exact arrangement of the lanes which constitute transition firing course ranges. Each range will require an organization for use adapted to its particular lay-out.

(2) A suggested arrangement (fig. 96), provides five lanes as shown, three lanes being used to fire the exercises in table I, and two lanes being used to fire the exercise in table II (par. 83e). If the above arrangement is impracticable, one or more lanes may be constructed in each of which all exercises of tables I and II are fired. This set-up may be accomplished by combining the set-up in lanes 1, 2, and 3 and adding the extra pits as indicated by the broken lines in figure 96.

(3) For the protection of the pit detail, individual open pits of the fox hole type (fig. 97) should be used; or for lanes 1, 2, and 3, trenches 18 feet long may be used.

(4) To control the raising and lowering of targets, telephone or radio communication between the firing points and pits is necessary. For lanes 1, 2, and 3, a telephone connection or radio is necessary only for the center pit. Targets in the other two pits may be controlled either orally or by attaching a piece of twine or wire to the arm of the operator

and extending it to the operator in the center pit. The wires are pulled when the targets are to be raised or lowered. For lanes 4 or 5, three telephones or radios will normally be required, one for each set of two pits. However, by ju-

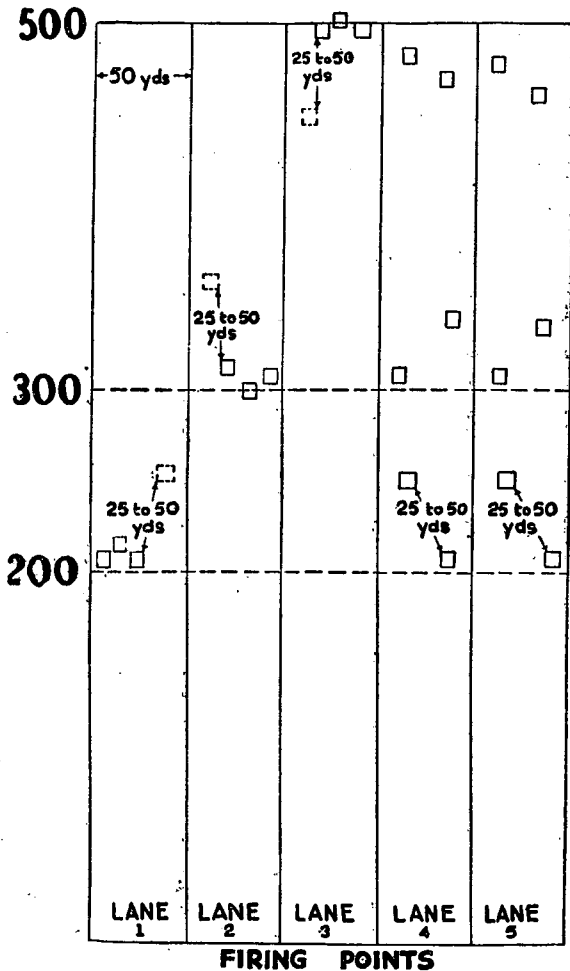

FIGURE 96.—Suggested lay-out for transition firing range.

ditional location of the pits, this number may be reduced to two.

c. Personnel.—Two officers should be used to control the firing at the firing points; one officer for the three firing points for the exercises of table I, and one officer for the two firing points used in firing the exercise of table II. One coach for each firing point, necessary pit details, and telephone orderlies or radio operators are required.

d. Procedure (see par. 88e).—(1) After the command **LOAD**, the officer in charge of firing gives the signal for raising the

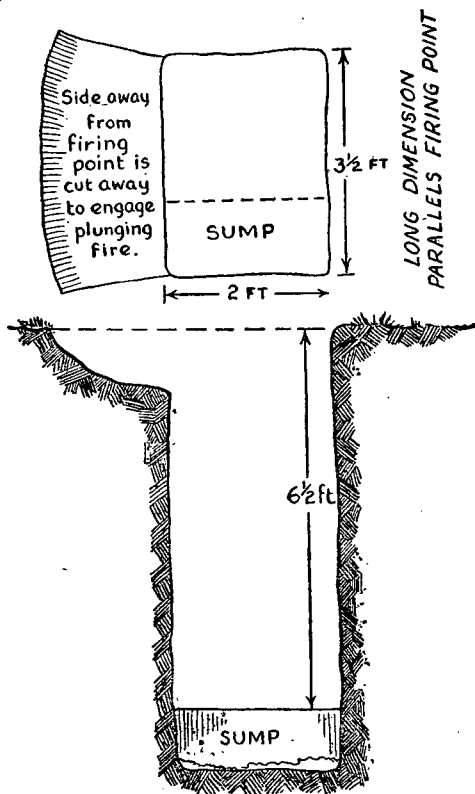

FIGURE 97.—Construction of open pit.

targets. The three lanes for table I may be operated together, and the two lanes for table II operated together. If this is not possible, lanes are operated independently of each other. When the signal is given, all targets are raised. Unless hit, they remain up until the signal to withdraw them is given.

(2) Each man should first fire the exercises in table I, and then progress to the exercise in table II. It is not necessary that the exercises in table I be fired in the order listed. In table II the firer may select any one of the three groups of two targets to fire on first. However, it is suggested that the course be fired by having the men start in lane 1 and progress through lanes 2 and 3 to either lane 4 or 5. This method permits the use of two men on the firing point in lane 1; one man fires while the other man goes through a dry run. Another arrangement would be to have three men fire the exercises in lanes 1, 2 and 3; and progressively change places until they have fired in all three lanes, and then move to lanes 4 or 5 where they fire the exercise in table II.

e. Ammunition allowances and scoring are based on firing bursts of two rounds each. Inasmuch as the scoring is indicated by the lowering of the target, no extra credit is given for more than one hit on a target. If two targets are hit by one bullet, both targets are scored. Also, there is no penalty for not firing a burst of two rounds, other than as indicated in the method of computing the score.

f. The course in transition firing for the automatic rifleman corresponds in time and procedure to the course for United States rifles, caliber .30, M1, M1903, and M1917 so that the automatic rifleman may be trained at the same time and on the same course as the riflemen of the squad.

■ 239. LOW VISIBILITY FIRING.—a. To deliver grazing (final protective line) or fixed (harassing) fire with the automatic rifle under conditions of low visibility, the following procedure must be accomplished in daylight:

(1) Determine the line on the ground along which the grazing fire is to be placed, or the point upon which fixed fire is to be placed, and then hold the gun in position so that the rifle can be fired along the line or at the point selected. (The stock rest may be used, as a convenience, to assist in holding the rifle.)

(2) Set the sight with zero windage and the estimated range to a point at the far end of the final protective line, if grazing fire is to be employed; or, the estimated range to the point, if fixed fire is to be used. Aim and hold the rifle on the point selected. With the automatic rifleman in position holding the automatic rifle motionless, the assistant automatic rifleman turns off full left (right) windage. The ammunition bearer, directed by the automatic rifleman, places an aiming stake on the new line of aim. The aiming stake is placed at such distance that an aiming point on the stake can be seen at night. The automatic rifleman, without moving the rifle, sights along the new line of aim and directs the ammunition bearer in placing a suitable marker on the stake in line with the sights to be used as an aiming point. A cleaning patch tied on the aiming stake makes a satisfactory aiming point. For grazing fire, the assistant automatic rifleman then raises the rear sight 2 mils in elevation to insure that the lower half of the cone of fire will not be lost by the bullets striking the ground short of the far end of the final protective line.

(3) Small stakes are next driven into the ground at the foot of each bipod leg to mark the position of the automatic rifle, so that if it is moved it may be replaced exactly in its former position. The use of stakes is applicable in the preparation of alternate and supplementary positions from which firing under conditions of poor visibility is to be done.

b. After the automatic rifle has been sited, and if the situation permits, the rifle should be fired for adjustment, and necessary sight corrections made. Sight settings are recorded for all positions prepared. See paragraph 201c for exercises in low visibility firing.

■ 240. POSITION DEFILADE FIRING.—*a. General.*—The automatic rifleman should be given instruction in firing from position defilade. The minimum and maximum ranges which can be used in this type of firing and still obtain good fire effect are, respectively, 700 and 900 yards. The adjustment of the fire and the consequent fire effect depend upon the observation of the strike of the bullets. Up to ranges of 900 yards, the effect of automatic rifle fire compares favorably with that of light and heavy machine guns. The stock rest is not used in firing from position defilade.

b. Positions.—The defiladed positions may be on the reverse slope of a hill or on a forward slope with an intervening hill in front. In either case, the ground from the position to the mask must have a gentle slope. The position selected must also have only sufficient deflade, so that a man in the kneeling or a lower position can see the target.

c. Siting for direction.—The initial direction of fire is obtained by the gunner raising his body to a position where he can see the target, alining the rifle on the target, and then selecting a weed or similar object to his front as an aiming point; or a stake may be placed in line with the rifle and the target. If traversing fire is to be used, two stakes to indicate the limits of traverse may be used. In firing from a forward slope, a visible terrain feature near or beyond the target is preferable.

d. Siting for elevation.—(1) If the defiladed position is on a reverse slope, set the sight at 300 yards elevation and, if the target is at 700 yards, then raise the sight 2 mils; if the target is at 800 yards, 4 mils; and if the target is at 900 yards, 6 mils. The gunner aims at the top of the mask or selected aiming point and fires a burst of five rounds. He then adjusts the fire as directed by the observer, preferably the ammunition bearer, who is in the kneeling or a lower position. Adjustment of the fire is made by the observer directing the gunner to shift the fire right, left, up, or down the necessary number of yards. The gunner then selects a new aiming point, which he estimates will place the next burst of five on the target, and fires again. Adjustment of the fire is made by selecting a new aiming point; changes in sight settings are not made. When the fire has been adjusted, bursts of two or three rounds are fired.

(2) If the defiladed position is on a forward slope, set the sight at the estimated range to the target, lower the elevation 3 or 4 mils, aim at the top of the mask or selected aiming point, and fire a burst of five rounds. Adjustment of the fire is then made as described in (1) above. If a visible aiming point such as a tree has been selected near or beyond the target, set the sight at the range to the target, estimate the height of the aiming point above the target in mils, lower the sight that amount, and aim at the selected aiming point. Fire an initial burst of five rounds, and then adjust as described in (1) above.

SAFETY PRECAUTIONS

■ 241. **OBSERVANCE.**—Safety precautions for observance by troops are self-contained and complete in this manual. Reference to AR 750-10 is necessary for range officers, the officer in charge of firing, and the commander responsible for the location of ranges and the conduct of firing thereon. All officers and men who are to fire or who are concerned with range practice or field firing must be familiar with *all safety precautions* listed in this chapter before firing is commenced.

a. General.—The safety precautions used at known distance ranges apply with equal force to instruction in firing at any field or aerial target. Safety of personnel is of primary importance in conducting exercises which require the firing of live ammunition. To this end, exercises should be drawn to conform to the state of training of the units concerned.

(1) The officer in charge of an exercise is responsible for the safety of the firing. It is his duty to initiate and enforce such precautions as he deems necessary under existing conditions. No other officer can modify his instructions without assuming the responsibility for the safety of the firing.

(2) Firing will not start nor will ammunition be issued until it has been ascertained that the range is clear, pit details are not exposed, and all *safety precautions have been complied with*. Upon completion of firing, rifles and belts must be inspected by an officer to insure that no ammunition remains in the possession of the men returning to camp or barracks.

b. Individual precautions.—(1) Consider every rifle to be loaded until it is examined and found to be unloaded. Never trust your memory as to its condition in this respect. Automatic rifles will be assumed to be loaded whenever a magazine is in the receiver or the bolt is to the rear.

(2) Never point the rifle in any direction where an accidental discharge may cause harm. When on the range, the rifle will be carried with the muzzle elevated at all times. During the firing of exercises, rifles will be pointed in the direction of the target at all times. (Special vigilance is required to enforce this rule while men are using cleaning rods to remove obstructions from the chamber.)

(3) Automatic rifles will be carried with the bolt forward at all times except in the presence of an actual enemy.

(4) Automatic rifles will not be carried loaded except in the presence of an enemy or simulated enemy. Loaded rifles will be carried with the muzzle elevated or pointed to the front.

(5) Never leave a patch, plug, or other obstruction in the muzzle or bore.

(6) Never fire a rifle with any rust-preventive compound, cleaning patch, dust, dirt, mud, snow, or other obstruction in the bore. To do so may burst the barrel.

(7) If the caliber .22 rifle is used, the bolt will not be forced home if difficulty in feeding is experienced. Attempting to force the bolt home may result in igniting a rim fire cartridge before the cartridge is seated in the chamber.

(8) Never grease or oil the ammunition. See that the ammunition is clean and dry. *Do not* expose it to the direct rays of the sun.

(9) Examine all live or dummy ammunition. Turn in all cartridges with loose bullets or which appear to be otherwise defective.

c. Range precautions.—(1) Danger flags will be displayed at prominent positions on the range during firing. Do not fire unless such flags are displayed.

(2) At least one officer will be present at all firing.

(3) Upon arrival at the range, the automatic rifles of an organization will be inspected by the officer(s) to see that the chambers and barrels are free from obstruction.

(4) All automatic rifles on the range except those in use on the firing line will have bolts in the forward position and magazines withdrawn. Rifles on the firing line will be loaded *only upon command* and, when loaded, the muzzles will be pointed in the direction of the target.

(5) All loading and unloading will be executed on the firing line with the muzzles directed toward the target. Rifles will never be loaded in rear of the firing line.

(6) Rifles are never to be pointed in such a direction that the fire will extend outside the prescribed limits outlined on the range.

(7) All firing must be controlled by suitable signals or commands. COMMENCE FIRING and CEASE FIRING must be given in such a manner as to be understood clearly and promptly by everyone engaged in firing. Firing will not begin on any

range until the officer in charge of firing has ascertained that the range is clear and has given the commands **LOAD** and **COMMENCE FIRING**. All firing will immediately cease and rifles will be set at "safe" (or cleared if ordered) at the command **CEASE FIRING**.

(8) No person will be allowed in front of the firing line for any purpose until directed by an officer who first orders all rifles to be cleared and ascertains that the order has been carried out. No rifles will be carried in front of the firing line.

(9) No automatic rifle will be removed from the firing line until an officer has inspected it to see that the bolt is in its forward position and the magazine is withdrawn.

(10) Before leaving the range, all rifles and belts will be inspected by an officer to see that they do not contain ammunition, and men will be questioned as to whether they have any ammunition in their possession.

(11) Target personnel will not leave the designated safety area until the signal or command to do so has been given.

(12) No magazine test or magazine drill will be conducted in rear of the firing line.

(13) See AR 45-30 for regulations covering report of accident involving ordnance matériel.

d. Precautions in firing at moving targets.—Additional safety precautions must be taken when exercises are being conducted in firing at moving targets.

(1) Firing at moving targets will not be permitted on any range until the safety angles have been carefully checked and markers have been placed so as to define clearly the right and left limits of fire.

(2) Personnel of trucks towing moving targets will operate at such distance from the line of fire as to be protected from direct hits and ricochets.

(3) Trucks replacing targets on the course, or personnel effecting repairs will be equipped with red flags.

e. Safety precautions for antiaircraft firing.—The following list of precautions must be taken when exercises are being conducted in firing at aerial targets. These, also, are in addition to the precautions listed in this paragraph.

(1) Towed target firing will be conducted with due regard for the safety of the pilot of the towing airplane, the personnel engaged in the firing, and all spectators.

(2) The signals or commands for COMMENCE FIRING and CEASE FIRING must be given at such time during the course of the flight of the target as to prevent any bullets from falling outside the danger area.

(3) In firing at towed targets, for all overhead flights, the signal or command for COMMENCE FIRING will not be given until the towing plane has reached a point 50 yards or less (measured horizontally on the ground) from the firing line, and there is no danger of bullets striking the plane. The signal or command for CEASE FIRING will be given before the sleeve target is 100 yards (measured horizontally on the ground) in advance of the firing line, in order that there will be no hazard of bullets dropping outside the firing area.

(4) All personnel will be warned that, in case a towing cable breaks and the towing airplane is on a course which passes near the firing point, they must lie flat on the ground until danger from the loose cable is passed.

(5) In firing at towed targets, no rifle will be pointed at or near the towing airplane. All tracking will be on the towed target. Muzzles will be depressed during loading.

(6) At least two safety officers will be designated to assist the officer in charge of firing in carrying out safety precautions.

(7) Firing at towed targets will be permitted only when the angle target-gun-airplane exceeds 300 mils or 17°.

(8) For the purpose of giving supplemental instruction and checking the safety measures taken, an air force officer should be at the firing point during an organization's initial practice for the season in towed target firing.

(9) No firing will be permitted at a slant range of less than 150 yards for any overhead flight of the radio-controlled plane target.

(10) As the radio-controlled plane target may get out of control, all men should be prepared to take cover upon the signal from the officer in charge of firing, the safety officers, or the target operator. Cover in the form of trenches or substantial obstacles must be provided for all personnel in case the target gets out of control and danger appears imminent. A loud, prearranged signal, such as a klaxon or siren, will be provided.

INDEX

	Paragraph	Page
Accessories	43, 208	45, 237
Advice to instructors	203	231
Aerial targets	160	160
Classification	137, 144	41, 130
Leads in firing	139	125
Marksmanship	226	258
Suitable for automatic rifle fire	136	124
Aiming and leading exercises	146	137
Alining front sight	89	96
Alining silhouettes and sights	61	59
Ammunition	44, 110, 216	48, 108, 244
Ballistic data	51	51
Care, handling, and preservation	49	51
Classification	45	49
Grade	47	49
Identification	48	49
Lot number	46	49
Storage	50	51
Antiaircraft fire:		
Delivery	142	127
Distribution	141	127
General technique	138	124
Leads	139	125
Marksmanship	143	129
Preparatory exercises	144, 228	130, 259
First step	145	136
Second step	146	137
Third step	147	139
Target designation	140	126
Position	68	70
Application of fire	182, 235	186, 263
Assault fire	184	194
Position	67	69
Assembling rifle	9, 204	9, 231
Assistant instructors	213	243
Automatic fire and replacing magazines	223	255
Automatic fire exercise	75	77
Automatic rifle fire:		
Effect	234	263
Importance	164	163
Fifth lecture	224	256
Ballistic data	51	51
Beaten zone	178	183
Bipod, adjusting	63	61
Breath, holding	63	61
Buffer and rate-reducing mechanism, functioning	22, 207	31, 233
Butt plate, hinged	63	61
Care and cleaning of rifle	13, 14, 206	16, 18, 233
Under unusual conditions	16	22
Care in disassembling and assembling	6	3
Change lever, to set	24, 34	34, 38

INDEX

	Paragraph	Page
Changing magazine, exercise in.....	74	75
Classes of fire.....	179	184
Cleaning.....	111	108
Coaches:		
Duties.....	59, 88	58, 95
Positions.....	70	72
Coaching.....	88, 144	95, 130
Prohibited.....	106	107
Concentrated fire.....	183	192
Connector, functioning.....	25	35
Courses, marksmanship.....	83	86
Courses to be fired, towed or radio-controlled plane target.....	153	147
Cover, use.....	200	218
Critique.....	201	223
Cycle of functioning.....	20	25
Description.....	21	26
Cyclic rate of fire.....	23	33
Danger space.....	175	181
Defilade, position, firing.....	240	270
Delivery of fire.....	142	127
Demonstrations.....	219	248
Destruction of ordnance matériel.....	202	228
Disassembling:		
Groups.....	205	231
Magazine.....	12	16
Rifle.....	8, 204	4, 231
Dispersion.....	176	181
Distributed fire.....	141, 183	127, 192
Dummy cartridges, use.....	18, 86	25, 95
Duties:		
Coaches.....	59, 88	58, 95
Leaders.....	57, 189	56, 199
Ejection.....	21	26
Elevation.....	77	78
Estimation by eye.....	170	165
Examination.....	80	79
Exercises:		
Aiming and leading.....	146	137
Automatic fire.....	75	77
Changing magazines.....	74	75
Field.....	201	223
Position.....	63	61
First step, antiaircraft fire.....	145	136
Preparatory, antiaircraft fire.....	144, 228	130, 259
Sequence of.....	96	100
Sight setting.....	71	72
Sight setting and aiming.....	72	73
Sighting and aiming.....	60-62	58
Situations for firing.....	201	223
Target designation.....	174	177
Trigger manipulation.....	73	74
Third step.....	147	139
Extraction.....	21	26
Extractor, to remove and replace without disassembling.....	11	14

INDEX

	Paragraph	Page
Failure to—		
Extract.....	211	238
Feed.....	211	238
Feeding.....	21	26
Field firing, antiaircraft.....	159	159
Field target firing.....	200, 237	218, 263
Scope of training.....	198	211
Terrain, targets, and ranges.....	199	211
Fifth lecture (effect of wind and light; sight changes; score book).....	224	256
Fire:		
Antiaircraft.....	136	124
Application.....	182, 235	186, 263
Assault.....	184	194
Classes.....	179	184
Concentrated and distributed.....	183	192
Control.....	187	196
Delivery.....	142	127
Discipline.....	186	195
Distribution.....	141	127
Effect.....	180	185
Automatic rifle.....	234	263
Importance of rifle.....	164	163
Observation.....	169	165
Orders.....	95, 188	100, 197
Rate.....	185	194
Technique.....	163, 231	163, 262
Fire power of rifle.....	3	1
Fire, rifle.....	35	39
Firer, shelter for.....	108	108
Firing:		
Antiaircraft, field.....	159	159
Exercises, situation for.....	201	223
Field target.....	198, 237	211, 263
Group, miniature range practice.....	151	145
Instruction, miniature range practice.....	150	142
Landscape target.....	190, 236	199, 263
Line, organization.....	100	102
Low visibility.....	239	269
Miniature range.....	229	259
On wrong target.....	119	109
Pin, to remove without disassembling.....	10	13
Points.....	87	95
Position defilade.....	240	270
Procedure.....	155	147
With time limit.....	104, 122, 123	105, 110
Without time limit.....	103	104
Radio-controlled plane target.....	152, 153	147
Sequence of.....	82	86
Towed target.....	152, 153	146, 147
Transition.....	238	266
First lecture (sighting and aiming).....	220	248
First sighting and aiming exercise.....	60	58
First step (antiaircraft position exercise).....	145	136
Fouling shots.....	114	108
Fourth lecture (automatic fire and replacing magazines).....	223	255
Front sight, to aline.....	89	96

INDEX

	Paragraph	Page
Functioning cycle-----	21	26
Functioning of—		
Buffer and rate-reducing mechanism-----	22	31
Connector-----	25	35
Rifle-----	17	25
Mechanical means-----	19	25
To demonstrate-----	207	233
Sear-----	26	36
Sear release stop-----	27	36
Spring-----	28	37
Trigger mechanism-----	23	33
Gas:		
Action-----	21	26
Adjustment-----	36, 209	40, 238
Insufficient-----	211	238
Gloves-----	113	108
Grade of ammunition-----	47	49
Group firing, miniature range practice-----	151	145
Groups, shot-----	62, 177	60, 181
Gun sling-----	63, 112	61, 108
Hinged butt plate-----	63	61
Hold-off method of aiming-----	132	119
Holding breath-----	63	61
Immediate action-----	41, 210	42, 238
Inspection of rifles-----	215	244
Insufficient gas-----	211	238
Instruction firing, miniature range practice-----	150	142
Instruction practice:		
On known distance range-----	92	99
On 1,000-inch range-----	91	98
Instruction to pilots for towing missions-----	161	161
Instructors:		
Assistant-----	213	243
Advice to-----	203	231
Instruments, use-----	107	108
Interrupted score-----	116	109
Kneeling position-----	66	164
Known distance range-----	92, 126	99, 113
Landscape target firing-----	236	263
Scope and importance-----	190	199
Weapons to be used-----	192	200
Leaders, duties-----	57, 189	56, 199
Leads-----	128, 129, 132, 139, 230	117, 118, 119, 125, 260
Lectures-----	219	248
Position-----	221	251
Replacing magazine and automatic fire-----	223	255
Sighting and aiming-----	220	248
Trigger manipulation-----	222	253
Wind and light, sighting changes, and score book-----	224	256
Light, effect-----	77	78
Load:		
Magazine-----	31	38
Rifle-----	32	38

INDEX

	Paragraph	Page
Locking.....	21	26
Lot number of ammunition.....	46	49
Low visibility firing.....	239	269
Magazine:		
Disassembly and assembly.....	12	16
To load.....	31	38
Magazines, exercise in changing.....	74, 223	75, 255
Marking.....	98, 102	101, 103
Marksmanship.....	52-54	53
Aerial targets.....	136, 143, 226	124, 129, 258
Courses.....	83	86
Fundamentals.....	53	53
Known distance targets.....	212	242
Equipment.....	214	244
Organization.....	217	244
Schedule.....	218	245
Moving ground targets.....	127-135	117
Object.....	52	53
Phases of training.....	54	53
Preliminary preparation, aerial targets.....	226	258
Preparatory training.....	55	54
Matériel, ordnance, destruction of.....	202	228
Mechanical means of functioning.....	19	25
Mechanical training.....	203	231
Miniature range.....	158	152
Description.....	227	258
Firing.....	229	259
Practice.....	148, 229	142, 259
Misses.....	117	109
Moving personnel, method of aiming at.....	132	127
Moving targets and ranges.....	134	121
Moving vehicles.....	129, 130	118, 119
Place in training.....	131	119
Nomenclature.....	7	3
Observation of fire.....	169	165
Officer, range.....	157	152
Operation of rifle.....	29	37
Oral target designation.....	173	170
Orders, fire.....	95	100
Ordnance matériel, destruction.....	202	228
Organization.....	5	3
Of firing line.....	100	102
Of work, known-distance marksmanship.....	217	244
On the range.....	85	94
Pads.....	84, 113	94, 108
Pit detail.....	85	94
Position:		
Antiaircraft fire.....	68	70
Assault fire.....	67	69
Defilade firing.....	240	270
Kneeling.....	66	69
Of coach.....	70	72
Prone.....	64	66
Second lecture.....	221	251
Sitting.....	65	68

INDEX

	Paragraph	Page
Position exercises.....	63	61
First step, antiaircraft fire.....	145	136
Position stoppage set-ups.....	211	238
Precautions:		
Range.....	135	123
Safety.....	241	272
Preliminary preparation, marksmanship, aerial targets.....	226	258
Preparation of targets.....	193	200
Preparatory exercises, antiaircraft.....	144, 228	130, 259
Preparatory marksmanship training.....	55	54
Duties of coaches.....	59	58
Duties of leaders.....	57	56
Equipment.....	56	54
Method of instruction.....	58	57
Procedure in firing.....	155	147
With time limit.....	104	105
Without time limit.....	103	104
Prone position.....	64	66
Radio-controlled plane target firing.....	152, 153, 260	146, 147, 260
Procedure.....	155	147
Safety precautions.....	154	147
Range:		
Estimation.....	282	263
Importance.....	166	164
Methods.....	167	165
Known distance.....	92	99
Miniature, aerial.....	158, 227	152, 258
Officer.....	85, 157	94, 152
1,000-inch.....	91, 124	98, 110
Practice.....	84	94
Object and scope.....	81	86
Organization.....	85	94
Sixth lecture.....	225	257
Precautions.....	135	123
Towed target.....	159	159
Ranges.....	126, 199	113, 211
Moving targets, and.....	134	121
Rate of fire.....	185	194
Record practice:		
Course D, 1,000-inch range.....	124	110
Regulations governing.....	94	100
Restrictions as to rifle.....	109	108
Rifle:		
Assembling.....	9, 204	9, 231
Description.....	2	1
Disassembling.....	8, 204	4, 231
Operation.....	29	37
Restrictions.....	109	108
To demonstrate functioning.....	207	233
To fire.....	35	39
To load.....	32	38
To unload.....	33	38
Rifles:		
Inspection.....	215	244
Zeroing-in.....	194	204
Ruptured cartridge.....	211	286

INDEX

	Paragraph	Page
Safety precautions-----	241	272
Schedules, model-----	218	245
Score book-----	79	79
Fifth lecture-----	224	256
Score interrupted-----	116	109
Score cards and scoring-----	101, 158	102, 152
Scoring-----	101, 156, 193, 196	102, 152, 200, 209
Sear, functioning-----	26	36
Sear release stop, functioning-----	27	38
Second lecture (position)-----	221	251
Second sighting and aiming exercise-----	61	59
Second step (antiaircraft aiming exercise)-----	146	137
Shelter for firer-----	108	108
Shot groups:		
Description-----	177	181
Long-range work-----	220	248
Making, in preparatory marksmanship-----	62	60
Shots:		
Cutting edge of silhouette or line-----	115	108
More than prescribed in time limit-----	123	110
To be included in score-----	118	109
Two on same target-----	120	109
Warming, fouling, and sighting-----	114	108
Sight changes-----	224	256
Sight setting and aiming exercise-----	72	73
Sight setting exercises-----	71	72
Sighting and aiming exercises-----	60-62	58
Sighting and aiming lecture-----	220	248
Sighting bar:		
Construction-----	56	54
First sighting and aiming exercise-----	60	58
Sighting disks-----	56	54
Sighting shots-----	114	108
Signals-----	162	161
Sitting position-----	65	68
Situations for firing exercises-----	201	223
Sixth lecture (range practice)-----	225	257
Slide, demonstration of-----	207	233
Sling, gun-----	63, 112	61, 108
Spare parts-----	42, 208	44, 237
Springs, functioning-----	28	37
Stoppages-----	38, 97	41, 101
Causes-----	39	41
Prevention-----	40	41
Set-ups-----	211	238
Storage:		
Ammunition-----	50	51
Rifles-----	15	21
Suggested exercises-----	201	223
Target:		
Description-----	173, 191	170, 200
Designation-----	140, 171, 173, 233	126, 169, 170, 263
Exercise-----	197	209
Importance-----	171	169
Oral-----	173	170
Details-----	99	101

INDEX

	Paragraph	Page
Target—Continued.		
Field, firing.....	199	211
Firing on wrong.....	119	109
Landscape, firing.....	236	263
More shots than prescribed.....	123	110
Two shots on same.....	120	199
Withdrawing prematurely.....	121	109
Targets.....	125, 199	112, 211
Aerial.....	136, 137, 144, 160	124, 130,
Aerial.....	136, 137, 144, 160	160
Men marking.....	98	161
Miniature aerial.....	158	152
Moving.....	129-135	118
Preparation.....	193	209
Towed or radio-controlled plane.....	152, 153, 230	146, 147,
		260
Team, action.....	182	186
Technique of—		
Antiaircraft fire.....	138	124
Moving target fire.....	130, 132	119
Fire.....	163, 231	163, 262
Scope.....	165	164
Telephones, use.....	105	107
Third lecture (trigger manipulation).....	222	253
Third sighting and aiming exercise (making shot groups).....	62	60
Third step (trigger press exercises).....	147	139
Topographical terms.....	172	176
Towed target:		
Firing.....	152, 153, 230	146, 147,
		260
Range.....	159	159
Signals.....	162	161
Scoring.....	156	152
Towing missions, instruction to pilots.....	161	161
Tracer bullets, use.....	168, 173	165, 170
Trajectory.....	175, 181	181, 186
Transition firing.....	238	266
Trigger:		
Action, demonstration.....	207	233
Manipulation, lecture.....	222	253
Manipulation exercise.....	73	74
Mechanism, functioning.....	23	33
Press.....	147	189
Two shots on same target.....	120	109
Unfired cartridges.....	122	110
Unload rifle.....	33	38
Unlocking.....	21	26
Warming shots.....	114	108
Wind and light, effect.....	224	256
Windage.....	76	78
Withdrawing target prematurely.....	121	109
Work, organization.....	217	244
Zero, explanation.....	78	79
Zero of rifle, to determine.....	90	97
Zeroing-in of rifles.....	194	204

BASIC FIELD MANUAL

BROWNING AUTOMATIC RIFLE CALIBER .30,
M1918A2CHANGES }
No. 1 }WAR DEPARTMENT,
WASHINGTON 25, D. C., 24 December 1943.

FM 23-15, 30 June 1943, is changed as follows:

■ 8. DISASSEMBLING THE RIFLE.—*a.*

* * * * *

(3) (Superseded.) (*a*) Butt plate assembly.

(b) Buffer tube from the receiver.

* * * * *

b. Sequence.

* * * * *

(4) (Added.) *Buffer and rate reducing group.*—Remove—

(a) Large butt plate screw.

(b) Small butt plate screw.

(c) Butt plate assembly.

(d) Stock retaining sleeve.

(e) Actuator spring.

(f) Actuator.

(g) Washer.

(h) Stock.

(i) Actuator tube and buffer cap assembly.

(j) Buffer spring.

(k) Four steel cones.

(l) Four brass cups.

(m) Buffer key.

(n) Sear release.

(o) Buffer head.

*The individual items in this change will be cut apart and pasted over the specific paragraphs or subparagraphs affected.

c. Method.

* * * * *

(4) (Added.) *Buffer and rate-reducing group* (fig. 3.1).—The disassembly of the buffer and rate-reducing group is habitually performed as a part of mechanical training. The procedure of disassembly is as follows: Lay the rifle on a table, barrel down, muzzle pointed away from the soldier, and remove the sling and trigger guard retaining pin and spring. Lift out the trigger group. With the screw driver end of the combination tool, unscrew the large butt plate screw (42) from the face of the butt plate assembly (44). Similarly, remove the small butt plate screw (43) from the lug on top of the butt plate assembly, and lift off the butt plate assembly. Insert the screw driver end of the combination tool into the slot in the end of the stock retaining sleeve (45) and turn counterclockwise while gripping the stock (49) of the rifle with the left hand. Remove in order: the stock retaining sleeve (45), the actuator spring (46), the actuator (47), and the stock (49). Next, take out the washer (48) from the stock retaining sleeve recess in the butt end of the stock. Using the small spanner of the combination tool on the buffer cap in the rear end of the buffer tube (fig. 3.2), unscrew and remove the actuator tube and buffer cap assembly (50) from the buffer tube. Using the forefinger, remove the buffer spring (51), the steel cones (52), and the brass cups (53). Push the buffer head (56) to the rear with the forefinger and remove it from the buffer tube. Remove the buffer key (54) and sear release (55) from the buffer head. The buffer tube is threaded into the receiver and should never be removed except for replacement or repair and then only by Ordnance (fig. 3.2).

[A. G. 300.7 (16 Oct 43).] (C 1, 24 Dec 43.)

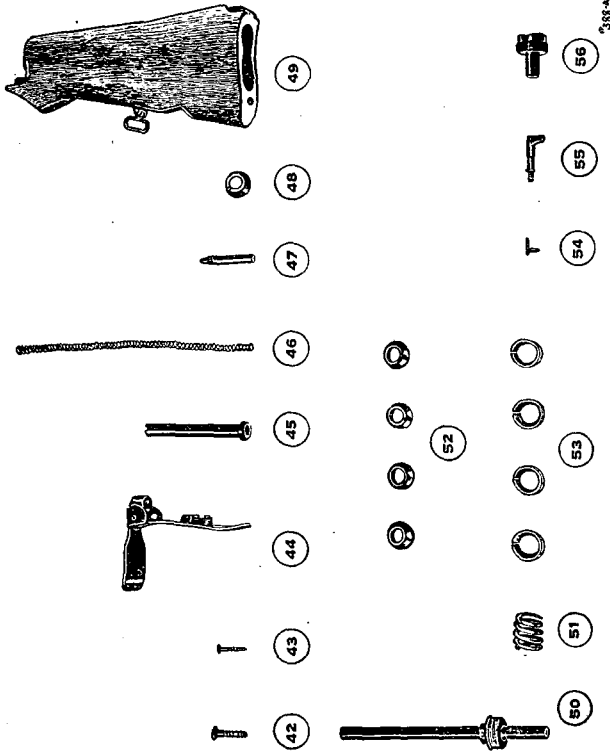

FIGURE 3.1.—Buffer and rate-reducing group.

[A. G. 300.7 (16 Oct 43).] (C 1, 24 Dec 43.)

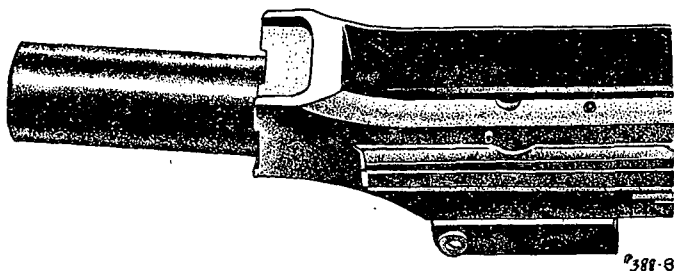

FIGURE 3.2.—Buffer tube and receiver.

[A. G. 300.7 (16 Oct 43).] (C 1, 24 Dec 43.)

■ 9. ASSEMBLING THE RIFLE.

* * * * *

d. (Added.) *Buffer and rate reducing group.*—Replace the sear release (55) and buffer key (54) into the buffer head (56) and then insert the buffer head into the buffer tube, using the forefinger as a guide. In seating the buffer head into its position in the buffer tube, care must be taken that the rounded portion of the sear release is directly toward the top of the receiver. Beginning with a brass cup (53), replace the four brass cups and four steel cones (52) alternately into the buffer tube. Replace the buffer spring (51) in the buffer tube. Screw the actuator tube and buffer cap assembly (50) clockwise into the buffer tube. Using the small spanner of the combination tool, securely tighten the actuator tube and buffer cap assembly into position. Replace the stock (49). Return the washer (48) to its seat in the stock retaining sleeve recess. Next, engage the tapered end of the actuator (47) in either end of the actuator spring (46). Then, with the actuator foremost, return the two parts into the actuator tube. Place the open end of the stock-retaining sleeve (45) over the actuator spring, and using the screw driver end of the combination tool, screw it tightly into position on the actuator tube. Turning the rifle barrel up, replace the butt plate assembly (44). Fasten the

butt plate assembly securely into position first by screwing the small butt plate screw (43) and then the large butt plate screw (42) into their respective seats. Turning the rifle barrel down, replace the trigger group and trigger guard retaining pin and spring.

[A. G. 300.7 (16 Oct 43).] (C 1, 24 Dec 43.)

■ 13. GENERAL.

* * * * *

b. *Lubricants, cleaning materials, and rust preventives.*

* * * * *

(2) *Oil, lubricating, preservative, light.*

* * * * *

(3) (Superseded.) *Oil, medium preservative, lubricating.*—This oil is superior to light preservative lubricating oil for small arms exposed to salt water atmosphere. It is heavier and possesses better preservative characteristics for such conditions. It contains rust inhibitors and forms a relatively heavy film, which resists the direct washing action of spray. These characteristics make it useful for coating all parts of the weapons prior to landing operations, and it should be used in preference to light preservative lubricating oil under such conditions. Use medium preservative lubricating oil only where the rifle is to be exposed to the conditions described in this paragraph. Under other conditions, use the lubricant prescribed in (2) above.

(3½) (Added.) *Oil, special preservative, lubricating.*—This is a thin oil chosen for lubricating at low temperatures and providing temporary protection against corrosion. Special preservative lubricating oil should always be used for preserving the bore between times when the rifle is fired. It is applied after the rifle has been cleaned. Frequent inspections should be made to assure maintenance of an adequate protective film of oil.

(4) *Oil, engine, SAE 10.*—This oil may be used when oils previously mentioned cannot be obtained. However, in cold * * * and reoiled frequently.

(5) *Compound, rust-preventive, light.*—This compound is * * * preheating is uneconomical.

* * * * *

[A. G. 300.7 (16 Oct 43).] (C 1, 24 Dec 43.)

■ 14. CARE AND CLEANING.—*a.*

* * * * *

(4) (Added.) The buffer and rate-reducing group is not normally disassembled each time the rifle is cleaned. It will be disassembled, cleaned, and lightly oiled only when such cleaning is necessary.

* * * * *

[A. G. 300.7 (16 Oct 43).] (C 1, 24 Dec 43.)

■ 15. STORAGE.—For preserving and lubricating materials, see paragraph 13*b*.

a. Preparation for storage.—Automatic rifles should * * * dried with rags. The buffer and rate reducing group should be disassembled, thoroughly cleaned, and then completely dried with rags. In damp climates, * * * the weapon to rust.

* * * * *

[A. G. 300.7 (16 Oct 43).] (C 1, 24 Dec 43.)

■ 16. CARE AND CLEANING UNDER UNUSUAL CONDITIONS.—*a. In cold climates.*—(1) For temperatures below * * * or complete failure. Oil must be applied *very* sparingly by wiping with a cloth which has first been wet with *special preservative lubricating oil* and then wrung out.

(2) The metal parts * * * below 0° F. The working surfaces of parts which show signs of wear may be lubricated by rubbing with a cloth slightly dampened with *special preservative lubricating oil* as prescribed in (1) above. At temperatures above * * * preservative lubricating oil.

* * * * *

c. Care when subject to gas attack.

* * * * *

(3) If contaminated, the following action will be taken:

* * * * *

(e) Decontaminate the rifle * * * solvent by volume. After decontamination, clean the matériel thoroughly and prepare for use as required.

(f) (Superseded.) For emergency decontamination of the automatic rifle, protective ointment M4 may be used. The application of this ointment and the decontamination procedure are as follows:

(1) Wipe dry of all liquid contaminants and bury or burn wiping material.

(2) Spread M4 ointment well over all metal, wood, and leather surfaces apparently contaminated, rub well, and allow to remain for 15 minutes.

(3) Wipe all surfaces dry of ointment.

(4) As soon as tactically permissible, disassemble the rifle, including the buffer and rate-reducing group, clean thoroughly, oil all metal parts, and reassemble.

* * * * *

[A. G. 300.7 (16 Oct 43).] (C 1, 24 Dec 43.)

■ 205. DISASSEMBLY AND ASSEMBLY OF GROUPS.

* * * * *

b. Procedure.

* * * * *

(4) The disassembly and assembly of the trigger group, buffer and rate-reducing group, bipod group, and magazine are carried on in the same manner as the operating group. Some instructors prefer * * * that specific group.

(5) During the practical * * * the next man.

(6) Ask questions.

[A. G. 300.7 (16 Oct 43).] (C 1, 24 Dec 43.)

BY ORDER OF THE SECRETARY OF WAR:

G. C. MARSHALL,
Chief of Staff.

OFFICIAL:

J. A. ULIO,
Major General,
The Adjutant General.